



# **ENERDOOR**

*Engineered by Finmotor*



## **The EMC Solution**

RoHS



5  year warranty

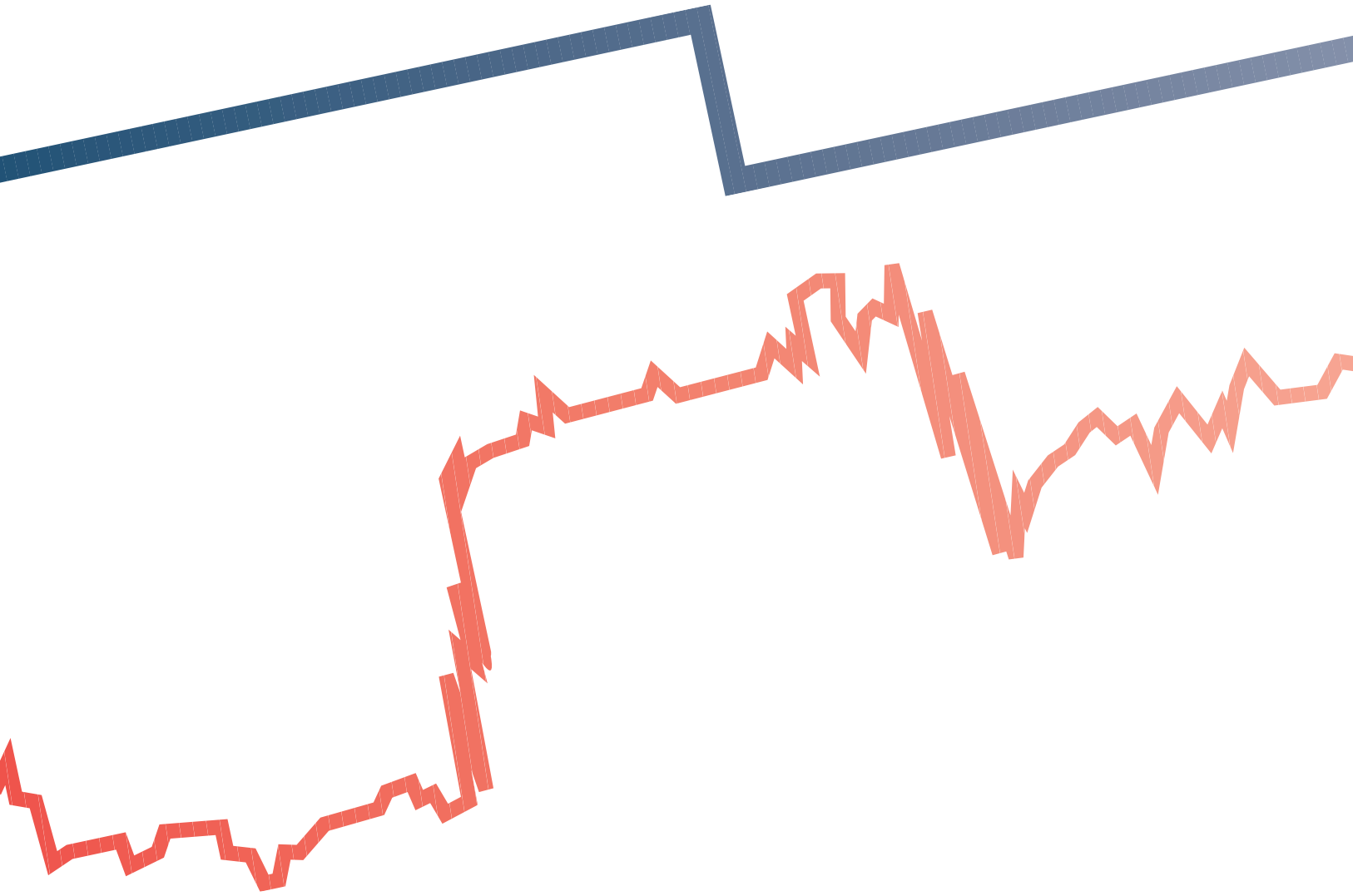



Company Overview	4
Enerdoor Compliance	5
Enerdoor Service	6
Product Overview	8

### SINGLE PHASE FILTERS

FIN21	14
FIN26	16
FIN27	18
FIN27G	20
FIN33	22
FIN35	24
FIN40	26
FIN50	28
FIN57	30
FIN60	32
FIN70	34
FIN80	36

### THREE PHASE PARALLEL FILTERS

FIN130SP	40
FIN230SP	40
FIN735	40
FIN730	42
FIN740	44

### THREE PHASE FILTERS

FIN1351	48
FIN538	50
FIN538S	52
FIN538S1	54
FIN539S	58
FIN1200	60
FIN1200HV	60
FIN1500	64
FIN1500HV	64
FIN1600	68
FIN1700	70
FIN1700G	72
FIN1700E	74
FIN1700EG	76
FIN1700IT	78
FIN1900	80
FIN1900G	82
FIN1900E	84
FIN1900EG	86
FIN1900S	88
FIN3755	90
FIN7213	92

### THREE PHASE + NEUTRAL FILTERS

FIN15	98
FIN1240	100
FIN1740	104
FIN1740ESM	106
FIN1940	108
FIN1940E	110

### DC FILTERS

FIN1220	114
FIN1220.0V	118
FIN1520	122
FIN1520.0V	126
FIN7212	130

### HARMONIC FILTERS

FINFF 230Vac	138
FINFF 400Vac	140
FINFF 480Vac	142
FINHRM	144
FINHRM5	146
FINHRMAD	151
FINSVG	153

### MOTOR PROTECTION

FIN900	160
FIN930	164
FIN950U	166
FIN5955	168
FIN958	170
FIN5980P	172
FIN5983	174
FIN960F	176
FIN905SF	178
FIN915SFH	182
FIN47SNB	186
FINSTP	188
FINTR	190
FINFE	190

### ACCESSORIES

FINPRT	192
FINENCL	193

Application Criteria	194
Application Diagrams	199
General Application	202

## ORDERING CODE

**FIN xxxx .yyy .z**

Model

Nominal Current

Connection

**B** = Bus Bar    **C** = Cable    **F** = Faston  
**M** = Terminal Blocks    **V** = Screws    **BC** = Bus Bar Compact



**Finmotor founded 1992**  
Rozzano, Italy



**Enerdoor/Finmotor headquarters**  
Milan, Italy

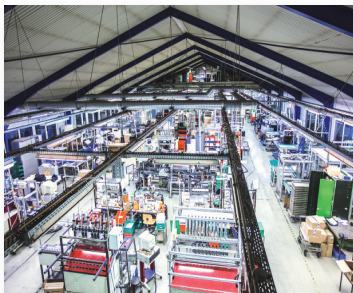

**Enerdoor/Eichhoff production facility**  
Vac, Hungary

The Enerdoor Group consists of Enerdoor in the United States, Germany and Switzerland; Finmotor and Finlab in Italy; and Eichhoff Elektro in Hungary.

Since 1992, The Enerdoor Group has been an international leader in the development and production of power quality and electromagnetic solutions for automated machinery and industrial plants. Enerdoor's broad range of products include: EMI/RFI filters, motor protection, harmonic filters, line reactors, surge arresters, voltage stabilizers, and customized solutions.

Advancements in power semiconductor technology in the 1970's eventually led to the development of the earliest variable frequency drives (VFDs) in Europe. VFDs are inherently "noisy", due to their high frequency switching characteristics. In response to market feedback, Enerdoor physicists and engineers created a broad range of filter solutions to resolve challenges caused by VFDs. Enerdoor filters turned out to be the perfect solution to meet the needs of the growing industrial equipment market.

With the increase of high frequency products used in the Industrial equipment market, it became clear that regulations would need to be established. CE compliance became a requirement in 1993. Due to Enerdoor's vision, the company was well positioned to become and continues to be one of the top suppliers in this growing market.

Enerdoor began operations in Portland, Maine in 2007. Organic growth led to Enerdoor expanding operations into Switzerland in 2007 and Germany in 2010. With the 2011 acquisition of the Hungarian transformer manufacturer, Eichhoff Elektro, Enerdoor has grown to be a global supplier, with manufacturing and R&D in four countries and a worldwide network of distributor and manufacturer representatives.

Enerdoor remains committed to providing the highest quality solutions and outstanding service to both customers and sales channel partners. Our ability to understand noise and diagnose the root causes of electrical noise, allows Enerdoor to recommend optimum solutions for the most challenging applications.

Enerdoor is committed to ensuring the production and delivery of high quality products. We strive to provide our customers with products and services that exceed expectations, while guaranteeing the best quality at all times.

Enerdoor products are CE approved with select series featuring UL approval for the US and Canadian markets. Enerdoor transformers and ignition systems are VDE approved.



**Eichhoff Elektro, a subsidiary of the Enerdoor Group, is an ISO-9001 Certified company. This Certification allows Enerdoor to maintain an excellent standard for internal quality and production control.**



### **Enerdoor Offers On-Site CE Compliance and Safety Testing**

An international leader in the development and production of EMI-RFI filters and power quality solutions for automated and industrial machines, Enerdoor additionally offers on-site CE compliance and safety testing.

Since 1992, Enerdoor has specialized in the measurement and analyses of EMC testing and CE Certification, providing on-site service to customers around the world through an efficient, global organization. Our flat rate testing service is unique in the industry, as is our pledge to not leave the facility until equipment is compliant.

Enerdoor service offers two fully equipped EMC mobile laboratories in Europe and two in North America. In addition, Enerdoor has an anechoic chamber located in Italy for small/medium equipment.

### **On-Site Compliance Testing**

The CE mark is an international reference for industrial and residential electronic applications. Enerdoor's on-site CE Certification testing specializes in the measurement and analysis of electromagnetic compatibility of systems in accordance with the EMC, FCC Part 15 and Safety Directives. The CE Directive dictates that all electric and electronic components in machinery and manufacturing plants must meet the minimum requirements indicated by the Directive.

Enerdoor engineers are able to assist customers through a portion or the entirety of the CE Certification process and provide filtering solutions to meet the conducted, radiated, and immunity test requirements. We work on-site with the customer to find real time solutions, and offer recommendations and suggestions to minimize potential radio-frequency interference that may cause malfunctions inside the machine or to other devices all for one flat-rate.

### **Testing, Support and Training Service**

Enerdoor is committed to ongoing investments, new technology solutions and excelling in the understanding of real-world power issues.

- Features an anechoic chamber and R&D facility
- CE Certification including machinery, safety and low voltage Directives
- EMC mitigation for CE and FCC compliance
- Power quality testing
- Low and high frequency disturbance problem solving
- Technical CE reports and final certificates
- Technical training for the Directive
- Product safety consulting
- Risk assessment
- ATEX consulting
- Seminars and technical training
- Ability to prepare necessary documentation for Technical Construction File (TCF)

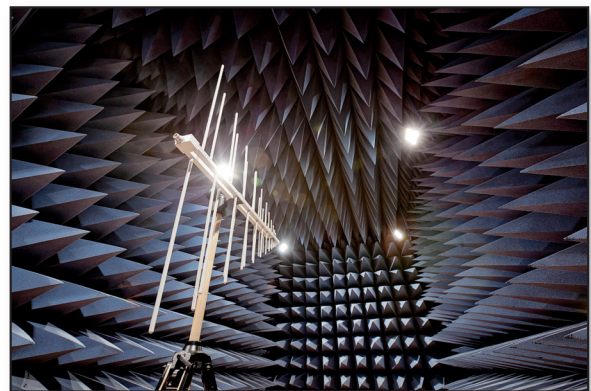



### Mobile Laboratories

Enerdoor mobile laboratories are available for EMC measurements directly at manufacturing plants or at the end users facility.

- Comply equipment with the EMC Directive
- Consultation and support for EMC problem solving
- Provide final test reports for completed tests
- Radio frequency disturbance analysis for single machines or entire plants
- Problem solving for disturbances generated by machines used in the manufacturer's plant
- Harmonic distortion analysis and solutions
- Disturbance analysis and solutions for the manufacturing plant/end user



### Power Quality Analysis

Enerdoor can assist customers performing power quality analysis on single machines or the complete plant. With several power quality analyzers, Enerdoor engineers can simultaneously monitor different drops in the same location.

A full report and recommendation of the best possible solution to eliminate the problem are offered at the end of the measurement period.

### Motor Analysis

Enerdoor offers motor analysis to customers experiencing premature failure on windings and bearings due to potential  $dV/dt$  issues. Enerdoor engineers determine the level of  $dV/dt$  using a differential voltage probe up to 5000V and a current probe on the motor. This service is available in all of Europe and North America.

This catalog features Enerdoor EMI/RFI filters, harmonic solutions and motor protection. Enerdoor also specializes in surge arresters, voltage stabilizers, and transformers as well as CE Certification and consulting services.



### Surge Arresters

Class I, I+II, II, II+III  
 Nominal voltage up to 690 Vac (1200 Vdc)  
 Surge capability up to 300 kA  
 Visual and remote contact indicator  
 DIN rail mounting

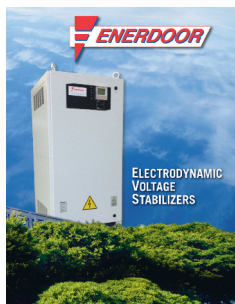

### Voltage Stabilizers

Single-phase stabilizer:  
 Nominal voltage up to 277 Vac  
 Rated power up to 320 kVA  
 Three-phase stabilizer:  
 Nominal voltage up to 600 Vac  
 Rated power up to 4000 kVA



### Transformers and Ignition Systems

Safety encapsulated transformer 0.35 to 100 VA  
 Primary voltage 0-600 Vac  
 Secondary voltage 1-48V  
 Electronic ignition system  
 High frequency ignition system

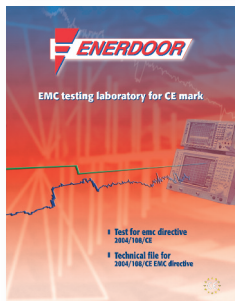

### CE Certification and Consulting

Mobile EMC testing  
 Machinery Directive and safety consulting  
 Problem solving in manufacturing plant  
 Power quality analysis  
 Motor analysis



### CE Certification and Consulting: Finlab - European Division

Mobile EMC testing  
 Anechoic chamber and EMC laboratory  
 Machinery Directive and safety consulting  
 Problem solving in manufacturing plants  
 Power quality analysis  
 Motor analysis

Enerdoor is an international leader in the design and manufacturing of standard and custom EMI/RFI filters.

## Introduction

Electromagnetic interference (EMI), or radio frequency interference (RFI), is a type of electric or electronic emission that can degrade, impair or prevent electrical circuit performance.

EMI filters are used to suppress interference generated by the device, or by other equipment, and to protect a device from electromagnetic interference signals present in the environment. Most EMI filters consist of components that suppress differential and common mode interference.

To protect and optimize equipment, Enerdoor EMI-RFI filters provide solutions in three product categories: single-phase, three-phase, and three-phase plus neutral filters.

## EMC Directive

Electromagnetic Compatibility (EMC) refers to the ability of equipment or systems to operate in an electromagnetic environment without introducing intolerable electromagnetic interference to anything in the environment. EMC includes two important aspects: emission and immunity.

**Emission:** The phenomenon by which the electromagnetic energy is emitted from a source such as a device, machine or system and shall not emit undesirable electromagnetic interference of a higher level than those allowed by the European EMC Directive 2014/30/EU (See Figure 1).

**Immunity (To Interference):** The capability of a machine, equipment or system to correctly operate without degrading functional characteristics when affected by electromagnetic interference.

Many countries have established regulations to minimize the radio-frequency interference between electronic equipment including: the CE mark in Europe, FCC in the United States, CCC in China, VCCI in Japan, RCM in Australia & New Zealand, and KCC in South Korea.

The global guideline for electromagnetic interference is the European Directive 2014/30/EU which requires that manufacturers of industrial machine tools and electric and electronic equipment comply with the electromagnetic compatibility emission and immunity Standards.

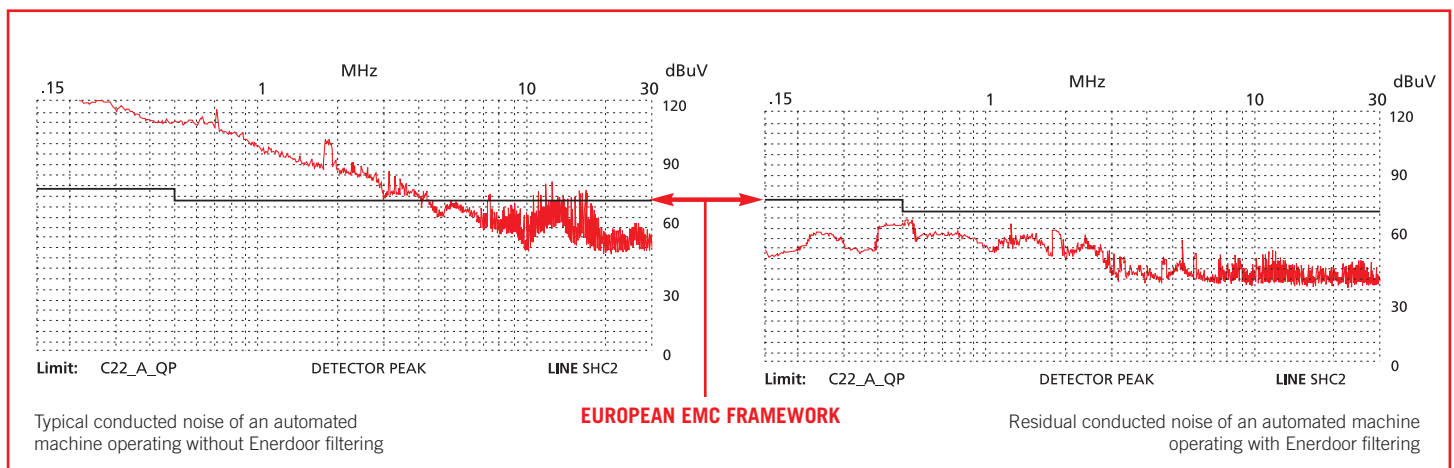

Figure 1:  
Example of typical high frequency disturbance generated by an automated machine operating without and with filtering necessary to comply with the European EMC Directive Framework 2014/30/EU limits.

## General Classification of Interference

### 1) Conducted and radiated interference

- a) Conducted interference is caused by the physical contact of undesirable voltage or current signals that enter or exit from a specific device through its own signaling or energizing electric conductors.
- b) Radiated interference is caused without physical contact of conductors. Every electric circuit acts as an aerial and when dipped in an electromagnetic field may induce voltage interference. Every variable current flowing in an electric conductor creates an electromagnetic field in its surrounding environment and similarly each electromagnetic field induces an electric signal in a close conductor.

### 2) Common mode and differential mode interference

Common mode interference is an undesirable signal measured between all conductors of an electric circuit connected together and a common reference, usually the earth (See Figure A).

Differential mode interference is an undesirable signal measured between two independent conductors of the same electrical circuit (See Figure B).

## Problems generated by EMI-RFI interference

- PLCs, sensors, encoders and PCs failing
- Decreased life of sensitive components
- Production downtime
- Disturbance in other buildings/machines

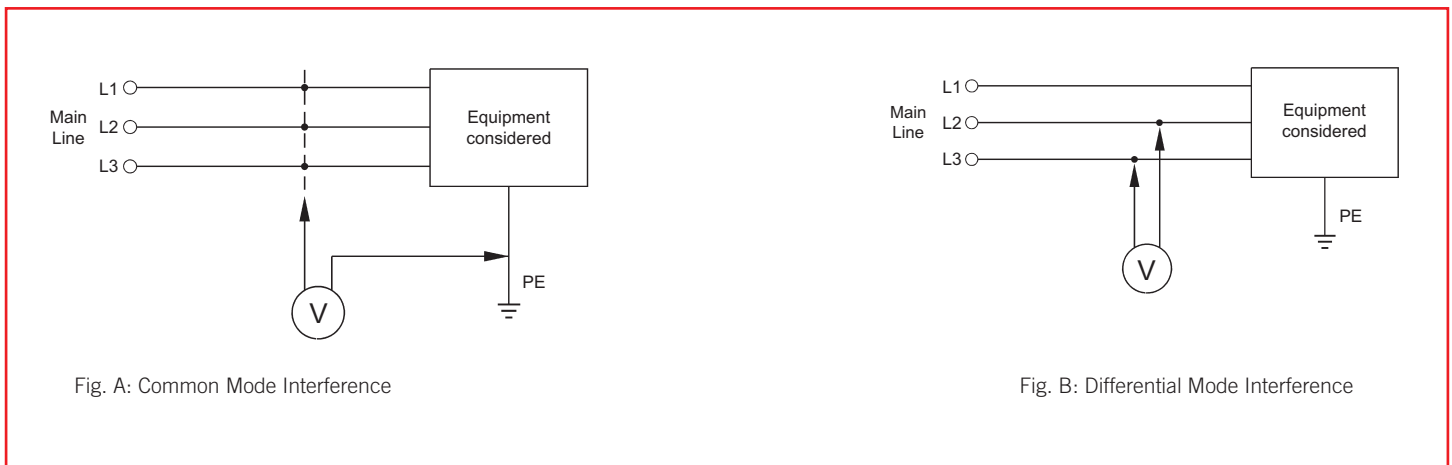

Figure 2:  
Diagram outlining difference between common mode and differential mode interference



## Interference Classification

### a) Conducted interference due to low frequency phenomena

- Mains 50/60 Hz harmonics and sub-harmonics
- Signaling systems
- Voltage variations, interruptions and dips
- Voltage unbalances
- Mains 50/60 Hz frequency variations
- Low frequency induced voltage
- DC components in AC

### b) Conducted interference due to high frequency phenomena

- Induced voltage or current (continuous or modulated waves)
- Voltage transients (bursts)
- Oscillatory transients (single or repetitive)

### c) Radiated interference due to low frequency phenomena

- Magnetic fields (transients or continuous)
- Electric fields

### d) Radiated interference due to high frequency phenomena

- Magnetic fields
- Electric fields
- Electromagnetic fields (transients, continuous or modulated wave)

## High Frequency Solution

To protect and optimize equipment performance, Enerdoor offers one of the largest ranges of solutions to reduce electromagnetic / radio-frequency interference. Offering a large variance of electrical and mechanical characteristics, Enerdoor EMI/RFI filters cover standard nominal voltage from 0 to 750 Vac with the following nominal currents:

**Single-phase** EMI/RFI filters: from 1 to 75A

**Three-phase** EMI/RFI filters: from 3 to 75A

**Three-phase plus neutral** EMI/RFI filters: from 3 to 3000A

**Parallel** EMI/RFI filters: In addition to the above EMI/RFI filter lines, Enerdoor offers a unique parallel filter solution. This line is designed for the specific frequency range of 50 kHz – 10 MHz where there is severe risk of interference and disturbance.

Filter Selection Guide	Description	Current Range (A)	Voltage	CONNECTORS						FEATURES						APPLICATIONS				Approval
				Faston	Terminal Blocks	Screws	Bus Bar	Cables	IEC Connector / Faston	Excellent Attenuation	DIN Rail Mount	Long Cable Applications	Low Frequency Attenuation	Compact Design	Suitable for Medical Applications	Power Supply	Automation	Renewable Energy / LED Lights	Medical	
Single Phase																				
FIN21	1-phase	3-20	0-250		X						X				X	X			X	UL US
FIN26	1-phase	3-20	0-250		X						X	X			X	X			X	UL US
FIN27	1-phase	3-20	0-250		X					X	X	X				X	X	X	X	UL US
FIN27G	1-phase	3-20	0-250		X					X	X	X	X		X		X	X	X	UL US
FIN33	1-phase	3-75	0-250	X		X								X	X	X				SP US
FIN35	1-phase	5-24	0-250	X	X			X							X		X			
FIN40	1-phase	5-24	0-250	X	X			X							X		X			
FIN50	1-phase	5-24	0-250	X	X					X		X					X	X		
FIN57	1-phase	6-25	0-250	X		X				X		X	X	X			X	X	X	
FIN60	1-phase	1-6	0-250						X						X	X				SP US
FIN70	1-phase	1-6	0-250						X						X	X				SP US
FIN80	1-phase	1-10	0-250						X						X	X				SP US

Single phase EMI/RFI filters are used to bring electrical and electronic products into compliance with national and international EMC Standards.

Enerdoor single phase filters carry CE, UL and CSA approvals and offer a current range from 1 to 75A with nominal voltage up to 250 Vac.

Additional select lines are available up to 690 Vac. For all models, a dedicated low leakage current solution is available for medical applications.

This series features various connections such as: IEC plugs, fastons, terminal blocks, cables, screws, and DIN rail mounting for fast and easy installation within the enclosure.

**Single phase EMI/RFI filter applications include:**

- Conveyors
- Automated machinery
- Variable frequency drives
- Servo drives
- Medical equipment
- Packaging machinery
- Printing machinery
- Renewable energy
- Power supplies

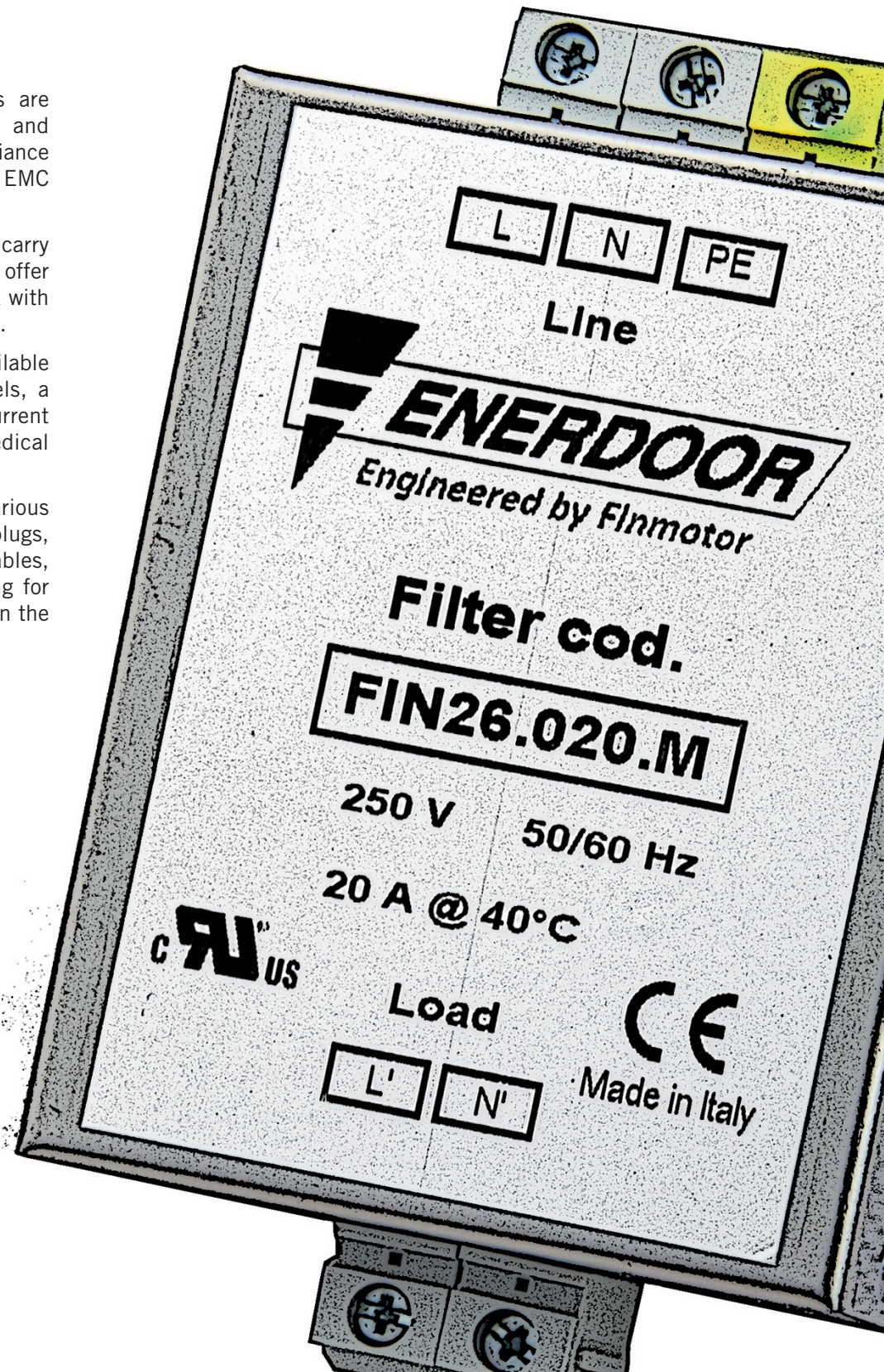





Datasheet 3/2019

### EMI/RFI Filter with high attenuation for industrial applications



**FIN21.(003 - 020).M**

#### FEATURES

- Rated current from 3 to 20A
- High differential and common mode attenuation
- Very low leakage current
- DIN rail mounting

#### MARKETS

- Conveyors
- Vending machines
- Industrial equipment
- PLCs

#### APPROVALS:



UL1283  
CSA C22.2



**SCCR** by UL508A

#### BENEFITS

- 5 Year warranty
- Suitable for medical applications
- Compact design

#### ORDERING CODE

FIN21	.016	.M
Model	Current (A)	Connection
		M = Terminal block

#### ATTENUATION INDICATOR

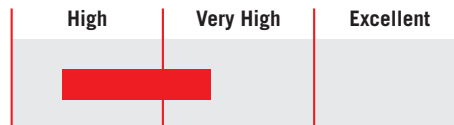

#### ELECTRIC DIAGRAM

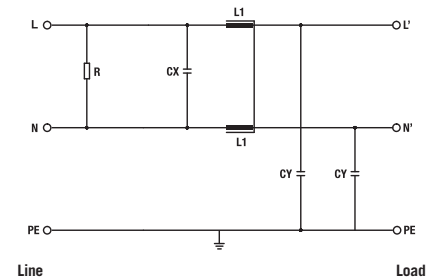

#### TECHNICAL SPECIFICATIONS

Nominal voltage	0 / 250 Vac
Frequency	50 – 60 Hz
Rated current	3 to 20A
Potential test voltage phase to phase	1750 Vdc (2 sec.)
Potential test voltage phase to ground	2150 Vdc (2 sec.)
Leakage current normal conditions	< 1 mA *
Leakage current worst conditions	< 3 mA
IP Protection	IP20
Overload capability	4 x Rated current (Switch ON) 2 x In 10 seconds 1.5 In for 10 minutes
Climatic class	-40 / +85° C
MTBF at 40°C	250.000 Hrs

\* Voltage 230 Vac phase to ground 50 Hz / 40°C



### ELECTRICAL CHARACTERISTICS

FIN21	Rated Current 40°C	Rated Current 50°C	Power Loss (W)
.003.M	3	2	1.5
.006.M	6	5	2.1
.010.M	10	8	2.8
.016.M	16	14	3.2
.020.M	20	17	4

### CONNECTIONS

LINE			PE
Solid Cable (mm <sup>2</sup> )	Stranded Cable (mm <sup>2</sup> )	Terminal Block Torque (Nm)	Torque (Nm)
0.2 - 6	0.2 - 4	0.8	0.8
0.2 - 6	0.2 - 4	0.8	0.8
0.2 - 6	0.2 - 4	0.8	0.8
0.2 - 6	0.5 - 4	0.8	0.8
0.2 - 6	0.5 - 4	0.8	0.8

### TYPICAL ATTENUATION

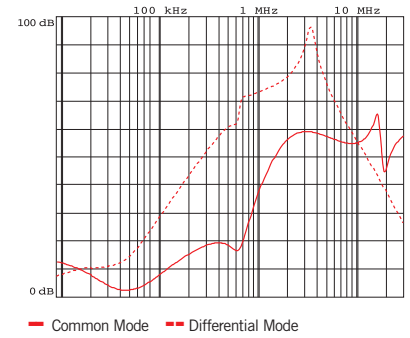

### MECHANICAL DIMENSIONS mm

FIN21	A	B	H	N	Weight Kg.	Case
.003.M	65	85	39	11	0.32	1
.006.M	65	85	39	11	0.32	1
.010.M	65	85	39	11	0.32	1
.016.M	65	85	39	11	0.32	1
.020.M	65	85	39	11	0.32	1

### CASE 1

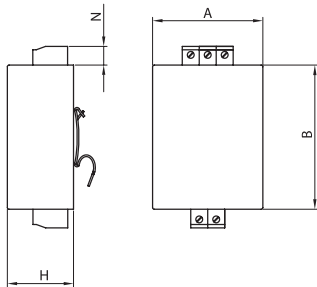

### ASSEMBLY CONNECTION "M"

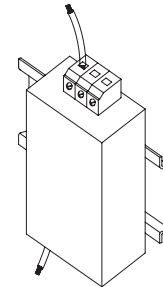



Datasheet 3/2019

### EMI/RFI Filter with very high attenuation for industrial and residential applications



**FIN26.(003 - 020).M**

#### FEATURES

- Rated current from 3 to 20A
- Very low leakage current
- DIN rail mounting
- Panel mounting available

#### MARKETS

- Conveyors
- Automated machinery
- Variable frequency drives / servo drives
- Medical equipment

#### APPROVALS:

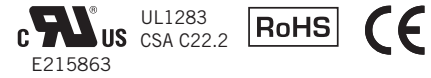

**SCCR** by UL508A

#### BENEFITS

- 5 Year warranty
- Suitable for medical applications
- Compact design
- Very high differential and common mode attenuation

#### ORDERING CODE

FIN26	.016	.M
Model	Current (A)	Connection
		M = Terminal block

#### ATTENUATION INDICATOR

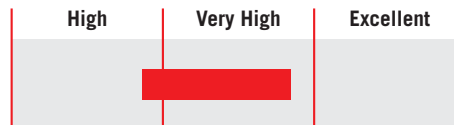

#### ELECTRIC DIAGRAM

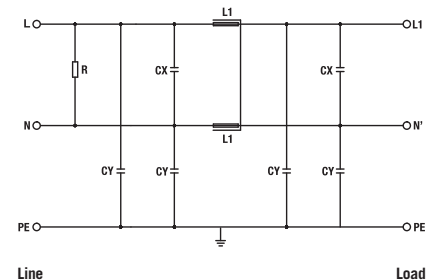

#### TECHNICAL SPECIFICATIONS

Nominal voltage	0 / 250 Vac
Frequency	50 – 60 Hz
Rated current	3 to 20A
Potential test voltage phase to phase	1750 Vdc (2 sec.)
Potential test voltage phase to ground	2150 Vdc (2 sec.)
Leakage current normal conditions	< 1 mA *
Leakage current worst conditions	< 3 mA
IP Protection	IP20
Overload capability	4 x Rated current (Switch ON) 2 x In 10 seconds 1.5 In for 10 minutes
Climatic class	-40 / +85° C
MTBF at 40° C	250.000 Hrs

\* Voltage 230 Vac phase to ground 50 Hz / 40° C

### ELECTRICAL CHARACTERISTICS

FIN26	Rated Current 40°C	Rated Current 50°C	Power Loss (W)
.003.M	3	2	1.5
.006.M	6	5	2.1
.010.M	10	8	2.8
.016.M	16	14	3.2
.020.M	20	17	4

### CONNECTIONS

LINE			PE
Solid Cable (mm <sup>2</sup> )	Stranded Cable (mm <sup>2</sup> )	Terminal Block Torque (Nm)	Torque (Nm)
0.2 - 6	0.2 - 4	0.8	0.8
0.2 - 6	0.2 - 4	0.8	0.8
0.2 - 6	0.2 - 4	0.8	0.8
0.2 - 6	0.5 - 4	0.8	0.8
0.2 - 6	0.5 - 4	0.8	0.8

### TYPICAL ATTENUATION

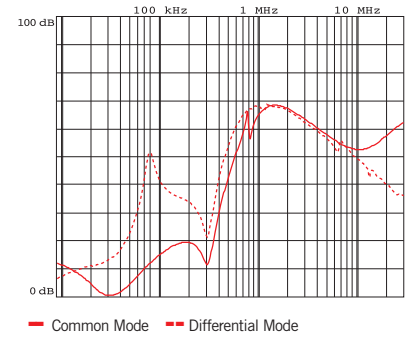

### MECHANICAL DIMENSIONS mm

FIN26	A	B	H	N	Weight Kg.	Case
.003.M	65	85	39	11	0.32	1
.006.M	65	85	39	11	0.32	1
.010.M	65	85	39	11	0.32	1
.016.M	65	85	39	11	0.32	1
.020.M	65	85	39	11	0.32	1

### CASE 1

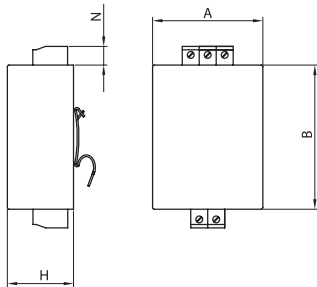

### ASSEMBLY CONNECTION "M"

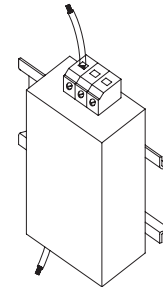



## EMI/RFI Filter with excellent attenuation for industrial and residential applications

Datasheet 3/2019



**FIN27.(003 - 020).M**

### FEATURES

- Rated current from 3 to 20A
- Low leakage current
- DIN rail mounting
- Panel mounting available

### MARKETS

- Automated machinery
- LED applications
- Variable frequency drives / servo drives
- Medical equipment

### APPROVALS:



UL1283  
CSA C22.2



**SCCR** by UL508A

### BENEFITS

- 5 Year warranty
- Excellent differential and common mode attenuation
- Compact design
- Helps pass industrial and residential Standards

### ORDERING CODE

FIN27	.016	.M
Model	Current (A)	Connection
		M = Terminal block

### ATTENUATION INDICATOR

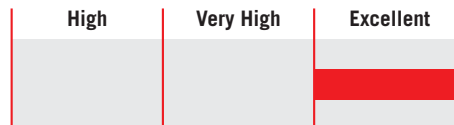

### ELECTRIC DIAGRAM

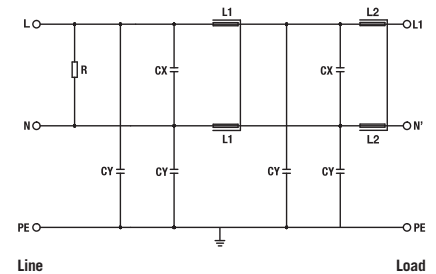

### TECHNICAL SPECIFICATIONS

Nominal voltage	0 / 250 Vac
Frequency	50 – 60 Hz
Rated current	3 to 20A
Potential test voltage phase to phase	1750 Vdc (2 sec.)
Potential test voltage phase to ground	2150 Vdc (2 sec.)
Leakage current normal conditions	< 1 mA *
Leakage current worst conditions	< 3 mA
IP Protection	IP20
Overload capability	4 x Rated current (Switch ON) 2 x In 10 seconds 1.5 In for 10 minutes
Climatic class	-40 / +85° C
MTBF at 40°C	250.000 Hrs

\* Voltage 230 Vac phase to ground 50 Hz / 40°C



### ELECTRICAL CHARACTERISTICS

FIN27	Rated Current 40°C	Rated Current 50°C	Power Loss (W)
.003.M	3	2	1.5
.006.M	6	5	2.1
.010.M	10	8	2.8
.016.M	16	14	3.2
.020.M	20	17	4

### CONNECTIONS

LINE			PE
Solid Cable (mm <sup>2</sup> )	Stranded Cable (mm <sup>2</sup> )	Terminal Block Torque (Nm)	Torque (Nm)
0.2 - 6	0.2 - 4	0.8	0.8
0.2 - 6	0.2 - 4	0.8	0.8
0.2 - 6	0.2 - 4	0.8	0.8
0.2 - 6	0.5 - 4	0.8	0.8
0.2 - 6	0.5 - 4	0.8	0.8

### TYPICAL ATTENUATION

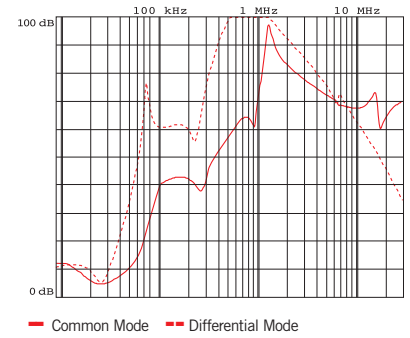

### MECHANICAL DIMENSIONS mm

FIN27	A	B	H	N	Weight Kg.	Case
.003.M	65	85	39	11	0.32	1
.006.M	65	85	39	11	0.32	1
.010.M	65	85	39	11	0.32	1
.016.M	65	85	39	11	0.32	1
.020.M	65	85	39	11	0.32	1

### CASE 1

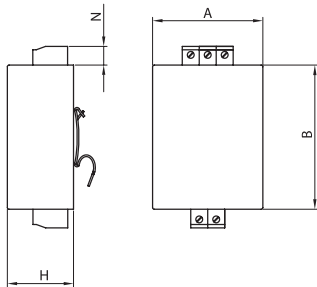

### ASSEMBLY CONNECTION "M"

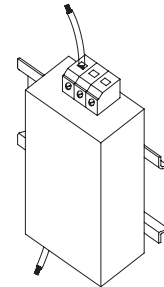



## EMI/RFI Filter with excellent attenuation for industrial, residential and medical applications

Datasheet 3/2019



FIN27G.(003 – 020).M

### FEATURES

- Rated current from 3 to 20A
- Low leakage current
- DIN rail mounting
- Panel mounting available

### MARKETS

- Automated machinery
- CNC machinery
- Variable frequency drives / servo drives
- Medical equipment

### APPROVALS:



SCCR by UL508A

### BENEFITS

- 5 Year warranty
- Excellent differential and common mode attenuation
- Compact design
- Designed for medical applications

### ORDERING CODE

FIN27G	.016	.M
Model	Current (A)	Connection
		M = Terminal block

### ATTENUATION INDICATOR

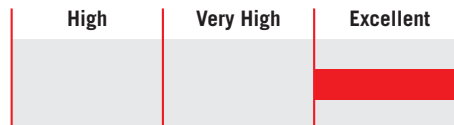

### ELECTRIC DIAGRAM

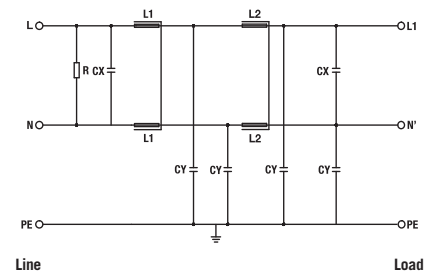

### TECHNICAL SPECIFICATIONS

Nominal voltage	0 / 250 Vac
Frequency	50 – 60 Hz
Rated current	3 to 20A
Potential test voltage phase to phase	1750 Vdc (2 sec.)
Potential test voltage phase to ground	2150 Vdc (2 sec.)
Leakage current normal conditions	< 0.4 mA *
Leakage current worst conditions	< 1.5 mA
IP Protection	IP20
Overload capability	4 x Rated current (Switch ON) 2 x In 10 seconds 1.5 In for 10 minutes
Climatic class	-40 / +85° C
MTBF at 40°C	250.000 Hrs

\* Voltage 230 Vac phase to ground 50 Hz / 40°C

### ELECTRICAL CHARACTERISTICS

FIN27G	Rated Current 40°C	Rated Current 50°C	Power Loss (W)
.003.M	3	2	1.5
.006.M	6	5	2.1
.010.M	10	8	2.8
.016.M	16	14	3.2
.020.M	20	17	4

### CONNECTIONS

LINE			PE
Solid Cable (mm <sup>2</sup> )	Stranded Cable (mm <sup>2</sup> )	Terminal Block Torque (Nm)	Torque (Nm)
0.2 - 6	0.2 - 4	0.8	0.8
0.2 - 6	0.2 - 4	0.8	0.8
0.2 - 6	0.2 - 4	0.8	0.8
0.2 - 6	0.5 - 4	0.8	0.8
0.2 - 6	0.5 - 4	0.8	0.8

### TYPICAL ATTENUATION

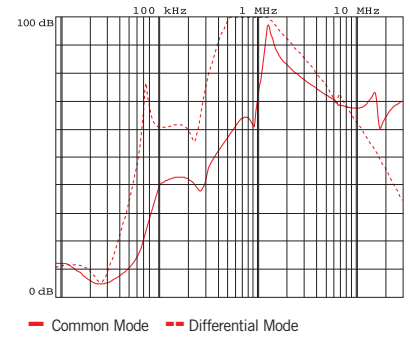

### MECHANICAL DIMENSIONS mm

FIN27G	A	B	H	N	Weight Kg.	Case
.003.M	65	85	39	11	0.32	1
.006.M	65	85	39	11	0.32	1
.010.M	65	85	39	11	0.32	1
.016.M	65	85	39	11	0.32	1
.020.M	65	85	39	11	0.32	1

### CASE 1

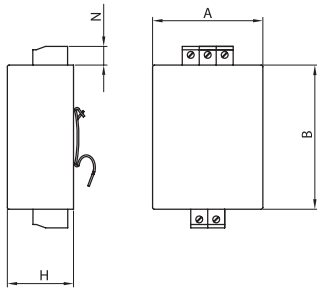

### ASSEMBLY CONNECTION "M"

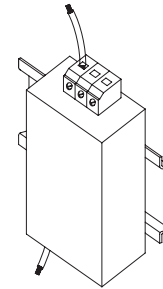



## EMI/RFI Filter with high attenuation for industrial and residential applications

Datasheet 3/2019

### APPROVALS:



**FIN33.(003 - 020).F**

### FEATURES

- Rated current from 3 to 75A
- Very low leakage current
- Faston connections
- Panel mounting

### BENEFITS

- 5 Year warranty
- High differential and common mode attenuation
- Very compact design
- Excellent quality and value

### MARKETS

- Conveyors
- Vending machinery
- Power supplies
- Medical equipment

### ORDERING CODE

FIN33	.020	.F
Model	Current (A)	Connection
		F = Faston
		V = Screws



**FIN33.(040 - 075).V**

### ATTENUATION INDICATOR

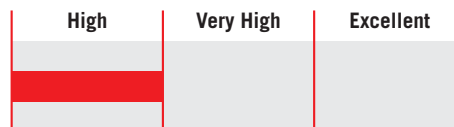

### ELECTRIC DIAGRAM

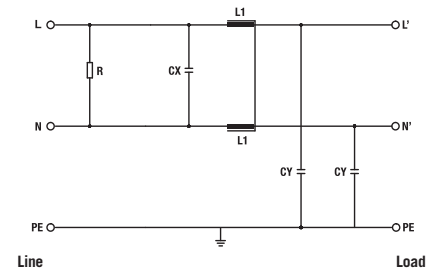

### TECHNICAL SPECIFICATIONS

Nominal voltage	0 / 250 Vac
Frequency	50 - 60 Hz
Rated current	3 to 75A
Potential test voltage phase to phase	1750 Vdc (2 sec.)
Potential test voltage phase to ground	2150 Vdc (2 sec.)
Leakage current normal conditions	< 1 mA *
Leakage current worst conditions	< 3 mA
IP Protection	IPO0
Overload capability	4 x Rated current (Switch ON) 2 x In 10 seconds 1.5 In for 10 minutes
Climatic class	-40 / +85° C
MTBF at 40°C	250.000 Hrs

\* Voltage 230 Vac phase to ground 50 Hz / 40°C

### ELECTRICAL CHARACTERISTICS

FIN33	Rated Current 40°C	Rated Current 50°C	Power Loss (W)
.003.F	3	2	1.5
.006.F	6	5	2.1
.010.F	10	8	2.8
.020.F	20	16	3.8
.040.V	40	32	4.5
.050.V	50	40	5.5
.075.V	75	60	7

### CONNECTIONS

LINE			PE	
Solid Cable (mm <sup>2</sup> )	Stranded Cable (mm <sup>2</sup> )	Terminal Torque (Nm)	d1 (mm)	Torque (Nm)
0.2 - 6	0.5 - 4	-	-	-
0.2 - 6	0.5 - 4	-	-	-
0.2 - 6	0.5 - 4	-	-	-
0.2 - 6	0.5 - 4	-	-	-
-	-	4	M5	4
-	-	6	M6	4
-	-	14	M8	4

### TYPICAL ATTENUATION

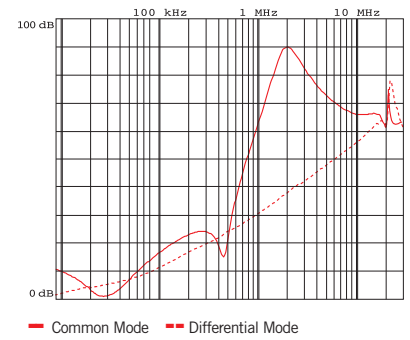

### MECHANICAL DIMENSIONS mm

FIN33	A	B	V	F	H	I	L	N	d	Weight Kg.	Case
.003.F	20.5	33	14	5	66	45	56	-	6.5	0.13	1
.006.F	20.5	33	14	5	66	45	56	-	6.5	0.13	1
.010.F	20.5	33	14	5	66	45	56	-	6.5	0.2	1
.020.F	39	51.8	14	5	84	65	74	-	6.5	0.18	2
.040.V	40	86.6	20	6x4	107	100	55	96	M5	0.18	3
.050.V	50	100	25	6x4	125	180	120	115	M6	0.30	4
.075.V	72	120	30	8x4	152	182	120	135	M8	0.40	5

#### CASE 1

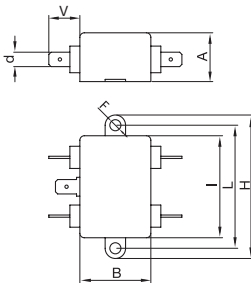

#### ASSEMBLY CONNECTION "F"

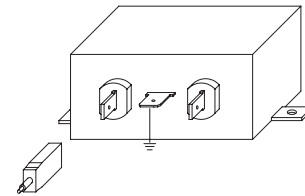

#### CASE 2

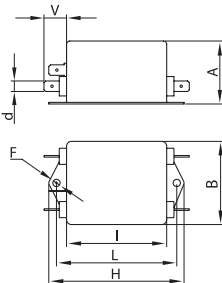

#### ASSEMBLY CONNECTION "F"

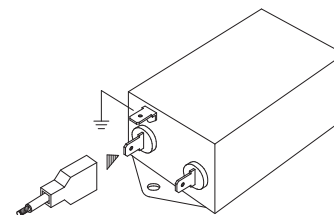

#### CASE 3, 4, 5

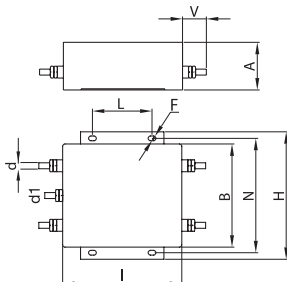

#### ASSEMBLY CONNECTION "V"

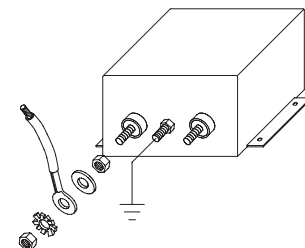





## EMI/RFI Filter with high attenuation for industrial applications

Datasheet 3/2019

**APPROVALS:**

**FIN35.(005 - 016).F**
**FEATURES**

- Rated current from 5 to 24A
- Low leakage current
- Faston connections
- Panel mounting

**BENEFITS**

- 5 Year warranty
- High differential and common mode attenuation
- Compact design
- Suitable for medical applications

**MARKETS**

- Automated machinery
- Medical equipment
- Power supplies
- Conveyors

**ORDERING CODE**

FIN35	.016	.F
Model	Current (A)	Connection
		F = Faston
		M = Terminal block

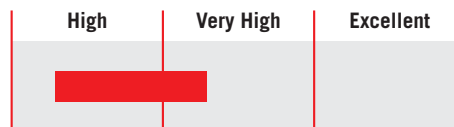
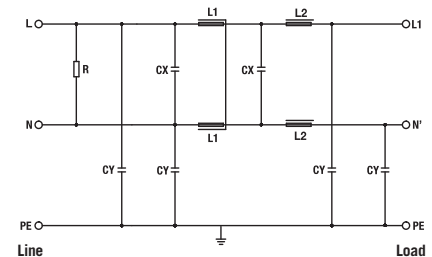
**FIN35.024.M**
**ATTENUATION INDICATOR**

**ELECTRIC DIAGRAM**

**TECHNICAL SPECIFICATIONS**

Nominal voltage	0 / 250 Vac
Frequency	50 – 60 Hz
Rated current	5 to 24A
Potential test voltage phase to phase	1750 Vdc (2 sec.)
Potential test voltage phase to ground	2150 Vdc (2 sec.)
Leakage current normal conditions	< 1 mA *
Leakage current worst conditions	< 3 mA
IP Protection	IPO0 up to 16A – over IP20
Overload capability	4 x Rated current (Switch ON) 2 x In 10 seconds 1.5 In for 10 minutes
Climatic class	-40 / +85° C
MTBF at 40°C	250.000 Hrs

\* Voltage 230 Vac phase to ground 50 Hz / 40°C

### ELECTRICAL CHARACTERISTICS

FIN35	Rated Current 40°C	Rated Current 50°C	Power Loss (W)
.005.F	5	3	2
.010.F	10	7	2.7
.016.F	16	12	5
.024.M	24	20	6

### CONNECTIONS

LINE			PE
Solid Cable (mm <sup>2</sup> )	Stranded Cable (mm <sup>2</sup> )	Terminal Block Torque (Nm)	Torque (Nm)
0.2 - 6	0.5 - 4	-	-
0.2 - 6	0.5 - 4	-	-
0.2 - 6	0.5 - 4	-	-
0.2 - 6	0.5 - 4	0.8	0.8

### TYPICAL ATTENUATION

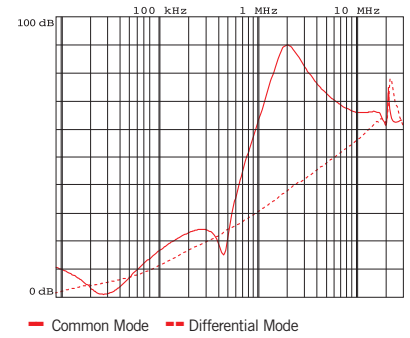

### MECHANICAL DIMENSIONS mm

FIN35	A	B	V	F	H	I	L	N	d	Weight Kg.	Case
.005.F	29	51	13.5	4.5	84.5	63.5	74.5	-	6.5	0.13	1
.010.F	33	51	13.5	4.5	84.5	63.5	74.5	-	6.5	0.18	2
.016.F	39.5	51	13.5	4.5	97	75.5	86.5	-	6.5	0.26	3
.024.M	49.5	51	13	4.5	70	93	51	60	-	0.46	4

#### CASE 1, 2, 3

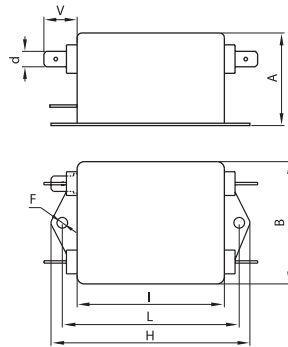

#### ASSEMBLY CONNECTION "F"

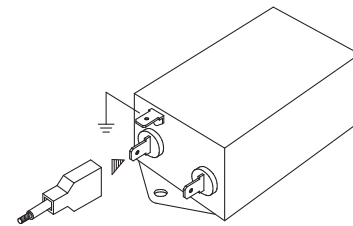

#### CASE 4

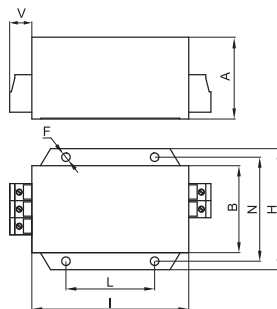

#### ASSEMBLY CONNECTION "M"

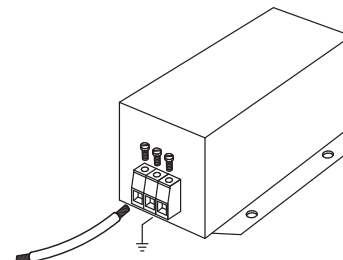



## EMI/RFI Filter with very high attenuation for industrial applications

Datasheet 3/2019

### APPROVALS:



**FIN40.(005 - 016).F**

### FEATURES

- Rated current from 5 to 24A
- Low leakage current
- Faston connections
- Panel mounting

### BENEFITS

- 5 Year warranty
- Very high differential and common mode attenuation
- Compact design
- Suitable for medical applications

### MARKETS

- Conveyors
- CNC machinery
- Variable frequency drives / servo drives
- Medical equipment

### ORDERING CODE

FIN40	.016	.F
Model	Current (A)	Connection
		F = Faston
		M = Terminal block



**FIN40.024.M**

### ATTENUATION INDICATOR

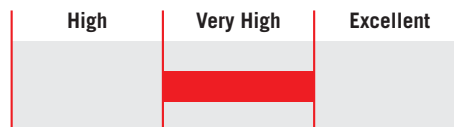

### ELECTRIC DIAGRAM

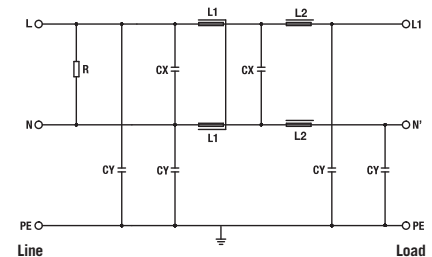

### TECHNICAL SPECIFICATIONS

Nominal voltage	0 / 250 Vac
Frequency	50 – 60 Hz
Rated current	5 to 24A
Potential test voltage phase to phase	1750 Vdc (2 sec.)
Potential test voltage phase to ground	2150 Vdc (2 sec.)
Leakage current normal conditions	< 1.5 mA *
Leakage current worst conditions	< 5 mA
IP Protection	IP20
Overload capability	4 x Rated current (Switch ON) 2 x In 10 seconds 1.5 In for 10 minutes
Climatic class	-40 / +85° C
MTBF at 40°C	250.000 Hrs

\* Voltage 230 Vac phase to ground 50 Hz / 40°C

### ELECTRICAL CHARACTERISTICS

FIN40	Rated Current 40°C	Rated Current 50°C	Power Loss (W)
.005.F	5	3	2
.010.F	10	7	2.7
.016.F	16	12	5
.024.M	24	20	6

### CONNECTIONS

LINE			PE
Solid Cable (mm <sup>2</sup> )	Stranded Cable (mm <sup>2</sup> )	Terminal Block Torque (Nm)	Torque (Nm)
0.2 - 6	0.5 - 4	-	-
0.2 - 6	0.5 - 4	-	-
0.2 - 6	0.5 - 4	-	-
0.2 - 6	0.5 - 4	0.8	0.8

### TYPICAL ATTENUATION

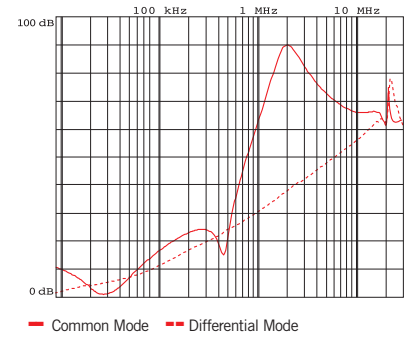

### MECHANICAL DIMENSIONS mm

FIN40	A	B	V	F	H	I	L	N	d	Weight Kg.	Case
.005.F	29	51	13.5	4.5	84.5	63.5	74.5	-	6.5	0.13	1
.010.F	33	51	13.5	4.5	84.5	63.5	74.5	-	6.5	0.18	2
.016.F	39.5	51	13.5	4.5	97	75.5	86.5	-	6.5	0.26	3
.024.M	49.5	51	13	4.5	70	93	51	60	-	0.46	4

### CASE 1, 2, 3

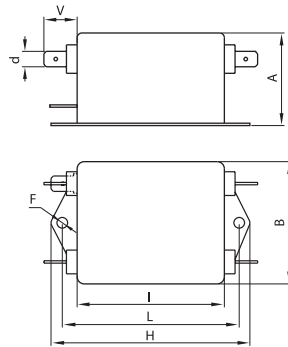

### ASSEMBLY CONNECTION "F"

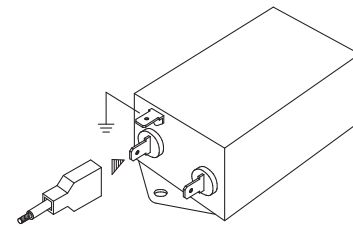

### CASE 4

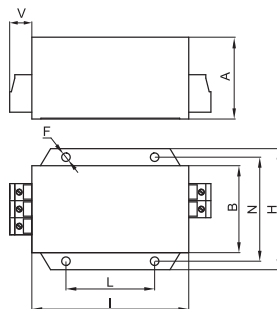

### ASSEMBLY CONNECTION "M"

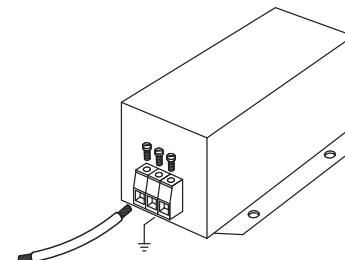



## EMI/RFI Filter with excellent attenuation for industrial applications

Datasheet 3/2019

**APPROVALS:**

**FIN50.(005 - 016).F**
**FEATURES**

- Rated current from 5 to 24A
- Low leakage current
- Panel mounting

**BENEFITS**

- 5 Year warranty
- High differential and common mode attenuation
- High performance

**MARKETS**

- Packaging machinery
- Renewable energy
- CNC machinery
- Printing machinery

**ORDERING CODE**

FIN50	.016	.F
Model	Current (A)	Connection
		F = Faston
		M = Terminal block

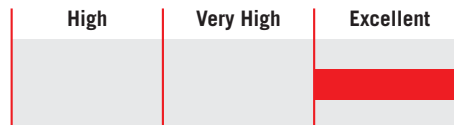
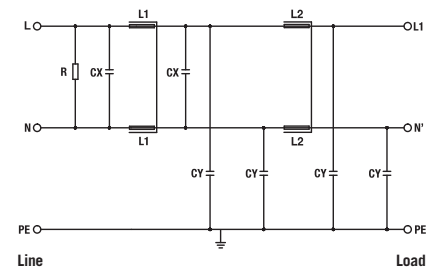
**FIN50.024.M**
**ATTENUATION INDICATOR**

**ELECTRIC DIAGRAM**

**TECHNICAL SPECIFICATIONS**

Nominal voltage	0 / 250 Vac
Frequency	50 – 60 Hz
Rated current	5 to 24A
Potential test voltage phase to phase	1750 Vdc (2 sec.)
Potential test voltage phase to ground	2150 Vdc (2 sec.)
Leakage current normal conditions	< 2.2 mA *
Leakage current worst conditions	< 7 mA
IP Protection	IPO0 up to 16A – over IP20
Overload capability	4 x Rated current (Switch ON) 2 x In 10 seconds 1.5 In for 10 minutes
Climatic class	-40 / +85° C
MTBF at 40°C	250.000 Hrs

\* Voltage 230 Vac phase to ground 50 Hz / 40°C



### ELECTRICAL CHARACTERISTICS

FIN50	Rated Current 40°C	Rated Current 50°C	Power Loss (W)
.005.F	5	3	2
.010.F	10	7	2.7
.016.F	16	12	5
.024.M	24	20	6

### CONNECTIONS

LINE			PE
Solid Cable (mm <sup>2</sup> )	Stranded Cable (mm <sup>2</sup> )	Terminal Block Torque (Nm)	Torque (Nm)
0.2 - 6	0.5 - 4	-	-
0.2 - 6	0.5 - 4	-	-
0.2 - 6	0.5 - 4	-	-
0.2 - 6	0.5 - 4	0.8	0.8

### TYPICAL ATTENUATION

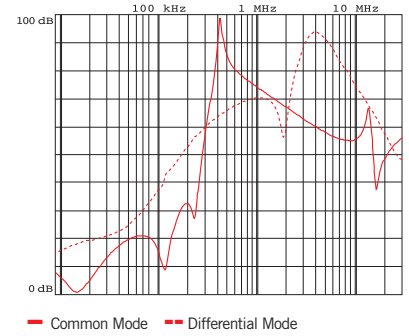

### MECHANICAL DIMENSIONS mm

FIN50	A	B	V	F	H	I	L	N	d	Weight Kg.	Case
.005.F	39	51	13.5	4.5	84.5	63.5	74.5	-	6.5	0.20	1
.010.F	49.5	51	13.5	4.5	97	75.5	86.5	-	6.5	0.35	2
.016.F	45	84.5	13.5	4.5	105	99.5	51	95	6.5	0.70	3
.024.M	49.5	84.5	13	4.5	105	99.5	51	95	-	0.93	4

#### CASE 1, 2

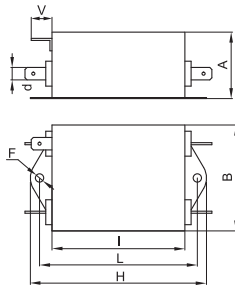

#### ASSEMBLY CONNECTION "F"

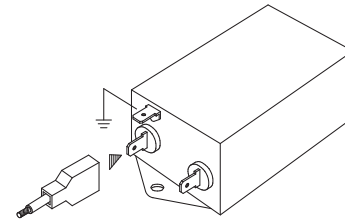

#### CASE 3

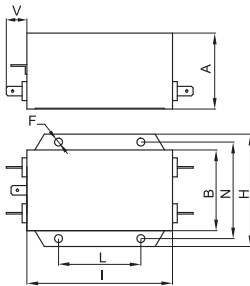

#### ASSEMBLY CONNECTION "F"

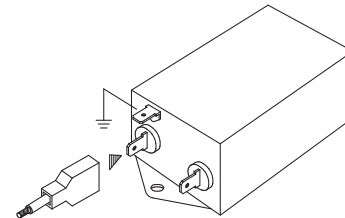

#### CASE 4

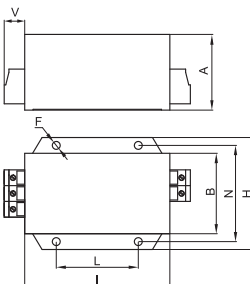

#### ASSEMBLY CONNECTION "M"

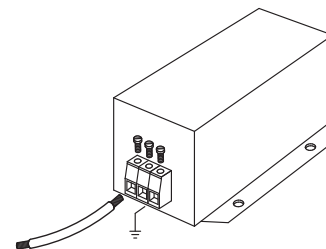



## EMI/RFI Filter with excellent attenuation for industrial applications

Datasheet 3/2019

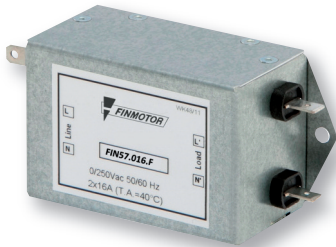
**APPROVALS:**

**FIN57.(006 – 016).F**
**FEATURES**

- Rated current from 6 to 25A
- Low leakage current
- Excellent performance

**BENEFITS**

- 5 Year warranty
- Excellent differential and common mode attenuation
- Compact design

**MARKETS**

- Packaging machinery
- Renewable energy
- CNC machinery
- Printing machinery

**ORDERING CODE**

FIN57	.016	.F
Model	Current (A)	Connection
		F = Faston
		V = Screw

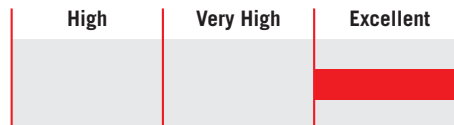
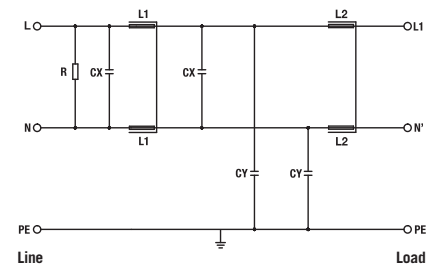
**FIN57.025.V**
**ATTENUATION INDICATOR**

**ELECTRIC DIAGRAM**

**TECHNICAL SPECIFICATIONS**

Nominal voltage	0 / 250 Vac
Frequency	50 – 60 Hz
Rated current	6 to 25A
Potential test voltage phase to phase	1750 Vdc (2 sec.)
Potential test voltage phase to ground	2150 Vdc (2 sec.)
Leakage current normal conditions	< 2.2 mA *
Leakage current worst conditions	< 7 mA
IP Protection	IPO0
Overload capability	4 x Rated current (Switch ON) 2 x In 10 seconds 1.5 In for 10 minutes
Climatic class	-40 / +85° C
MTBF at 40°C	250.000 Hrs

\* Voltage 230 Vac phase to ground 50 Hz / 40°C

### ELECTRICAL CHARACTERISTICS

FIN57	Rated Current 40°C	Rated Current 50°C	Power Loss (W)
.006.F	6	4	2
.010.F	10	7	2.7
.016.F	16	12	5
.025.V	25	20	6

### CONNECTIONS

LINE			PE	
Solid Cable (mm <sup>2</sup> )	Stranded Cable (mm <sup>2</sup> )	Terminal Torque (Nm)	d1 (mm)	Torque (Nm)
0.2 - 6	0.5 - 4	-	-	-
0.2 - 6	0.5 - 4	-	-	-
0.2 - 6	0.5 - 4	-	-	-
-	-	-	M4	3

### TYPICAL ATTENUATION

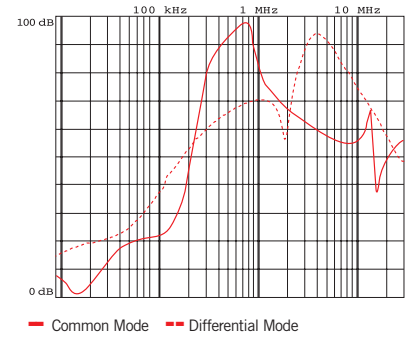

### MECHANICAL DIMENSIONS mm

FIN57	A	B	C	D	E	F	G	V	d	d1	Weight Kg.	Case
.006.F	93	57	45	113	103	4.75	-	12.7	6.3	-	0.45	1
.010.F	93	57	45	113	103	4.75	-	12.7	6.3	-	0.47	1
.016.F	98.5	85.5	57.6	119	109	4.4	51	12.7	6.3	-	0.59	2
.025.V	130.5	56	45	156	143	6	-	15	M4	M4	0.61	3

#### CASE 1

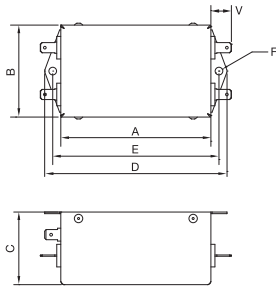

#### ASSEMBLY CONNECTION "F"

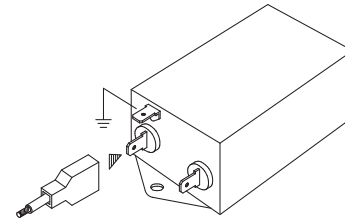

#### CASE 2

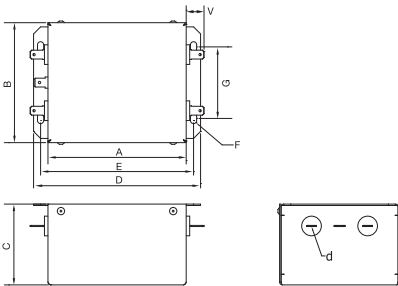

#### ASSEMBLY CONNECTION "F"

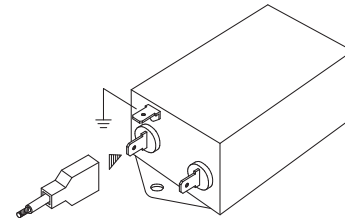

#### CASE 3

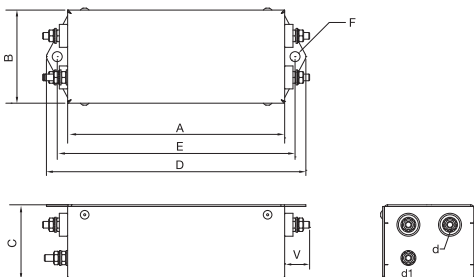

#### ASSEMBLY CONNECTION "V"

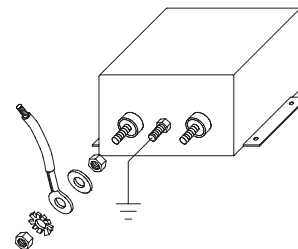



### EMI/RFI Filter with high attenuation for industrial and residential applications

Datasheet 3/2019

#### APPROVALS:



#### FIN60.(001 – 006).VF

#### FEATURES

- Rated current from 1 to 6A
- Very low leakage current
- Compact design

#### BENEFITS

- 5 Year warranty
- High differential and common mode attenuation
- Easy installation
- Suitable for medical applications

#### MARKETS

- Instrumentation
- Vending machinery
- Printing machinery
- Medical equipment

#### ORDERING CODE

FIN60 .006 .VF  
 Model Current (A) Connection  
 VF = Faston

#### ATTENUATION INDICATOR

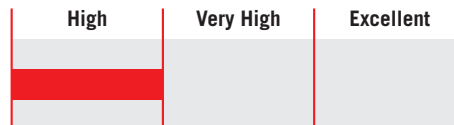

#### ELECTRIC DIAGRAM

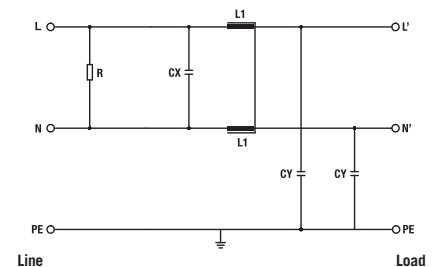

#### TECHNICAL SPECIFICATIONS

Nominal voltage	0 / 250 Vac
Frequency	50 – 60 Hz
Rated current	1 to 6A
Potential test voltage phase to phase	1450 Vdc (2 sec.)
Potential test voltage phase to ground	2150 Vdc (2 sec.)
Leakage current normal conditions	< 1 mA *
Leakage current worst conditions	< 3 mA
IP Protection	IPO0
Overload capability	4 x Rated current (Switch ON) 2 x In 10 seconds 1.5 In for 10 minutes
Climatic class	-40 / +85° C
MTBF at 40°C	250.000 Hrs

\* Voltage 230 Vac phase to ground 50 Hz / 40°C

### ELECTRICAL CHARACTERISTICS

FIN60	Rated Current 40°C	Rated Current 50°C	Power Loss (W)
.001.VF	1	0.7	1
.003.VF	3	2.4	2
.006.VF	6	4	3

### CONNECTIONS

LINE			PE
Solid Cable (mm <sup>2</sup> )	Stranded Cable (mm <sup>2</sup> )	Terminal Block Torque (Nm)	Torque (Nm)
0.2 - 6	0.5 - 4	-	-
0.2 - 6	0.5 - 4	-	-
0.2 - 6	0.5 - 4	-	-

### TYPICAL ATTENUATION

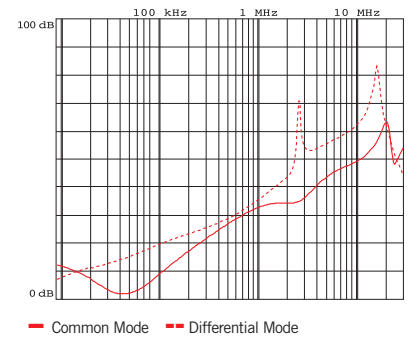

### MECHANICAL DIMENSIONS mm

FIN60	A	B	V	F	H	I	L	C	E	G	d	Weight Kg.	Case
.001.VF	40	22	14	3.5	40	31	23	7	24	50	6.5	0.10	1
.003.VF	40	22	14	3.5	40	31	23	7	24	50	6.5	0.10	1
.006.VF	40	22	14	3.5	40	31	23	7	24	50	6.5	0.11	1

### CASE 1

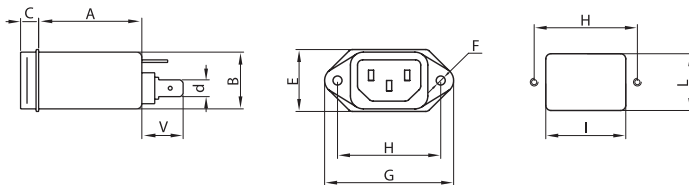

### ASSEMBLY CONNECTION "VF"

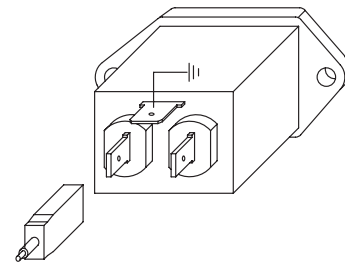





### EMI/RFI Filter with high attenuation for industrial and residential applications

Datasheet 3/2019

#### APPROVALS:



**FIN70.(001 – 006).VF**

#### FEATURES

- Rated current from 1 to 6A
- Very low leakage current
- Fuse integrated

#### BENEFITS

- 5 Year warranty
- High differential and common mode attenuation
- Compact design
- Suitable for medical applications

#### MARKETS

- Instrument and testing machinery
- Vending machinery
- Printing machinery
- Medical equipment

#### ORDERING CODE

FIN70 .006 .VF  
 Model Current (A) Connection  
 VF = Faston

#### ATTENUATION INDICATOR

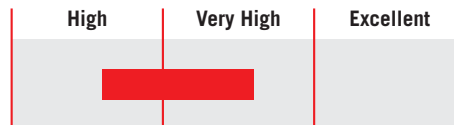

#### ELECTRIC DIAGRAM

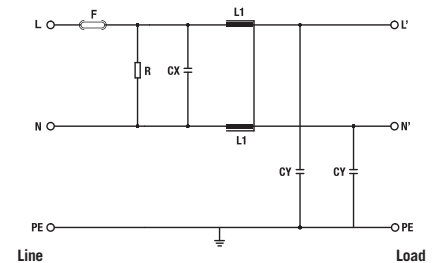

#### TECHNICAL SPECIFICATIONS

Nominal voltage	0 / 250 Vac
Frequency	50 – 60 Hz
Rated current	1 to 6A
Potential test voltage phase to phase	1450 Vdc (2 sec.)
Potential test voltage phase to ground	2150 Vdc (2 sec.)
Leakage current normal conditions	< 1 mA *
Leakage current worst conditions	< 3 mA
IP Protection	IPO0
Overload capability	4 x Rated current (Switch ON) 2 x In 10 seconds 1.5 In for 10 minutes
Climatic class	-40 / +85° C
MTBF at 40°C	250.000 Hrs

\* Voltage 230 Vac phase to ground 50 Hz / 40°C

### ELECTRICAL CHARACTERISTICS

FIN70	Rated Current 40°C	Rated Current 50°C	Power Loss (W)
.001.VF	1	0.7	1
.003.VF	3	2.4	2
.006.VF	6	4	3

### CONNECTIONS

LINE			PE
Solid Cable (mm <sup>2</sup> )	Stranded Cable (mm <sup>2</sup> )	Terminal Block Torque (Nm)	Torque (Nm)
0.2 - 6	0.5 - 4	-	-
0.2 - 6	0.5 - 4	-	-
0.2 - 6	0.5 - 4	-	-

### TYPICAL ATTENUATION

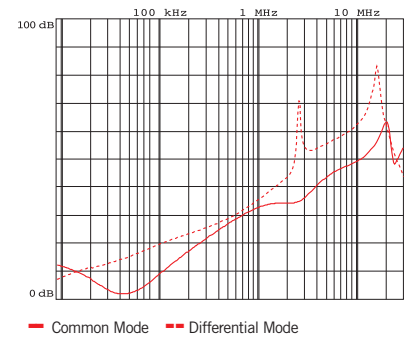

### MECHANICAL DIMENSIONS mm

FIN70	A	B	V	F	H	I	L	C	E	G	d	Weight Kg.	Case
.001.VF	40	33	14	3.5	36	29.5	33.5	7	36	45	6.5	0.12	1
.003.VF	40	33	14	3.5	36	29.5	33.5	7	36	45	6.5	0.12	1
.006.VF	40	33	14	3.5	36	29.5	33.5	7	36	45	6.5	0.12	1

### CASE 1

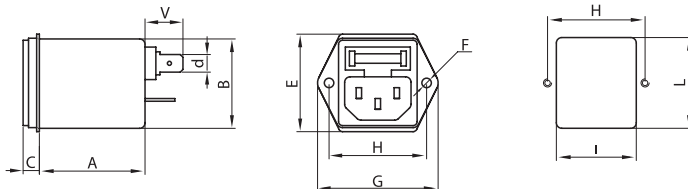

### ASSEMBLY CONNECTION "VF"

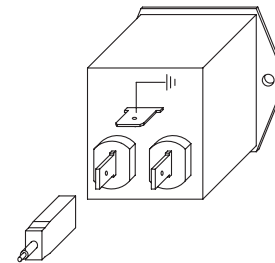



## EMI/RFI Filter with very high attenuation for industrial and residential applications

Datasheet 3/2019

### APPROVALS:



**FIN80.(001 – 010).VFI**

### FEATURES

- Rated current from 1 to 10A
- Very low leakage current
- Integrated fuse and power switch

### BENEFITS

- 5 Year warranty
- Very high differential and common mode attenuation
- Compact design
- Suitable for medical applications

### MARKETS

- Instrument and testing machinery
- Vending machinery
- Printing machinery
- Medical equipment

### ORDERING CODE

FIN80	.006	VFI
Model	Current (A)	Connection
		VFI = Faston with switch

### ATTENUATION INDICATOR

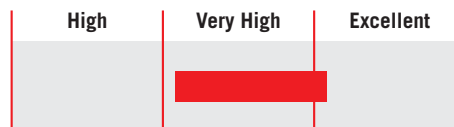

### ELECTRIC DIAGRAM

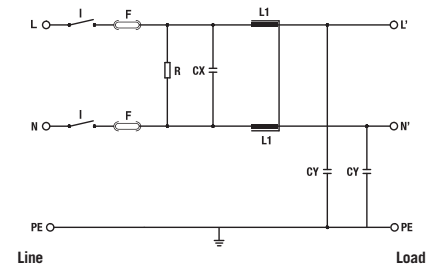

### TECHNICAL SPECIFICATIONS

Nominal voltage	0 / 250 Vac
Frequency	50 – 60 Hz
Rated current	1 to 10A
Potential test voltage phase to phase	1450 Vdc (2 sec.)
Potential test voltage phase to ground	2150 Vdc (2 sec.)
Leakage current normal conditions	< 1 mA *
Leakage current worst conditions	< 3 mA
IP Protection	IPO0
Overload capability	4 x Rated current (Switch ON) 2 x In 10 seconds 1.5 In for 10 minutes
Climatic class	-40 / +85° C
MTBF at 40°C	250.000 Hrs

\* Voltage 230 Vac phase to ground 50 Hz / 40°C

### ELECTRICAL CHARACTERISTICS

FIN80	Rated Current 40°C	Rated Current 50°C	Power Loss (W)
.001.VFI	1	0.7	1
.003.VFI	3	2.5	2
.006.VFI	6	4	3
.010.VFI	10	8	5

### CONNECTIONS

LINE			PE
Solid Cable (mm <sup>2</sup> )	Stranded Cable (mm <sup>2</sup> )	Terminal Block Torque (Nm)	Torque (Nm)
02. - 6	02. - 6	-	-
02. - 6	02. - 6	-	-
02. - 6	02. - 6	-	-
02. - 6	02. - 6	-	-

### TYPICAL ATTENUATION

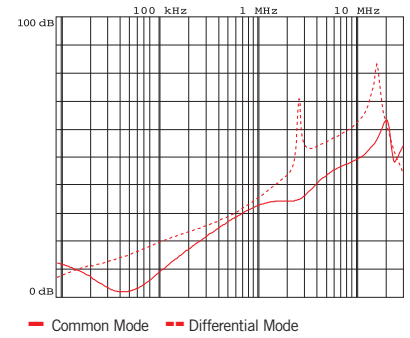

### MECHANICAL DIMENSIONS mm



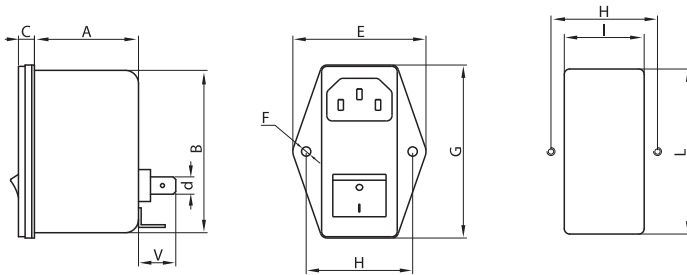

FIN80	A	B	V	F	H	I	L	C	E	G	d	Weight Kg.	Case
.001.VFI	39	61	14	3.5	40	30	62	6	50	65	6.5	0.20	1
.003.VFI	39	61	14	3.5	40	30	62	6	50	65	6.5	0.20	1
.006.VFI	39	61	14	3.5	40	30	62	6	50	65	6.5	0.21	1
.010.VFI	39	61	14	3.5	40	30	62	6	50	65	6.5	0.22	1

### CASE 1

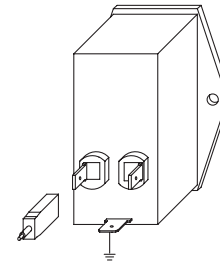

### ASSEMBLY CONNECTION "VFI"



Filter Selection Guide	Description	Voltage	CONNECTORS					FEATURES					APPLICATIONS					Approval			
			Faston	Terminal Blocks	Screws	Bus Bar	Cables	IEC Connector/ Faston	DIN Rail Mount	Long Cable Applications	High Att. Low Frequency	Book Case Style	Low Leakage Current	Multiple Drives	Automation	Renewable Energy	Commercial Building		Recharging Station		
<b>Parallel Filters</b>																					
<b>FIN130SP</b>	3-phase	0-600		X					X	X	X				X		X				
<b>FIN230SP</b>	3-phase	0-600		X					X	X	X			X	X	X					
<b>FIN730</b>	3-phase	0-750		X					X		X			X	X	X		X			
<b>FIN735</b>	3-phase	0-650		X					X								X				
<b>FIN740</b>	3-phase plus neutral	0-600		X					X	X	X			X	X	X		X			



Enerdoor parallel filters provide protection from variable frequency drives, SCRs, controllers, and other high commutation electrical equipment. This line provides high attenuation in the frequency range of 10 kHz to 5 MHz offering a solution for applications with low to medium frequency concerns. When used in conjunction with other Enerdoor filters, this combination ensures EMI/RFI protection for equipment in any environment.

This series offers a unique solution available with nominal voltage up to 750 Vac and any current level due to the parallel connection to the line. Offered in 3 phase and 3 phase plus neutral, this line carries CE and UL approvals.

The FIN730 and FIN740 filters reduce EMI interference in the 30 kHz to 10 MHz frequency range. The FIN230 filter has a resonance frequency of 150 kHz and provides a significant interference reduction in the frequency range of 50 kHz to 5 MHz. This series features panel and DIN rail mounting for fast and easy installation.

**Parallel filter applications include:**

- CNC machinery
- Recharging stations
- Multiple drive applications
- Renewable energy
- SCR applications

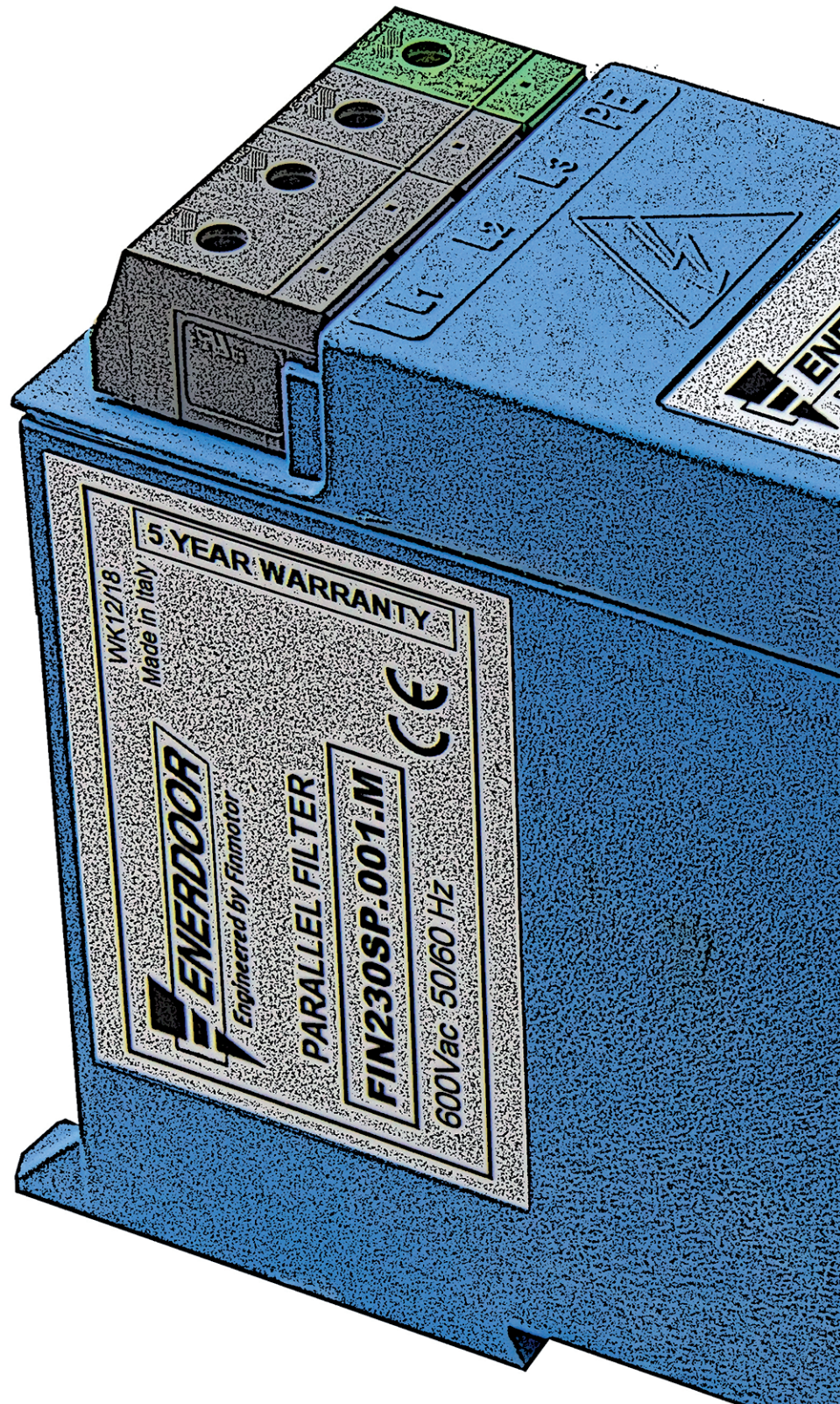



## EMI/RFI Parallel filter with excellent attenuation in low frequency range

Datasheet 3/2019

### APPROVALS:



UL1283  
CSA C22.2

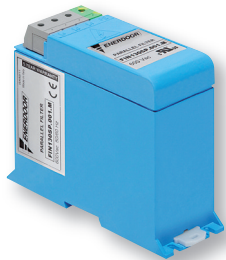

**FIN130SP.001.M**



**FIN230SP.001.M**



**FIN735.001.M**

### FEATURES

- Independent from nominal current
- Low leakage current
- DIN rail or panel mounting
- Excellent attenuation in low frequency range

### BENEFITS

- 5 Year warranty
- High differential and common mode attenuation
- Compact design
- Easy installation

### MARKETS

- CNC machinery
- Recharging stations
- Multiple drive applications
- Renewable energy

### ORDERING CODE

FIN 230SP .001 .M  
Model Connection  
M = Terminal Blocks

### ATTENUATION INDICATOR

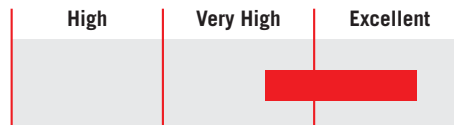

### ELECTRIC DIAGRAM

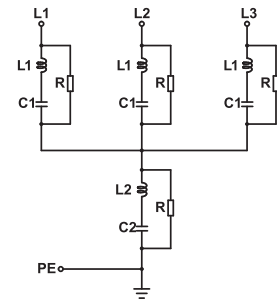

### TECHNICAL SPECIFICATIONS

Nominal voltage	See Electrical Characteristics
Frequency	50 – 60 Hz
Rated current	Unlimited
Potential test voltage phase to phase	2400 Vdc (2 sec.)
Potential test voltage phase to ground	3200 Vdc (2 sec.)
Leakage current normal conditions	< 25 mA *
Leakage current worst conditions	< 70 mA
IP Protection	IP20
Climatic class	-40 / +85° C
MTBF at 40°C	250.000 Hrs

\* Voltage 230 Vac phase to ground 50H / 40°C



### ELECTRICAL CHARACTERISTICS

Model	Nominal Voltage AC (Vac)	Nominal Voltage DC (Vdc)	Power Loss (W)
FIN130SP.001.M	600	1000	10
FIN230SP.001.M	600	1000	10
FIN735.001.M	650	1100	10

### CONNECTIONS

LINE			PE
Solid Cable (mm <sup>2</sup> )	Stranded Cable (mm <sup>2</sup> )	Terminal Block Torque (Nm)	Torque (Nm)
1 - 4	1 - 4	1.8	1.8
1 - 4	1 - 4	1.8	1.8
1 - 4	1 - 4	1.8	1.8

### TYPICAL ATTENUATION

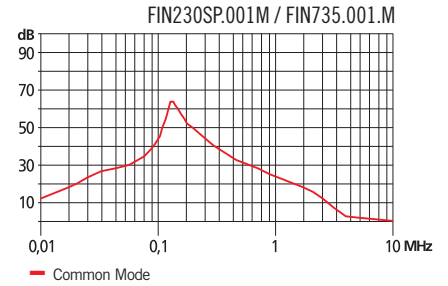
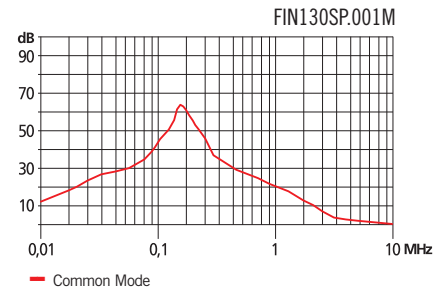

### MECHANICAL DIMENSIONS mm

Model	L	d	E	I	P	A	C	T	G	F	H	Weight Kg.	Case
FIN130SP.001.M	59	4.5	10	35	130	112	166	4	37.5	7	146	1.15	1
FIN230SP.001.M	59	4.5	10	35	130	112	166	4	37.5	7	146	1.15	1
FIN735.001.M	59	4.5	10	35	130	112	166	4	37.5	7	146	1.15	1

### CASE 1

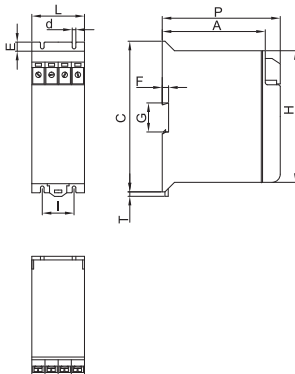

### ASSEMBLY CONNECTION "M"

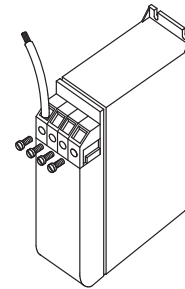



Datasheet 3/2019

### EMI/RFI Parallel filter with excellent attenuation in low frequency range

#### APPROVALS:



UL1283  
CSA C22.2



**FIN730.001.M (C - LCP)**

#### FEATURES

- Independent from nominal current
- Low leakage current
- DIN rail or panel mounting
- Excellent attenuation in low frequency range

#### BENEFITS

- 5 Year warranty
- High differential and common mode attenuation
- Compact design
- Easy installation

#### MARKETS

- CNC machinery
- Recharging stations
- Multiple drive applications
- Renewable energy

#### ORDERING CODE

FIN 730.001. .M  
Model Nominal voltage  
M = 750Vac  
MC = 600Vac  
MLCP = 480Vac

#### ATTENUATION INDICATOR



#### ELECTRIC DIAGRAM

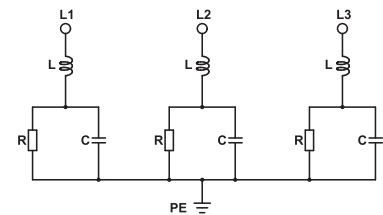

#### TECHNICAL SPECIFICATIONS

Nominal voltage	See Electrical Characteristics
Frequency	50 – 60 Hz
Rated current	Unlimited
Potential test voltage phase to phase	2400 Vdc (2 sec.)
Potential test voltage phase to ground	3200 Vdc (2 sec.)
Leakage current normal conditions	< 25 mA *
Leakage current worst conditions	< 70 mA
IP Protection	IP20
Climatic class	-40 / +85° C
MTBF at 40°C	250.000 Hrs

\* Voltage 230 Vac phase to ground 50 Hz / 40°C

### ELECTRICAL CHARACTERISTICS

Model	Nominal Voltage AC (Vac)	Nominal Voltage DC (Vdc)	Power Loss (W)
FIN730.001.M	750	1200	10
FIN730.002.MC	600	1000	10
FIN730.001.MLCP	480	800	10

### CONNECTIONS

Solid Cable (mm <sup>2</sup> )	Stranded Cable (mm <sup>2</sup> )	Terminal Block Torque (Nm)	PE
			Torque (Nm)
1 - 4	1 - 4	1.8	1.8
1 - 4	1 - 4	1.8	1.8
1 - 4	1 - 4	1.8	1.8

### TYPICAL ATTENUATION



### MECHANICAL DIMENSIONS mm

Model	L	d	E	I	P	A	C	T	G	F	H	Weight Kg.	Case
FIN730.001.M	59	4.5	10	35	130	112	166	4	37.5	7	146	1.15	1
FIN730.002.MC	59	4.5	10	35	130	112	166	4	37.5	7	146	1.15	1
FIN730.001.MLCP	59	4.5	10	35	130	112	166	4	37.5	7	146	1.15	1

### CASE 1

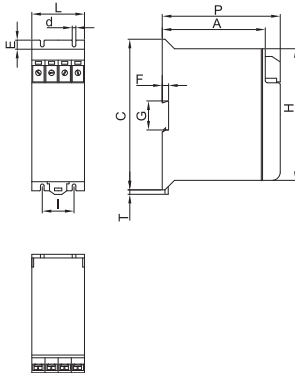

### ASSEMBLY CONNECTION "M"

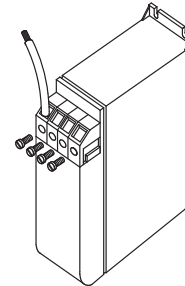



### EMI/RFI Parallel filter with excellent attenuation in low frequency range

Datasheet 3/2019

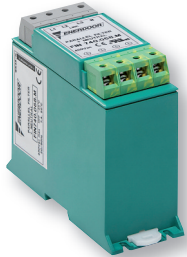

**FIN740.068.M**

#### APPROVALS:



UL1283  
CSA C22.2



#### FEATURES

- Independent from nominal current
- Low leakage current
- DIN rail or panel mounting
- Excellent attenuation in low frequency range

#### BENEFITS

- 5 Year warranty
- High differential and common mode attenuation
- Compact design
- 3-phase plus neutral application

#### MARKETS

- CNC machinery
- Recharging stations
- Multiple drive applications
- Renewable energy

#### ORDERING CODE

FIN740 .068 .M  
Model Connection  
M = Terminal block

#### ATTENUATION INDICATOR

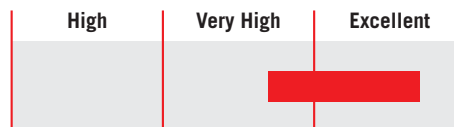

#### ELECTRIC DIAGRAM

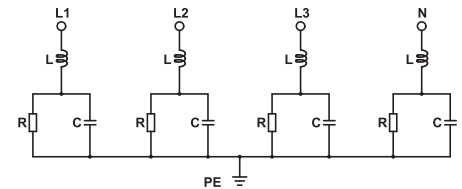

#### TECHNICAL SPECIFICATIONS

Nominal voltage	0 / 600 Vac
Frequency	50 – 60 Hz
Rated current	Unlimited
Potential test voltage phase to phase	2200 Vdc (2 sec.)
Potential test voltage phase to ground	2900 Vdc (2 sec.)
Leakage current normal conditions	<20 mA*
Leakage current worst conditions	<60 mA
IP Protection	IP20
Climatic class	-40 / +85° C
MTBF at 40°C	250.000 Hrs

\* Voltage 230 Vac phase to ground 50 Hz / 40°C

### ELECTRICAL CHARACTERISTICS

Model	Nominal Voltage AC (Vac)	Nominal Voltage DC (Vdc)	Power Loss (W)
FIN740.068.M	480	800	10

### CONNECTIONS

LINE			PE
Solid Cable (mm <sup>2</sup> )	Stranded Cable (mm <sup>2</sup> )	Terminal Block Torque (Nm)	Torque (Nm)
1 - 4	1 - 4	1.8	1.8

### TYPICAL ATTENUATION

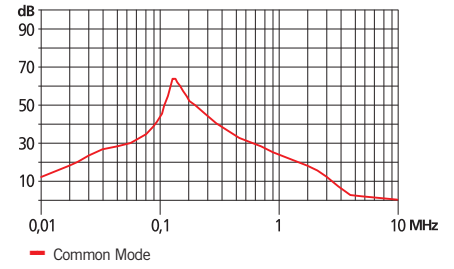

### MECHANICAL DIMENSIONS mm

Model	L	d	E	I	P	A	C	T	G	F	H	Weight Kg.	Case
FIN740.068.M	59	4.5	10	35	130	112	166	4	37.5	7	146	1.15	1

### CASE 1

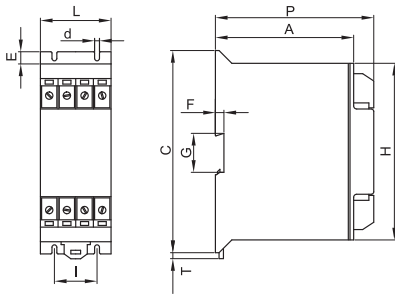

### ASSEMBLY CONNECTION "M"

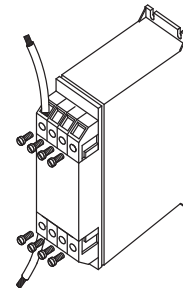



Filter Selection Guide	Description	Current Range (A)	Voltage	CONNECTORS			FEATURES						APPLICATIONS				
				Terminal Blocks	Screws	Bus Bar	Regenerative Systems	DIN Rail Mount	Long Cable Applications	Low Frequency Attenuation	Book Case Style	Very Low Leakage Current	Machine Tools	Automation	Renewable Energy	IT Network	Medical
<b>Three Phase</b>																	
FIN1351	3-phase	6-16	0-480	X				X				X		X			X
FIN538	3-phase	5-30	0-480	X				X						X			
FIN538S	3-phase	7-180	0-600	X	X	X			X					X	X		UL US
FIN538S1	3-phase	7-3000	0-600	X	X	X	X		X		X		X	X	X		UL US
FIN539S	3-phase	400-2500	0-600			X	X		X		X						
FIN1200	3-phase	5-3000	0-480		X	X						X		X			X UL US
FIN1200HV	3-phase	5-3000	0-600		X	X						X					X UL US
FIN1500	3-phase	5-3000	0-480		X	X	X		X	X			X		X		UL US
FIN1500HV	3-phase	5-3000	0-600		X	X	X		X	X			X		X		UL US
FIN1600	3-phase	7-200	0-480	X					X		X						
FIN1700	3-phase	6-200	0-600	X								X	X		X		X UL US
FIN1700G	3-phase	6-200	0-600	X					X		X	X		X			X UL US
FIN1700E	3-phase	7-230	0-500	X							X	X		X			X UL US
FIN1700EG	3-phase	7-230	0-500	X							X	X		X			X UL US
FIN1700IT	3-phase	6-200	0-600	X	X	X					X					X	
FIN1900	3-phase	6-200	0-600	X			X				X		X	X	X		UL US
FIN1900G	3-phase	6-200	0-600	X			X		X		X		X	X	X		UL US
FIN1900E	3-phase	6-230	0-500	X							X		X	X	X		UL US
FIN1900EG	3-phase	6-230	0-500	X					X		X		X	X	X		UL US
FIN1900S	3-phase	42-200	0-600	X			X		X	X	X		X	X	X		UL US
FIN3755	3-phase	7-280	0-480	X							X			X			UL US
FIN7213	3-phase	150-3000	0-480			X	X		X	X				X	X		

Enerdoor three phase filters provide high attenuation in a compact case with low leakage current and are suitable for a large range of industries. Enerdoor offers solutions in traditional TN and TNS networks and in specific applications such as IT power line configurations.

This line carries CE, UL and CSA approvals and offers a current range from 5 to 3000A with nominal voltage up to 750 Vac.

This series features easy installation and is available with DIN rail mounting, bus bar connectors, safety terminal blocks and finger safe protection. Customized solutions are available to satisfy various application requirements.

### Three phase applications include:

- Automated machinery
- Packaging machinery
- Variable frequency drives
- Servo drives
- IT networks
- Medical equipment
- CNC machinery
- HVAC systems
- Recharging stations
- Renewable energy
- Uninterruptible power supplies

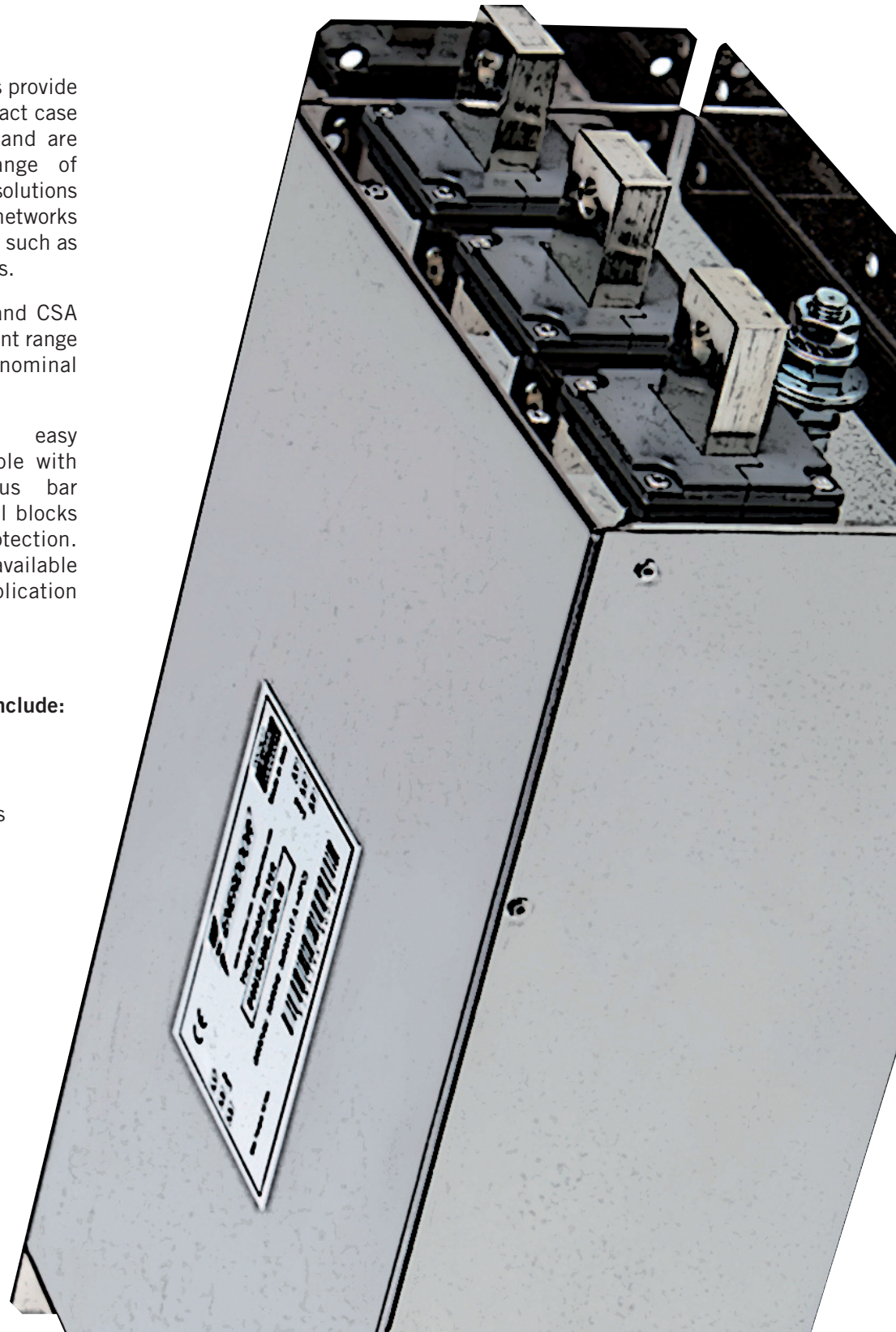



### EMI/RFI filter with high attenuation for industrial and residential applications

Datasheet 3/2019

#### APPROVALS:



**FIN1351.(006 - 016).M**

#### FEATURES

- Rated current from 6 to 16A
- Very low leakage current
- DIN rail mounting

#### BENEFITS

- 5 Year warranty
- Suitable for medical applications
- Very compact design
- Protects equipment

#### MARKETS

- Conveyors
- Testing equipment
- High tech machinery
- Automated machinery

#### ORDERING CODE

FIN1351 .016 .M  
 Model Current (A) Connection  
 M = Terminal block

#### ATTENUATION INDICATOR

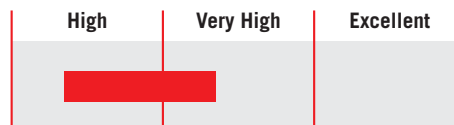

#### ELECTRIC DIAGRAM

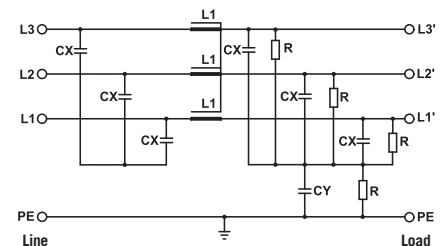

#### TECHNICAL SPECIFICATIONS

Nominal voltage	0 / 480 Vac
Frequency	50 – 60 Hz
Rated current	6 to 16A
Potential test voltage phase to phase	2200 Vdc (2 sec.)
Potential test voltage phase to ground	2900 Vdc (2 sec.)
Leakage current normal conditions	< 3 mA *
Leakage current worst conditions	< 5 mA
IP Protection	IP20
Overload capability	4 x Rated current (Switch ON) 2 x In 10 seconds 1.5 In for 10 minutes
Climatic class	-40 / +85° C
MTBF at 40°C	250.000 Hrs

\* Voltage 230 Vac phase to ground 50 Hz / 40°C

### ELECTRICAL CHARACTERISTICS

FIN1351	Rated Current 40°C	Rated Current 50°C	Power Loss (W)
.006.M	6	5	6
.010.M	10	8	8
.016.M	16	14	10

### CONNECTIONS

LINE			PE
Solid Cable (mm <sup>2</sup> )	Stranded Cable (mm <sup>2</sup> )	Terminal Block Torque (Nm)	Torque (Nm)
0.2 - 6	0.2 - 4	0.8	0.8
0.2 - 6	0.2 - 4	0.8	0.8
0.2 - 6	0.2 - 4	0.8	0.8

### TYPICAL ATTENUATION

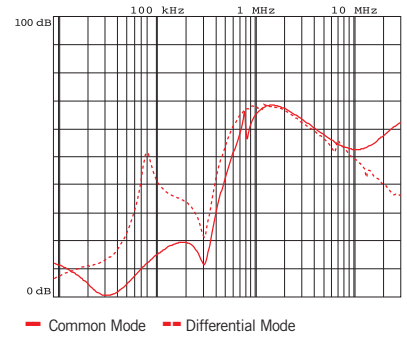

### MECHANICAL DIMENSIONS mm

FIN1351	A	B	H	N	Weight Kg.	Case
.006.M	65	85	39	11	0.32	1
.010.M	65	85	39	11	0.32	1
.016.M	65	85	39	11	0.32	1

### CASE 1

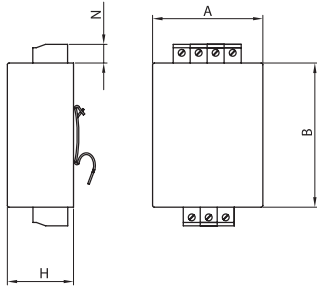

### ASSEMBLY CONNECTION "M"

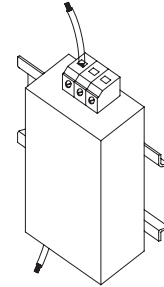



## EMI/RFI Filter with high attenuation for industrial applications

Datasheet 3/2019



**FIN538.(005 - 030).M**

### APPROVALS:



### FEATURES

- Rated current from 5 to 30A
- High differential and common mode attenuation
- Low leakage current
- DIN rail mounting

### BENEFITS

- 5 Year warranty
- Easy installation
- Very compact design
- Helps pass immunity and emission tests for the IEC61000-6-2 and IEC61000-6-4 Standards

### MARKETS

- Conveyors
- Testing equipment
- High tech machinery
- Automated machinery

### ORDERING CODE

FIN538 .016 .M  
 Model Current (A) Connection  
 M = Terminal block

### ATTENUATION INDICATOR

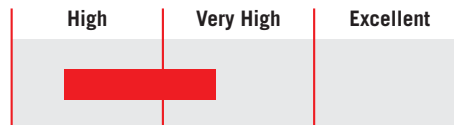

### ELECTRIC DIAGRAM

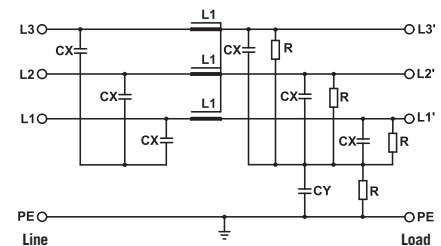

### TECHNICAL SPECIFICATIONS

Nominal voltage	0 / 480 Vac
Frequency	50 – 60 Hz
Rated current	5 to 30A
Potential test voltage phase to phase	2200 Vdc (2 sec.)
Potential test voltage phase to ground	2900 Vdc (2 sec.)
Leakage current normal conditions	< 10 mA *
Leakage current worst conditions	< 80 mA
IP Protection	IP20
Overload capability	4 x Rated current (Switch ON) 2 x In 10 seconds 1.5 In for 10 minutes
Climatic class	-40 / +85° C
MTBF at 40°C	250.000 Hrs

\* Voltage 230 Vac phase to ground 50 Hz / 40°C

### ELECTRICAL CHARACTERISTICS

FIN538	Rated Current 40°C	Rated Current 50°C	Power Loss (W)
.005.M	8	6	8
.010.M	14	12	10
.016.M	18	16	12
.025.M	28	25	15
.030.M	35	32	23

### CONNECTIONS

LINE			PE
Solid Cable (mm <sup>2</sup> )	Stranded Cable (mm <sup>2</sup> )	Terminal Block Torque (Nm)	Torque (Nm)
1 - 4	1 - 4	1.8	1.8
1 - 4	1 - 4	1.8	1.8
1 - 4	1 - 4	1.8	1.8
1 - 4	1 - 4	1.8	1.8
1 - 4	1 - 4	1.8	1.8

### TYPICAL ATTENUATION

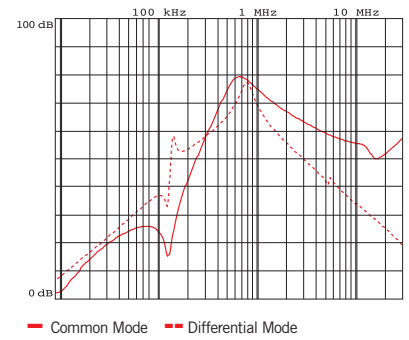

### MECHANICAL DIMENSIONS mm

FIN538	A	E	C	P	F	H	I	L	G	d	T	Weight Kg.	Case
.005.M	112	10	166	130	7	146	35	59	37.5	4.5	4	1.15	1
.010.M	112	10	166	130	7	146	35	59	37.5	4.5	4	1.15	1
.016.M	112	10	166	130	7	146	35	59	37.5	4.5	4	1.15	1
.025.M	112	10	166	130	7	146	35	59	37.5	4.5	4	1.15	1
.030.M	112	10	166	130	7	146	35	59	37.5	4.5	4	1.15	1

### CASE 1

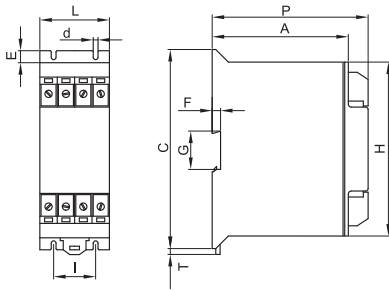

### ASSEMBLY CONNECTION "M"

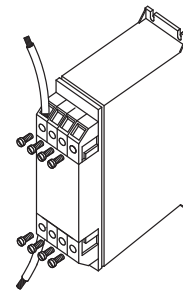



### EMI/RFI Filter with very high attenuation for industrial applications

Datasheet 3/2019

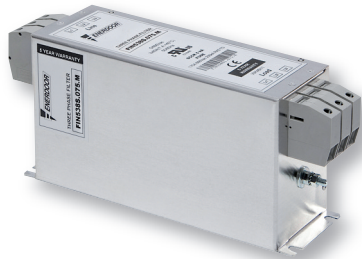

**FIN538S.(007 - 180).M**

#### FEATURES

- Rated current from 7 to 180A
- Very high differential and common mode attenuation
- Low leakage current

#### MARKETS

- Conveyors
- Testing equipment
- High tech machinery
- Automated machinery

#### APPROVALS:



**SCCR** by UL508A

#### BENEFITS

- 5 Year warranty
- Very high attenuation
- Easy installation

#### ORDERING CODE

FIN538S .016 .M  
 Model Current (A) Connection  
 M = Terminal block

#### ATTENUATION INDICATOR

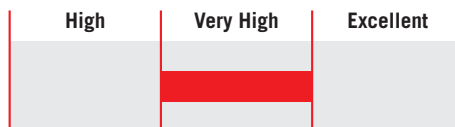

#### ELECTRIC DIAGRAM

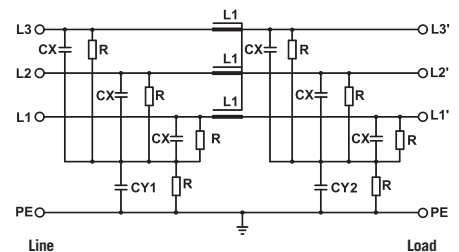

#### TECHNICAL SPECIFICATIONS

Nominal voltage	0 / 600 Vac
Frequency	50 – 60 Hz
Rated current	7 to 180A
Potential test voltage phase to phase	2400 Vdc (2 sec.)
Potential test voltage phase to ground	3200 Vdc (2 sec.)
Leakage current normal conditions	< 10 mA *
Leakage current worst conditions	< 80 mA
IP Protection	IP20
Overload capability	4 x Rated current (Switch ON) 2 x In 10 seconds 1.5 In for 10 minutes
Climatic class	-40 / +85° C
MTBF at 40°C	250.000 Hrs

\* Voltage 230 Vac phase to ground 50 Hz / 40°C



### ELECTRICAL CHARACTERISTICS

FIN538S	Rated Current 40°C	Rated Current 50°C	Power Loss (W)
.007.M	8	7	3
.016.M	18	16	4
.030.M	34	30	10
.042.M	47	42	18
.055.M	60	55	23
.075.M	83	75	37
.100.M	110	100	52
.130.M	142	130	65
.180.M	200	180	77

### CONNECTIONS

LINE			PE	
Solid Cable (mm <sup>2</sup> )	Stranded Cable (mm <sup>2</sup> )	Terminal Torque (Nm)	d (mm)	Torque (Nm)
0.2 - 10	0.2 - 6	1.2	M6	1.2
0.2 - 10	0.2 - 6	1.2	M6	1.2
0.2 - 10	0.2 - 6	1.2	M6	1.2
0.5 - 16	0.5 - 10	1.8	M6	1.8
0.5 - 16	0.5 - 10	1.8	M6	1.8
4 - 25	6 - 35	4.5	M6	4.5
10 - 50	10 - 50	4	M10	4
10 - 50	10 - 50	4	M10	4
35 - 95	35 - 95	20	M10	20

### TYPICAL ATTENUATION

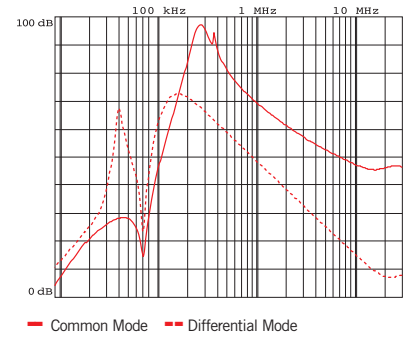

### MECHANICAL DIMENSIONS mm

FIN538S	A	B	V	V1	F	H	I	L	N	d	Weight Kg.	Case
.007.M	100	90	22	16	5.4	250	220	7.5	60	M6	1.3	1
.016.M	100	90	22	16	5.4	250	220	7.5	60	M6	1.3	1
.030.M	100	90	22	16	5.4	250	220	7.5	60	M6	1.3	1
.042.M	100	90	22	35	5.4	250	220	7.5	60	M6	1.5	1
.055.M	100	90	22	35	5.4	250	220	7.5	60	M6	1.7	1
.075.M	135	85	22	39	6.5	270	240	7.5	60	M6	2.2	1
.100.M	155	90	24	43	6.5	270	240	7.5	60	M10	3.2	1
.130.M	155	90	24	43	6.5	270	240	7.5	60	M10	3.2	1
.180.M	170	125	26	51	6.5	380	350	7.5	102	M10	5.1	1

### CASE 1

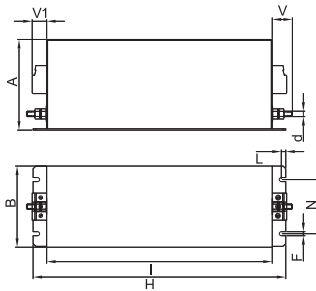

### ASSEMBLY CONNECTION "M"

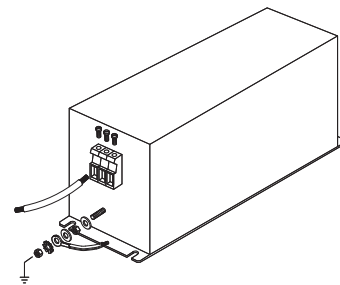



### EMI/RFI Filter with excellent attenuation for industrial applications

Datasheet 3/2019

#### APPROVALS:

UL1283  
CSA C22.2  
E215863

RoHS



SCCR by UL508A

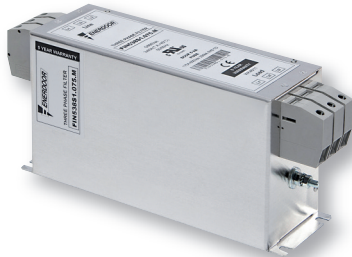

**FIN538S1.(007 - 180).M**



**FIN538S1.(250 - 280).V**

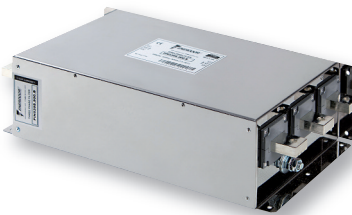

**FIN538S1.(280 - 1750).BC**

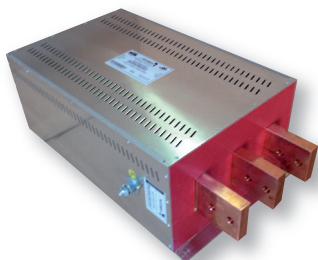

**FIN538S1.(1750 - 3000).BC**

#### FEATURES

- Rated current from 7 to 3000A
- Excellent differential and common mode attenuation
- Low leakage current
- Terminal blocks up to 180A

#### MARKETS

- Electrical equipment
- Machine tools
- Industrial automation
- Frequency drives and servo drives
- Regenerative systems
- Renewable energy

#### BENEFITS

- 5 Year warranty
- Various connections available
- Finger safe protection available
- Vertical bus bar available

#### ORDERING CODE

FIN538S1	.007	.M
Model	Current (A)	Connection
		M = Terminal block
		V = Screw
		BC = Bus bar

#### ATTENUATION INDICATOR



#### ELECTRIC DIAGRAM

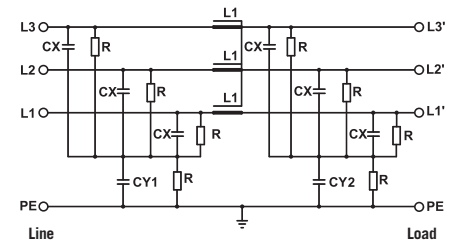

#### TECHNICAL SPECIFICATIONS

Nominal voltage	0 / 600 Vac
Frequency	50 - 60 Hz
Rated current	7 to 3000A
Potential test voltage phase to phase	2400 Vdc (2 sec.)
Potential test voltage phase to ground	3200 Vdc (2 sec.)
Leakage current normal conditions	< 10 mA *
Leakage current worst conditions	< 80 mA
IP Protection	IP20 up to 180A IP00 over 280A (IP 20 available with protection FINPRT)
Overload capability	4 x Rated current (Switch ON) 2 x In 10 seconds 1.5 In for 10 minutes
Climatic class	-40 / +85° C
MTBF at 40°C	250.000 Hrs

\* Voltage 230 Vac phase to ground 50 Hz / 40°C

### ELECTRICAL CHARACTERISTICS

FIN538S1	Rated Current 40°C	Rated Current 50°C	Power Loss (W)
.007.M	8	7	3
.016.M	18	16	4
.030.M	34	30	10
.042.M	47	42	18
.055.M	60	55	23
.075.M	83	75	37
.100.M	110	100	52
.130.M	142	130	65
.180.M	200	180	77

### CONNECTIONS

LINE			PE	
Solid Cable (mm <sup>2</sup> )	Stranded Cable (mm <sup>2</sup> )	Terminal Torque (Nm)	d (mm)	Torque (Nm)
0.2-10	0.2-6	1.2	M10	6
0.2-10	0.2-6	1.2	M10	6
0.2-10	0.2-6	1.2	M10	6
0.5-16	0.5-10	1.8	M10	6
0.5-16	0.5-10	1.8	M10	6
6-35	4-25	4.5	M10	6
10-50	10-50	4.0	M10	6
10-50	10-50	4.0	M10	6
35-95	35-95	20.0	M10	6

### TYPICAL ATTENUATION

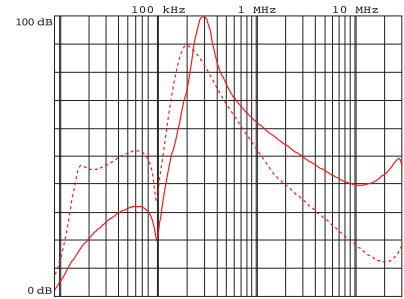

— Common Mode    - - - Differential Mode

Typical attenuation 7A – 400A

FIN538S1	Rated Current 40°C	Rated Current 50°C	Power Loss (W)
.250.V	272	250	80
.280.V	290	280	80
.280.BC	297	280	80
.320.BC	330	320	80
.360.BC	390	360	105
.400.BC	435	400	110
.500.BC	545	500	102
.600.BC	654	600	108
.750.BC	800	750	96
.900.BC	940	900	80
.1000.BC	1050	1000	115
.1250.BC	1290	1250	101
.1500.BC	1550	1500	120
.1600.BC	1650	1600	130
.1750.BC	1800	1750	135
.2000.BC	2040	2000	138
.2250.BC	2290	2250	145
.2500.BC	2535	2500	170
.3000.BC	3050	3000	180

LINE		PE	
d (mm)	Torque (Nm)	d 1 (mm)	Torque (Nm)
M12	20	M10	18
M12	20	M10	18
M8	14	M10	18
M8	14	M10	18
M8	14	M10	18
M8	14	M10	18
M8	14	M10	18
M10	25	M10	18
M10	25	M10	18
M12	50	M12	20
M12	50	M12	20
M12	50	M12	20
M12	50	M12	20
M12	50	M12	20
M12	50	M12	20
M12	50	M12	20
M12	50	M12	20
M12	50	M12	20

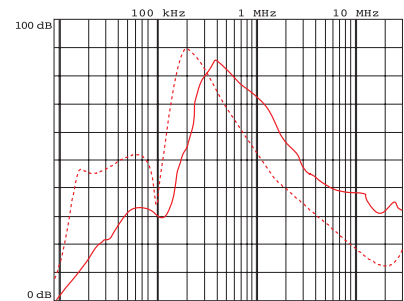

— Common Mode    - - - Differential Mode

Typical attenuation 500A – 3000A

### MECHANICAL DIMENSIONS mm

FIN538S1	A	B	V	V1	F	H	I	L	N	d	Weight Kg.	Case
.007.M	100	90	22	16	5.4	250	220	7.5	60	M6	1.3	1
.016.M	100	90	22	16	5.4	250	220	7.5	60	M6	1.3	1
.030.M	100	90	22	16	5.4	250	220	7.5	60	M6	1.3	1
.042.M	100	90	22	35	5.4	250	220	7.5	60	M6	1.5	2
.055.M	100	90	22	35	5.4	250	220	7.5	60	M6	1.5	2
.075.M	135	85	22	39	6.5	270	240	7.5	60	M6	2.2	3
.100.M	155	90	24	43	6.5	270	240	7.5	65	M10	3.2	4
.130.M	155	90	24	43	6.5	270	240	7.5	65	M10	3.2	4
.180.M	170	125	26	51	6.5	380	350	7.5	102	M10	5.5	5

### CASE 1, 2, 3, 4, 5

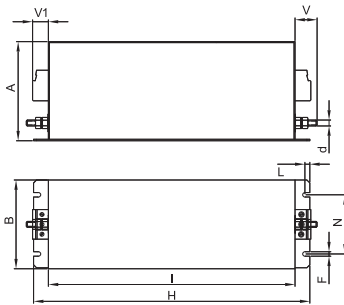

### ASSEMBLY CONNECTION "M"

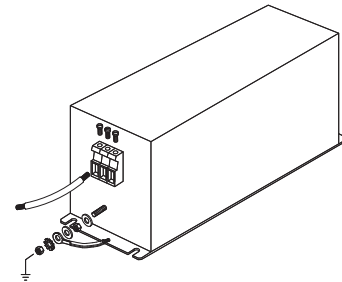

### MECHANICAL DIMENSIONS mm

FIN538S1	A	B	C	d	d1	V	F	H	I	L	N	P	S	Weight Kg.	Case
.250.V	90	220	120	M12	M10	30	6.5	356	320	340	95	70	60	9	6
.280.V	90	220	120	M12	M10	30	6.5	356	320	340	95	70	60	9	6

### CASE 6

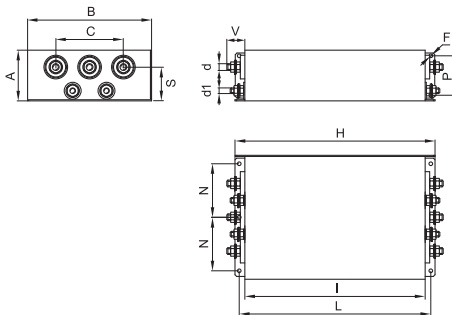

### ASSEMBLY CONNECTION "V"

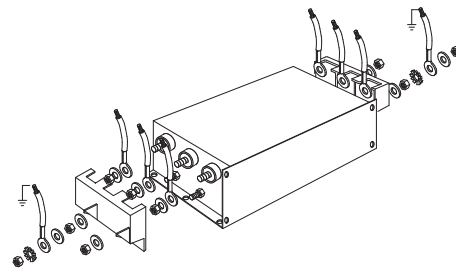

### MECHANICAL DIMENSIONS mm

FIN538S1	A	B	C	d	d1	d2	d3	V	F	H	I	L	N	P	S	Weight Kg.	Case
.280.BC	90	220	120	M8	M10	6	20	42	6.5	356	320	340	95	70	55	9	7
.320.BC	90	220	120	M8	M10	6	20	42	6.5	356	320	340	95	70	55	9	7
.360.BC	130	230	150	M8	M10	10	25	42	6.5	420	380	400	100	100	85	13.5	8
.400.BC	130	230	150	M8	M10	10	25	42	6.5	420	380	400	100	100	85	13.5	8
.500.BC	130	230	150	M8	M10	10	25	42	6.5	420	380	400	100	100	85	13.5	8
.600.BC	130	230	150	M12	M10	15	30	48	6.5	510	450	480	100	100	85	19	9
.750.BC	130	230	150	M12	M10	15	30	48	6.5	510	450	480	100	100	85	19	9
.900.BC	160	250	140	M12	M12	20	40	94	8.5	510	450	480	100	110	110	27	10
.1000.BC	160	250	140	M12	M12	20	40	94	8.5	510	450	480	100	110	110	27	10
.1250.BC	160	250	140	M12	M12	20	40	94	8.5	510	450	480	100	110	110	27	10
.1500.BC	180	300	200	M12	M12	20	60	97	8.5	560	500	530	125	130	117	30	11
.1600.BC	180	300	200	M12	M12	20	60	97	8.5	560	500	530	125	130	117	30	11
.1750.BC	180	300	200	M12	M12	20	60	97	8.5	560	500	530	125	130	117	30	11
.2000.BC	225	350	200	M12	M12	25	80	100	8.5	610	550	580	150	-	113	68	12
.2250.BC	225	350	200	M12	M12	25	80	100	8.5	610	550	580	150	-	113	68	12
.2500.BC	225	350	200	M12	M12	25	80	100	8.5	610	550	580	150	-	113	68	12
.3000.BC	225	350	200	M12	M12	25	80	100	8.5	610	550	580	150	-	113	68	12

### CASE 7, 8, 9

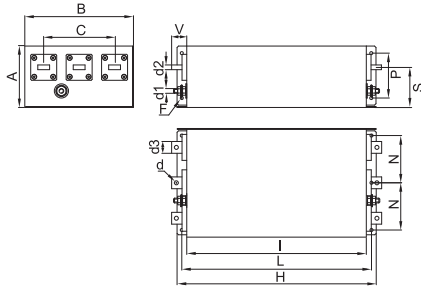

### ASSEMBLY CONNECTION "BC"

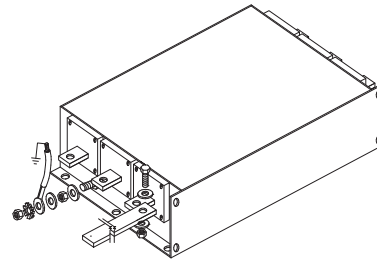

### CASE 10, 11

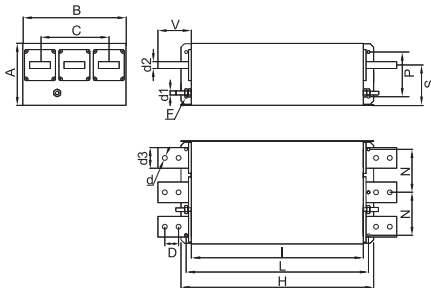

### ASSEMBLY CONNECTION "BC"

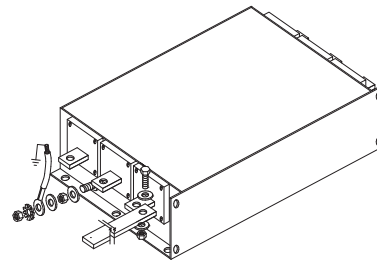

### CASE 12

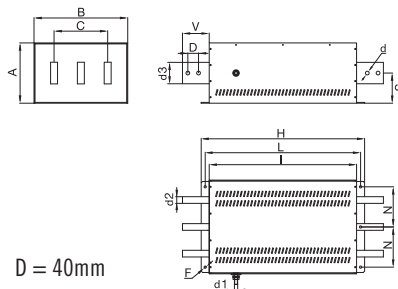

### ASSEMBLY CONNECTION "BC"

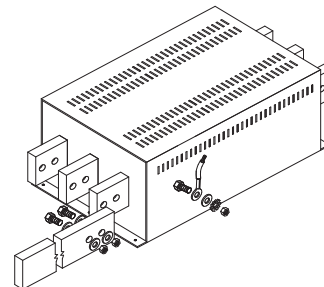



### EMI/RFI Filter with very high attenuation for industrial applications

Datasheet 3/2019

#### APPROVALS:

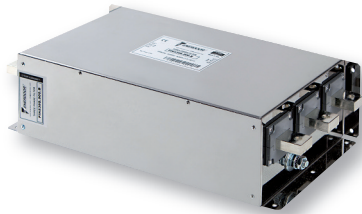

### FIN539S.(400 - 2500).B

#### FEATURES

- Rated current from 400 to 2500A
- Very high differential and common mode attenuation
- Low leakage current

#### BENEFITS

- 5 Year warranty
- Large bus bars allow ambient temperature of 70°C
- Compact design

#### MARKETS

- Renewable energy
- Uninterruptible power supplies
- Packaging machinery
- Process plants

#### ORDERING CODE

FIN539S .900 .M  
 Model Current (A) Connection  
 B = Bus bar

#### ATTENUATION INDICATOR

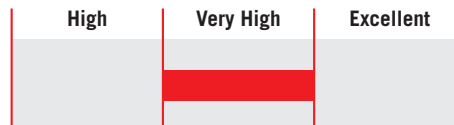

#### ELECTRIC DIAGRAM

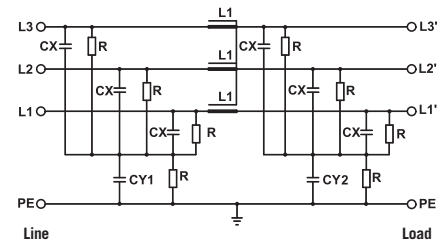

#### TECHNICAL SPECIFICATIONS

Nominal voltage	0 / 600 Vac
Frequency	50 – 60 Hz
Rated current	400 to 2500A
Potential test voltage phase to phase	2400 Vdc (2 sec.)
Potential test voltage phase to ground	3200 Vdc (2 sec.)
Leakage current normal conditions	< 10 mA *
Leakage current worst conditions	< 80 mA
IP Protection	IP00
Overload capability	IP 20 with FINPRT protection (optional) 4 x Rated current (Switch ON) 2 x In 10 seconds 1.5 In for 10 minutes
Climatic class	-40 / +85° C
MTBF at 40°C	250.000 Hrs

\* Voltage 230 Vac phase to ground 50 Hz / 40°C

### ELECTRICAL CHARACTERISTICS

FIN539S	Rated Current 40°C	Rated Current 50°C	Power Loss (W)
.400.B	420	400	92
.500.B	525	500	102
.600.B	630	600	82
.750.B	790	750	95
.900.B	945	900	105
.1000.B	1050	1000	92
.1250.B	1300	1300	98
.1500.B	1550	1500	108
.1750.B	1800	1750	105
.2000.B	2100	2000	92
.2250.B	2350	2250	98
.2500.B	2650	2500	108

### CONNECTIONS

LINE		PE	
d (mm)	Torque (Nm)	d 1 (mm)	Torque (Nm)
M8	14	M10	18
M8	14	M10	18
M8	14	M10	18
M10	25	M10	18
M10	25	M10	18
M12	50	M12	20
M12	50	M12	20
M12	50	M12	20
M12	50	M12	20
M12	50	M12	20
M12	50	M12	20

### TYPICAL ATTENUATION

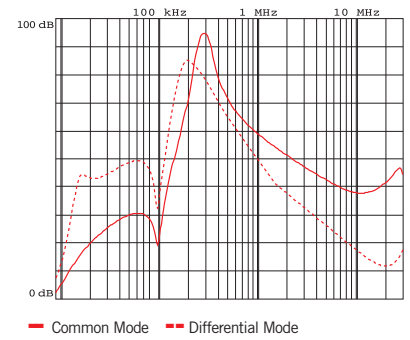

### MECHANICAL DIMENSIONS mm

FIN539S	A	B	C	d	d1	d2	d3	V	F	H	I	L	N	P	S	Weight Kg.	Case
.400.B	130	230	150	M8	M10	10	25	42	6.5	420	380	400	100	100	85	13.5	1
.500.B	130	230	150	M8	M10	10	25	42	6.5	420	380	400	100	100	85	13.5	1
.600.B	130	230	150	M8	M10	15	30	48	6.5	510	450	480	100	100	85	19	2
.750.B	130	230	150	M10	M10	15	30	48	6.5	510	450	480	100	100	85	19	2
.900.B	130	230	150	M10	M10	15	30	48	6.5	510	450	480	100	100	85	19	2
.1000.B	160	250	140	M12	M12	20	40	94	8.5	510	450	480	100	110	110	27	3
.1250.B	160	250	140	M12	M12	20	40	94	8.5	510	450	480	100	110	110	27	3
.1500.B	160	250	140	M12	M12	20	40	94	8.5	510	450	480	100	110	110	27	3
.1750.B	180	350	200	M12	M12	20	60	97	8.5	610	550	580	150	130	117	32	4
.2000.B	180	350	200	M12	M12	20	60	97	8.5	610	550	580	150	130	117	32	4
.2250.B	180	350	200	M12	M12	20	60	97	8.5	610	550	580	150	130	117	32	4
.2500.B	180	350	200	M12	M12	20	60	97	8.5	610	550	580	150	130	117	32	4

### CASE 1, 2, 3, 4

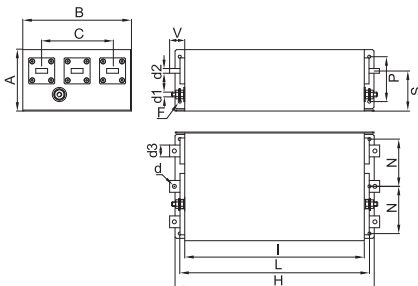

### ASSEMBLY CONNECTION "B"

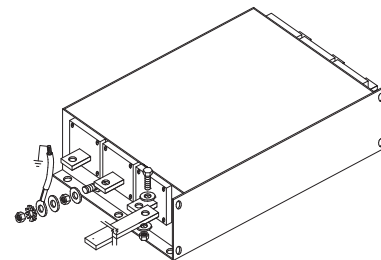





### EMI/RFI Filter with excellent attenuation for industrial applications

Datasheet 3/2019

#### APPROVALS:

UL1283  
CSA C22.2  
E215863



SCCR by UL508A



**FIN1200.(005 - 280).V**

#### FEATURES

- Rated current from 5 to 3000A
- Excellent differential and common mode attenuation
- Very low leakage current

#### BENEFITS

- 5 Year warranty
- Various connections available
- Finger safe protection available
- Vertical bus bar available

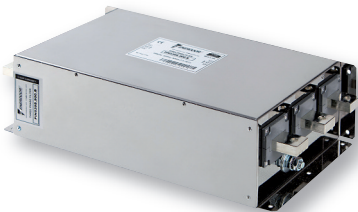

**FIN1200.(280 - 1750).BC**

#### MARKETS

- Electrical equipment
- Semiconductor equipment
- Industrial automation
- Variable frequency drives / servo drives
- MRI - Medical equipment
- Renewable energy

#### ORDERING CODE

FIN1200(HV) .100 .V  
 Model Current (A) Connection  
 HV = 600Vac V = Screw  
 BC = Bus bar

#### ATTENUATION INDICATOR



#### ELECTRIC DIAGRAM

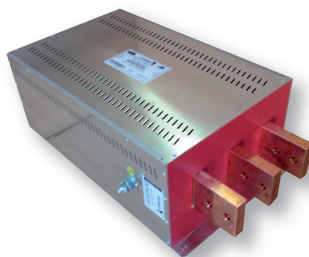
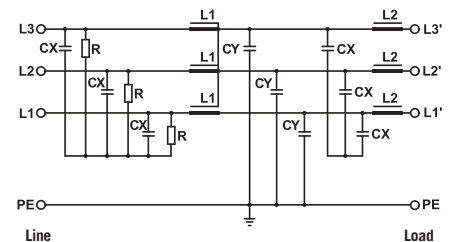

**FIN1200.(2000 - 3000).BC**

#### TECHNICAL SPECIFICATIONS

	FIN1200	FIN1200HV
Nominal voltage	0 / 480 Vac	0 / 600 Vac
Frequency	50 – 60 Hz	
Rated current	5 to 3000A	
Potential test voltage phase to phase	2200 Vdc (2 sec.)	2400 Vdc (2 sec.)
Potential test voltage phase to ground	2900 Vdc (2 sec.)	3200 Vdc (2 sec.)
Leakage current normal conditions	< 3 mA *	
Leakage current worst conditions	< 10 mA	
IP Protection	IP20 up to 280A IP00 over 280A (IP 20 available with protection FINPRT)	
Overload capability	4 x Rated current (Switch ON) 2 x In 10 seconds 1.5 In for 10 minutes	
Climatic class	-40 / +85° C	
MTBF at 40°C	250.000 Hrs	

FIN1200HV AVAILABLE UP TO 750Vac

\* Voltage 230 Vac phase to ground 50Hz / 40°C

### ELECTRICAL CHARACTERISTICS

FIN1200 FIN1200HV	Rated Current 40°C	Rated Current 50°C	Power Loss (W)
.005.V	5	4	5
.010.V	10	8	7
.016.V	16	14	14
.030.V	30	27	11
.050.V	50	46	10
.080.V	80	75	35
.100.V	100	90	42
.150.V	150	140	74
.200.V	200	190	90
.250.V	272	250	90
.280.V	290	280	80
.280.BC	297	280	78
.320.BC	330	320	80
.360.BC	390	360	105
.400.BC	435	400	110
.500.BC	545	500	102
.600.BC	654	600	108
.750.BC	800	750	96
.900.BC	940	900	80
.1000.BC	1050	1000	115
.1250.BC	1290	1250	101
.1500.BC	1550	1500	120
.1600.BC	1650	1600	130
.1750.BC	1800	1750	135
.2000.BC	2050	2000	138
.2250.BC	2300	2250	145
.2500.BC	2550	2500	170
.3000.BC	3000	2950	180

### CONNECTIONS

LINE		PE	
d (mm)	Torque (Nm)	d1 (mm)	Torque (Nm)
M4	1.2	M4	1.2
M4	1.2	M4	1.2
M5	4	M5	4
M5	4	M5	4
M6	6	M5	4
M8	14	M8	14
M8	14	M8	14
M10	18	M10	18
M10	18	M10	18
M12	20	M10	18
M12	20	M10	18
M8	14	M10	18
M8	14	M10	18
M8	14	M10	18
M8	14	M10	18
M10	25	M10	18
M10	25	M10	18
M12	50	M12	20
M12	50	M12	20
M12	50	M12	20
M12	50	M12	20
M12	50	M12	20
M12	50	M12	20
M12	50	M12	20
M12	50	M12	20
M12	50	M12	20

### TYPICAL ATTENUATION

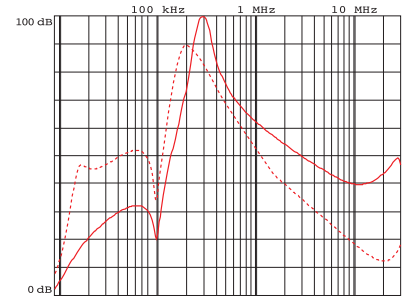

— Common Mode    - - - Differential Mode

**Typical attenuation 5A – 400A**

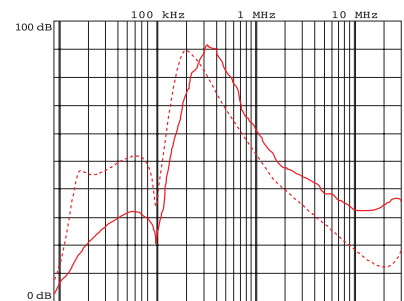

— Common Mode    - - - Differential Mode

**Typical attenuation 500A – 3000A**

### MECHANICAL DIMENSIONS mm

FIN1200 FIN1200HV	A	B	C	d	d1	V	F	H	I	L	N	P	S	Weight Kg.	Case
.005.V	58	86	44	M4	M4	14	4.5	186	160	176	30	40	38	2	1
.010.V	58	86	44	M4	M4	14	4.5	186	160	176	30	40	38	2	1
.016.V	90	100	46	M5	M5	28	4.5	246	220	235	35	70	64	3	2
.030.V	90	100	46	M5	M5	28	4.5	246	220	235	35	70	64	3	2
.050.V	90	100	46	M6	M5	28	4.5	246	220	235	35	70	64	3	3
.080.V	90	185	84	M8	M8	25	6.5	356	320	340	77.5	70	69	5	4
.100.V	90	185	84	M8	M8	25	6.5	356	320	340	77.5	70	69	5	4
.150.V	90	220	120	M10	M10	29	6.5	356	320	340	95	70	60	7	5
.200.V	90	220	120	M10	M10	29	6.5	356	320	340	95	70	60	7	5
.250.V	90	220	120	M12	M10	30	6.5	356	320	340	95	70	60	9	6
.280.V	90	220	120	M12	M10	30	6.5	356	320	340	95	70	60	9	6

### CASE 1, 2, 3, 4

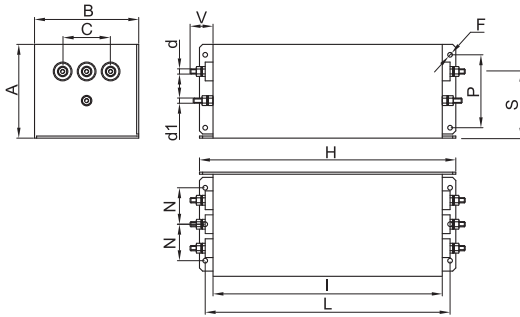

### ASSEMBLY CONNECTION "V"

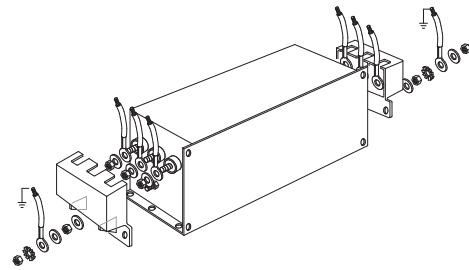

### CASE 5, 6

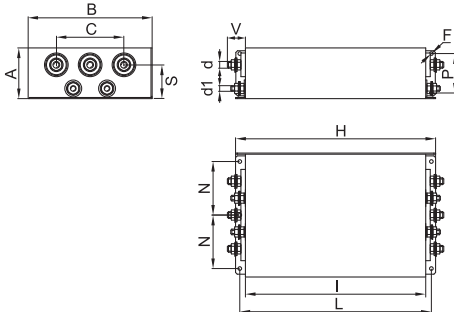

### ASSEMBLY CONNECTION "V"

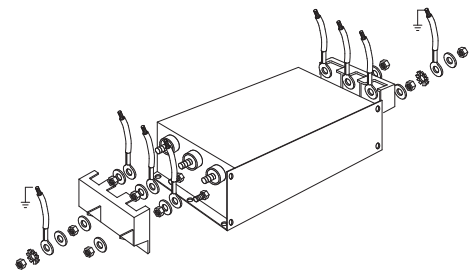

### MECHANICAL DIMENSIONS mm

FIN1200 FIN1200HV	A	B	C	d	d1	d2	d3	V	F	H	I	L	N	P	S	Weight Kg.	Case
.280.BC	90	220	120	M8	M10	6	20	42	6.5	356	320	340	95	70	55	9	7
.320.BC	90	220	120	M8	M10	6	20	42	6.5	356	320	340	95	70	55	9	7
.360.BC	130	230	150	M8	M10	10	25	42	6.5	420	380	400	100	100	85	13.5	8
.400.BC	130	230	150	M8	M10	10	25	42	6.5	420	380	400	100	100	85	13.5	8
.500.BC	130	230	150	M8	M10	10	25	42	6.5	420	380	400	100	100	85	13.5	8
.600.BC	130	230	150	M12	M10	15	30	48	6.5	510	450	480	100	100	85	19	9
.750.BC	130	230	150	M12	M10	15	30	48	6.5	510	450	480	100	100	85	19	9
.900.BC	160	250	140	M12	M12	20	40	94	8.5	510	450	480	100	110	110	27	10
.1000.BC	160	250	140	M12	M12	20	40	94	8.5	510	450	480	100	110	110	27	10
.1250.BC	160	250	140	M12	M12	20	40	94	8.5	510	450	480	100	110	110	27	10
.1500.BC	180	300	200	M12	M12	20	60	97	8.5	560	500	530	125	130	117	30	11
.1600.BC	180	300	200	M12	M12	20	60	97	8.5	560	500	530	125	130	117	30	11
.1750.BC	180	300	200	M12	M12	20	60	97	8.5	560	500	530	125	130	117	30	11
.2000.BC	225	350	200	M12	M12	25	80	100	8.5	610	550	580	150	-	113	68	12
.2250.BC	225	350	200	M12	M12	25	80	100	8.5	610	550	580	150	-	113	68	12
.2500.BC	225	350	200	M12	M12	25	80	100	8.5	610	550	580	150	-	113	68	12
.3000.BC	225	350	200	M12	M12	25	80	100	8.5	610	550	580	150	-	113	68	12

### CASE 7, 8, 9

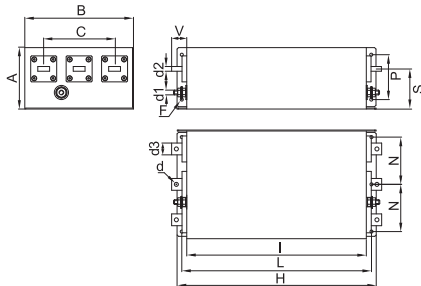

### ASSEMBLY CONNECTION "BC"

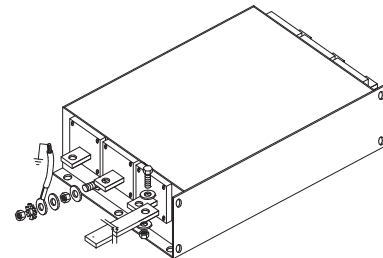

### CASE 10, 11

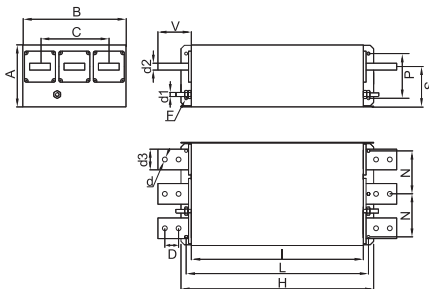

### ASSEMBLY CONNECTION "BC"

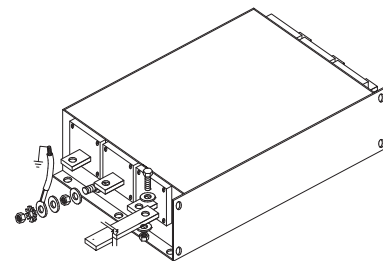

### CASE 12

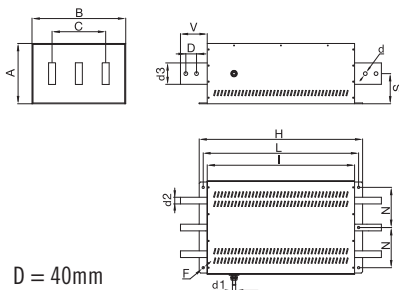

### ASSEMBLY CONNECTION "BC"

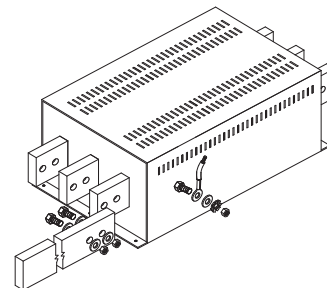



### EMI/RFI Filter with excellent attenuation for industrial applications

Datasheet 3/2019

#### APPROVALS:

UL1283  
CSA C22.2  
E215863

RoHS



SCCR by UL508A



**FIN1500.(005 - 280).V**

#### FEATURES

- Rated current from 5 to 3000A
- Excellent differential and common mode attenuation
- Low leakage current

#### BENEFITS

- 5 Year warranty
- Various connections
- Finger safe protection available
- Vertical bus bar available



**FIN1500.(280 - 1750).BC**

#### MARKETS

- Electrical equipment
- Machine tools
- Industrial automation
- Variable frequency drives / servo drives
- Regenerative system
- Renewable energy

#### ORDERING CODE

FIN1500(HV) .100	.V
Model	Current (A) Connection
HV = 600Vac	V = Screw BC = Bus bar

#### ATTENUATION INDICATOR

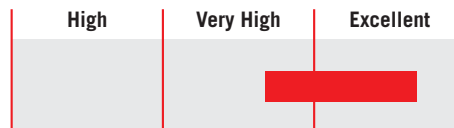

#### ELECTRIC DIAGRAM

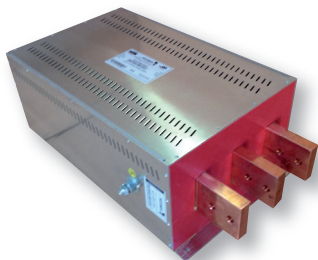
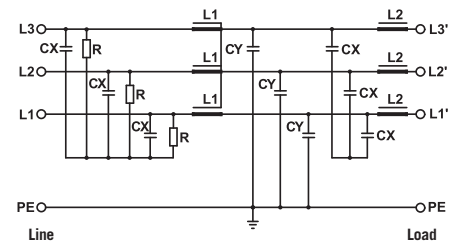

**FIN1500.(1750 - 3000).BC**

#### TECHNICAL SPECIFICATIONS

	FIN1500	FIN1500HV
Nominal voltage	0 / 480 Vac	0 / 600 Vac
Frequency	50 - 60 Hz	
Rated current	5 to 3000A	
Potential test voltage phase to phase	2200 Vdc (2 sec.)	2400 Vdc (2 sec.)
Potential test voltage phase to ground	2900 Vdc (2 sec.)	3200 Vdc (2 sec.)
Leakage current normal conditions	<10 mA*	
Leakage current worst conditions	<35 mA	
IP Protection	IP20 up to 280A IP00 over 280A (IP 20 available with protection FINPRT)	
Overload capability	4 x Rated current (Switch ON) 2 x In 10 seconds 1.5 In for 10 minutes	
Climatic class	-40 / +85° C	
MTBF at 40°C	250.000 Hrs	

\* Voltage 230 Vac phase to ground 50Hz / 40°C

### ELECTRICAL CHARACTERISTICS

FIN1500 FIN1500HV	Rated Current 40°C	Rated Current 50°C	Power Loss (W)
.005.V	5	4	5
.010.V	10	8	7
.016.V	16	14	14
.030.V	30	27	11
.050.V	50	46	10
.080.V	80	75	35
.100.V	100	90	42
.150.V	150	140	74
.200.V	200	190	90
.250.V	272	250	90
.280.V	290	280	80
.280.BC	297	280	78
.320.BC	330	320	80
.360.BC	390	360	105
.400.BC	435	400	110
.500.BC	545	500	102
.600.BC	654	600	108
.750.BC	800	750	96
.900.BC	940	900	80
.1000.BC	1050	1000	115
.1250.BC	1290	1250	101
.1500.BC	1550	1500	120
.1600.BC	1650	1600	130
.1750.BC	1800	1750	135
.2000.BC	2050	2000	138
.2250.BC	2300	2250	145
.2500.BC	2550	2500	170
.3000.BC	3000	2950	180

### CONNECTIONS

LINE		PE	
d (mm)	Torque (Nm)	d1 (mm)	Torque (Nm)
M4	1.2	M4	1.2
M4	1.2	M4	1.2
M5	4	M5	4
M5	4	M5	4
M6	6	M5	4
M8	14	M8	14
M8	14	M8	14
M10	18	M10	18
M10	18	M10	18
M12	20	M10	18
M12	20	M10	18
M8	14	M10	18
M8	14	M10	18
M8	14	M10	18
M8	14	M10	18
M10	25	M10	18
M10	25	M10	18
M12	50	M12	20
M12	50	M12	20
M12	50	M12	20
M12	50	M12	20
M12	50	M12	20
M12	50	M12	20
M12	50	M12	20
M12	50	M12	20

### TYPICAL ATTENUATION

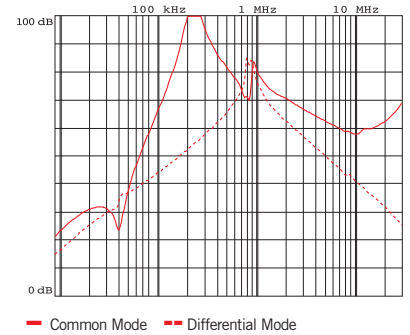

Typical attenuation 5A – 400A

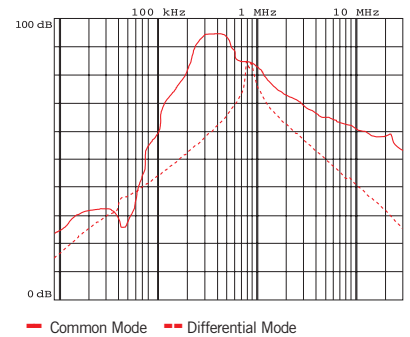

Typical attenuation 500A – 3000A

### MECHANICAL DIMENSIONS mm

FIN1500 FIN1500HV	A	B	C	d	d1	V	F	H	I	L	N	P	S	Weight Kg.	Case
.005.V	58	86	44	M4	M4	14	4.5	186	160	176	30	40	38	2	1
.010.V	58	86	44	M4	M4	14	4.5	186	160	176	30	40	38	2	1
.016.V	90	100	46	M5	M5	28	4.5	246	220	235	35	70	64	3	2
.030.V	90	100	46	M5	M5	28	4.5	246	220	235	35	70	64	3	2
.050.V	90	100	46	M6	M5	28	4.5	246	220	235	35	70	64	3	3
.080.V	90	185	84	M8	M8	25	6.5	356	320	340	77.5	70	69	5	4
.100.V	90	185	84	M8	M8	25	6.5	356	320	340	77.5	70	69	5	4
.150.V	90	220	120	M10	M10	29	6.5	356	320	340	95	70	60	7	5
.200.V	90	220	120	M10	M10	29	6.5	356	320	340	95	70	60	7	5
.250.V	90	220	120	M12	M10	30	6.5	356	320	340	95	70	60	9	6
.280.V	90	220	120	M12	M10	30	6.5	356	320	340	95	70	60	9	6

### CASE 1, 2, 3, 4

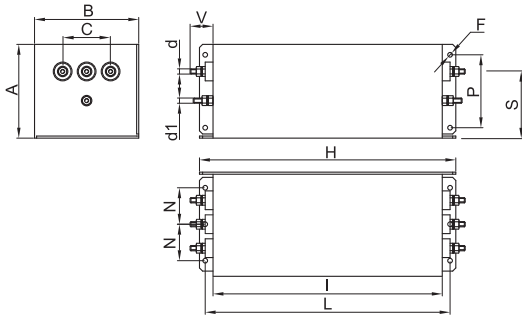

### ASSEMBLY CONNECTION "V"

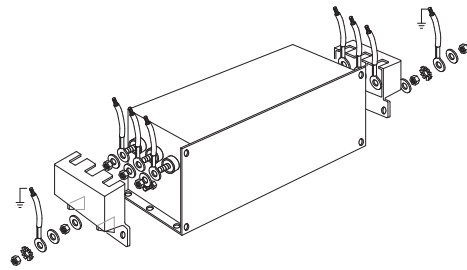

### CASE 5, 6

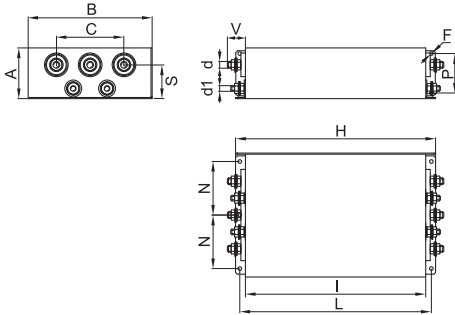

### ASSEMBLY CONNECTION "V"

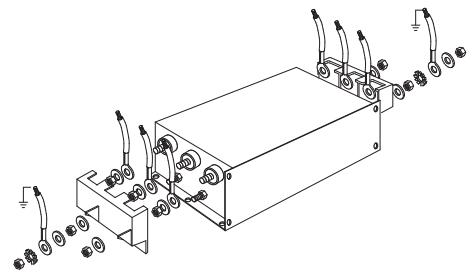



### MECHANICAL DIMENSIONS mm

FIN1500 FIN1500HV	A	B	C	d	d1	d2	d3	V	F	H	I	L	N	P	S	Weight Kg.	Case
.280.BC	90	220	120	M8	M10	6	20	42	6.5	356	320	340	95	70	55	9	7
.320.BC	90	220	120	M8	M10	6	20	42	6.5	356	320	340	95	70	55	9	7
.360.BC	130	230	150	M8	M10	10	25	42	6.5	420	380	400	100	100	85	13.5	8
.400.BC	130	230	150	M8	M10	10	25	42	6.5	420	380	400	100	100	85	13.5	8
.500.BC	130	230	150	M8	M10	10	25	42	6.5	420	380	400	100	100	85	13.5	8
.600.BC	130	230	150	M12	M10	15	30	48	6.5	510	450	480	100	100	85	19	9
.750.BC	130	230	150	M12	M10	15	30	48	6.5	510	450	480	100	100	85	19	9
.900.BC	160	250	140	M12	M12	20	40	94	8.5	510	450	480	100	110	110	27	10
.1000.BC	160	250	140	M12	M12	20	40	94	8.5	510	450	480	100	110	110	27	10
.1250.BC	160	250	140	M12	M12	20	40	94	8.5	510	450	480	100	110	110	27	10
.1500.BC	180	300	200	M12	M12	20	60	97	8.5	560	500	530	125	130	117	30	11
.1600.BC	180	300	200	M12	M12	20	60	97	8.5	560	500	530	125	130	117	30	11
.1750.BC	180	300	200	M12	M12	20	60	97	8.5	560	500	530	125	130	117	30	11
.2000.BC	225	350	200	M12	M12	25	80	100	8.5	610	550	580	150	-	113	68	12
.2250.BC	225	350	200	M12	M12	25	80	100	8.5	610	550	580	150	-	113	68	12
.2500.BC	225	350	200	M12	M12	25	80	100	8.5	610	550	580	150	-	113	68	12
.3000.BC	225	350	200	M12	M12	25	80	100	8.5	610	550	580	150	-	113	68	12

### CASE 7, 8, 9

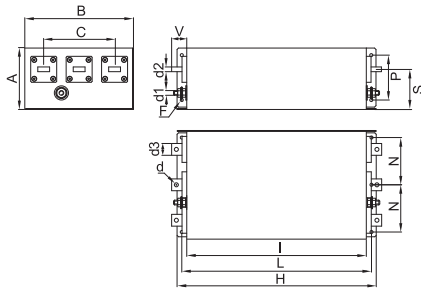

### ASSEMBLY CONNECTION "BC"

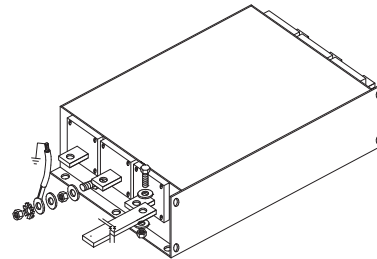

### CASE 10, 11

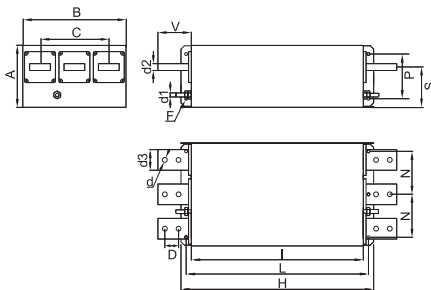

### ASSEMBLY CONNECTION "BC"

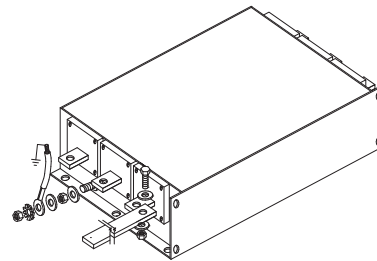

### CASE 12

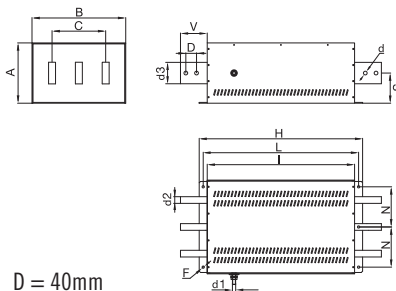

### ASSEMBLY CONNECTION "BC"

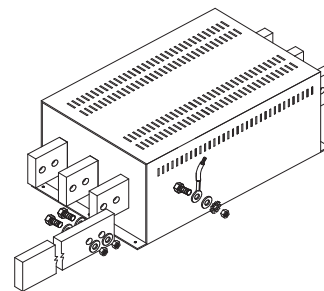



## EMI/RFI Filter with very high attenuation for industrial applications

Datasheet 3/2019

**APPROVALS:**

**FIN1600.(007 – 200).M**
**FEATURES**

- Rated current from 7 to 200A
- Very high differential and common mode attenuation

**BENEFITS**

- 5 Year warranty
- Safety terminal block connector
- Compact design

**MARKETS**

- Elevators
- Processing machinery
- Regeneration systems
- Uninterruptible power supplies

**ORDERING CODE**

FIN1600 .055 .M  
 Model Current (A) Connection  
 M = Terminal block

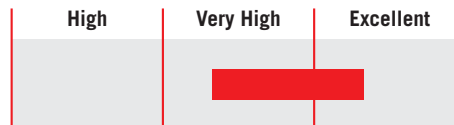
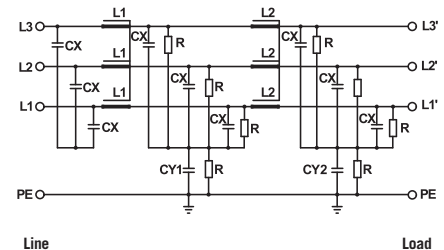
**ATTENUATION INDICATOR**

**ELECTRIC DIAGRAM**

**TECHNICAL SPECIFICATIONS**

Nominal voltage	0 / 480 Vac
Frequency	50 – 60 Hz
Rated current	7 to 200A
Potential test voltage phase to phase	2200 Vdc (2 sec.)
Potential test voltage phase to ground	2900 Vdc (2 sec.)
Leakage current normal conditions	< 10 mA *
Leakage current worst conditions	< 130 mA
IP Protection	IP20
Overload capability	4 x Rated current (Switch ON) 2 x In 10 seconds 1.5 In for 10 minutes
Climatic class	-40 / +85° C
MTBF at 40°C	250.000 Hrs

\* Voltage 230 Vac phase to ground 50 Hz / 40°C

### ELECTRICAL CHARACTERISTICS

FIN1600	Rated Current 40°C	Rated Current 50°C	Power Loss (W)
.007.M	7	5	6
.013.M	13	11	10
.018.M	18	16	12
.034.M	34	30	24
.055.M	55	50	27
.090.M	90	80	37
.110.M	110	100	67
.160.M	160	150	100
.200.M	200	180	93

### CONNECTIONS

LINE			PE	
Solid Cable (mm <sup>2</sup> )	Stranded Cable (mm <sup>2</sup> )	Terminal Torque (Nm)	d (mm)	Torque (Nm)
0.2 - 6	0.2 - 4	0.5	M5	0.5
0.2 - 6	0.2 - 4	0.5	M5	0.5
0.2 - 6	0.2 - 4	0.5	M5	0.5
0.2 - 10	0.2 - 6	1.2	M5	1.2
0.5 - 16	0.5 - 10	1.8	M6	1.8
4 - 25	6 - 35	4.5	M6	4.5
10 - 50	10 - 50	4	M10	4
10 - 50	10 - 50	4	M10	4
35 - 95	35 - 95	20	M10	20

### TYPICAL ATTENUATION

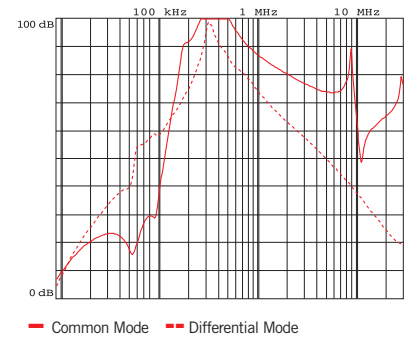

### MECHANICAL DIMENSIONS mm

FIN1600	A	B	V	V1	F	H	I	L	N	d	Weight Kg.	Case
.007.M	126	50	19	11	6.5	255	225	7.5	25	M5	1.6	1
.013.M	126	50	19	11	6.5	255	225	7.5	25	M5	1.6	1
.018.M	143	55	19	11	6.5	305	276	7.5	30	M5	2.2	1
.034.M	150	60	19	16	6.5	335	305	7.5	35	M5	2.7	1
.055.M	185	70	18	33	6.5	329	300	7.5	45	M6	4.7	1
.090.M	220	80	18	39	6.5	329	300	7.5	55	M6	5.5	1
.110.M	220	90	28	43	6.5	379	350	7.5	65	M10	7.7	1
.160.M	240	110	28	43	6.5	439	400	12.5	65	M10	11	1
.200.M	240	110	28	50	6.5	439	400	12.5	65	M10	12	1

### CASE 1

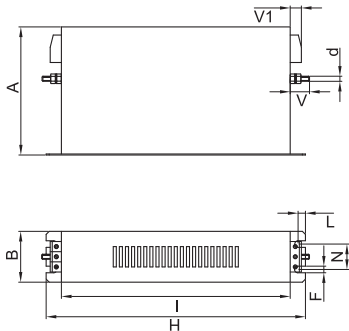

### ASSEMBLY CONNECTION "M"

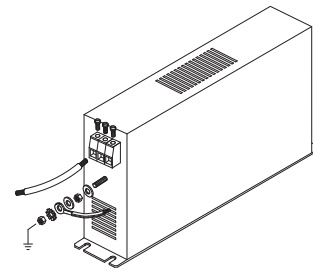



### EMI/RFI Filter with very high attenuation for industrial applications

Datasheet 3/2019



**FIN1700.(006 - 200).M**

#### FEATURES

- Rated current from 6 to 200A
- Very high differential and common mode attenuation
- Very low leakage current

#### MARKETS

- Food industry
- Woodworking machinery
- Packaging machinery
- Printing machinery

#### APPROVALS:

UL1283  
CSA C22.2  
E215863

**RoHS**



**SCCR** by UL508A

#### BENEFITS

- 5 Year warranty
- Safety terminal block connector
- Helps pass immunity and emission tests for the IEC61000-6-2 and IEC61000-6-4 Standards

#### ORDERING CODE

FIN1700 .055 .M  
Model Current (A) Connection  
M = Terminal block

#### ATTENUATION INDICATOR

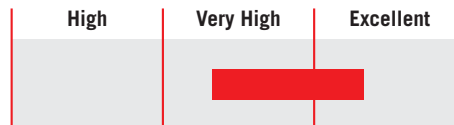

#### ELECTRIC DIAGRAM

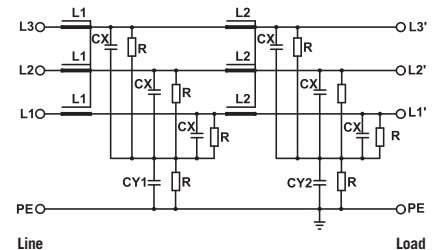

#### TECHNICAL SPECIFICATIONS

Nominal voltage	0 / 600 Vac
Frequency	50 – 60 Hz
Rated current	6 to 200A
Potential test voltage phase to phase	2400 Vdc (2 sec.)
Potential test voltage phase to ground	3200 Vdc (2 sec.)
Leakage current normal conditions	< 3 mA *
Leakage current worst conditions	< 15 mA
IP Protection	IP20
Overload capability	4 x Rated current (Switch ON) 2 x In 10 seconds 1.5 In for 10 minutes
Climatic class	-40 / +85° C
MTBF at 40°C	250.000 Hrs

\* Voltage 230 Vac phase to ground 50 Hz / 40°C

### ELECTRICAL CHARACTERISTICS

FIN1700	Rated Current 40°C	Rated Current 50°C	Power Loss (W)
.006.M	8	6	8
.012.M	14	12	10
.016.M	18	16	12
.025.M	28	25	15
.032.M	35	32	23
.042.M	50	42	32
.055.M	63	55	37
.070.M	80	70	52
.080.M	90	80	60
.100.M	110	100	92
.115.M	130	115	101
.150.M	175	150	115
.200.M	230	200	120

### CONNECTIONS

LINE			PE	
Solid Cable (mm <sup>2</sup> )	Stranded Cable (mm <sup>2</sup> )	Terminal Torque (Nm)	d (mm)	Torque (Nm)
0.2 - 10	0.2 - 6	1.2	M6	6
0.2 - 10	0.2 - 6	1.2	M6	6
0.2 - 10	0.2 - 6	1.2	M6	6
0.2 - 10	0.2 - 6	1.2	M6	6
0.2 - 10	0.2 - 6	1.2	M6	6
0.5 - 16	0.5 - 10	1.8	M6	6
0.5 - 16	0.5 - 10	1.8	M6	6
4 - 25	6 - 35	4.5	M10	18
4 - 25	6 - 35	4.5	M10	18
10 - 50	10 - 50	4	M10	18
10 - 50	10 - 50	4	M10	18
35 - 95	35 - 95	20	M10	18
35 - 95	35 - 95	20	M10	18

### TYPICAL ATTENUATION

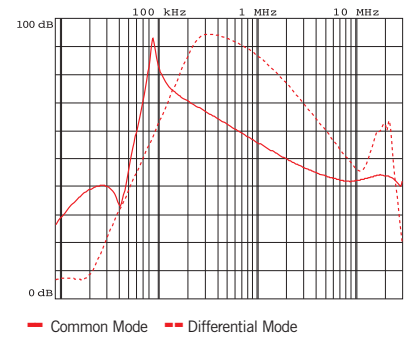

### MECHANICAL DIMENSIONS mm

FIN1700	A	B	V	V1	F	H	I	L	N	d	Weight Kg.	Case
.006.M	140	50	19	15	6	226	200	7	28	M6	1.7	1
.012.M	140	50	19	15	6	226	200	7	28	M6	1.7	1
.016.M	177	60	19	15	6	267	237	8	34	M6	1.7	1
.025.M	177	60	19	15	6	267	237	8	34	M6	2.3	1
.032.M	177	60	19	15	6	267	237	8	34	M6	2.3	1
.042.M	177	70	19	25	6	295	265	8	44	M6	3.4	1
.055.M	177	70	19	33	6	295	265	8	44	M6	3.5	1
.070.M	205	80	28	38	8	390	340	12	53	M10	6	1
.080.M	205	80	28	38	8	390	340	12	53	M10	6	1
.100.M	205	80	28	43	8	390	340	12	53	M10	7.1	1
.115.M	205	80	28	43	8	390	340	12	53	M10	7.1	1
.150.M	220	105	28	50	8	420	370	12	78	M10	8.5	1
.200.M	220	105	28	50	8	420	370	12	78	M10	8.5	1

### CASE 1

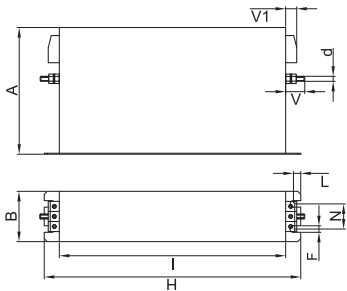

### ASSEMBLY CONNECTION "M"

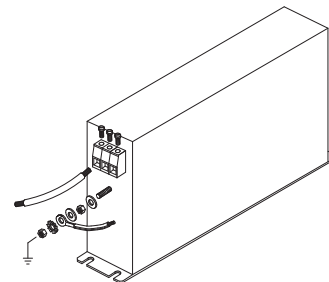



### EMI/RFI Filter with very high attenuation for industrial applications

Datasheet 3/2019



**FIN1700G.(006 - 200).M**

#### FEATURES

- Rated current from 6 to 200A
- Very high differential and common mode attenuation
- Very low leakage current
- High attenuation in the low frequency range 100 kHz – 2 MHz

#### MARKETS

- Food industry
- Woodworking machinery
- Packaging machinery
- Printing machinery

#### APPROVALS:

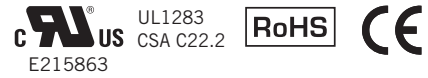

**SCCR** by UL508A

#### BENEFITS

- 5 Year warranty
- Safety terminal block connector
- Helps pass immunity and emission tests for the IEC61000-6-2 and IEC61000-6-4 Standards

#### ORDERING CODE

FIN1700G .055 .M  
 Model Current (A) Connection  
 M = Terminal block

#### ATTENUATION INDICATOR



#### ELECTRIC DIAGRAM

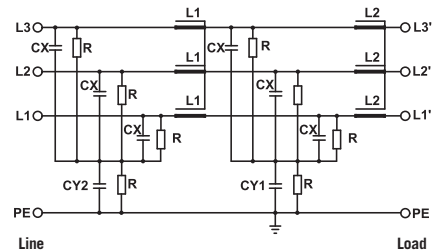

#### TECHNICAL SPECIFICATIONS

Nominal voltage	0 / 600 Vac
Frequency	50 – 60 Hz
Rated current	6 to 200A
Potential test voltage phase to phase	2400 Vdc (2 sec.)
Potential test voltage phase to ground	3200 Vdc (2 sec.)
Leakage current normal conditions	< 3 mA *
Leakage current worst conditions	< 15 mA
IP Protection	IP20
Overload capability	4 x Rated current (Switch ON) 2 x In 10 seconds 1.5 In for 10 minutes
Climatic class	-40 / +85° C
MTBF at 40°C	250.000 Hrs

\* Voltage 230 Vac phase to ground 50 Hz / 40°C

### ELECTRICAL CHARACTERISTICS

FIN1700G	Rated Current 40°C	Rated Current 50°C	Power Loss (W)
.006.M	8	6	8
.012.M	14	12	10
.016.M	18	16	12
.025.M	28	25	15
.032.M	35	32	23
.042.M	50	42	32
.055.M	63	55	37
.070.M	80	70	52
.080.M	90	80	60
.100.M	110	100	92
.115.M	130	115	101
.150.M	175	150	115
.200.M	230	200	120

### CONNECTIONS

LINE			PE	
Solid Cable (mm <sup>2</sup> )	Stranded Cable (mm <sup>2</sup> )	Terminal Torque (Nm)	d (mm)	Torque (Nm)
0.2 - 10	0.2 - 6	1.2	M6	6
0.2 - 10	0.2 - 6	1.2	M6	6
0.2 - 10	0.2 - 6	1.2	M6	6
0.2 - 10	0.2 - 6	1.2	M6	6
0.2 - 10	0.2 - 6	1.2	M6	6
0.5 - 16	0.5 - 10	1.8	M6	6
0.5 - 16	0.5 - 10	1.8	M6	6
4 - 25	6 - 35	4.5	M10	18
4 - 25	6 - 35	4.5	M10	18
10 - 50	10 - 50	4	M10	18
10 - 50	10 - 50	4	M10	18
35 - 95	35 - 95	20	M10	18
35 - 95	35 - 95	20	M10	18

### TYPICAL ATTENUATION

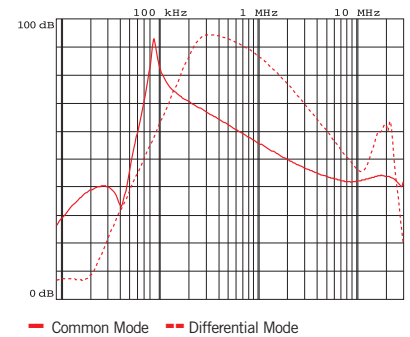

### MECHANICAL DIMENSIONS mm

FIN1700G	A	B	V	V1	F	H	I	L	N	d	Weight Kg.	Case
.006.M	140	50	19	15	6	226	200	7	28	M6	1.7	1
.012.M	140	50	19	15	6	226	200	7	28	M6	1.7	1
.016.M	177	60	19	15	6	267	237	8	34	M6	1.7	1
.025.M	177	60	19	15	6	267	237	8	34	M6	2.3	1
.032.M	177	60	19	15	6	267	237	8	34	M6	2.3	1
.042.M	177	70	19	25	6	295	265	8	44	M6	3.4	1
.055.M	177	70	19	33	6	295	265	8	44	M6	3.5	1
.070.M	205	80	28	38	8	390	340	12	53	M10	6	1
.080.M	205	80	28	38	8	390	340	12	53	M10	6	1
.100.M	205	80	28	43	8	390	340	12	53	M10	7.1	1
.115.M	205	80	28	43	8	390	340	12	53	M10	7.1	1
.150.M	220	105	28	50	8	420	370	12	78	M10	8.5	1
.200.M	220	105	28	50	8	420	370	12	78	M10	8.5	1

### CASE 1

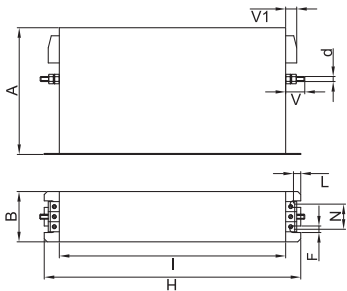

### ASSEMBLY CONNECTION "M"

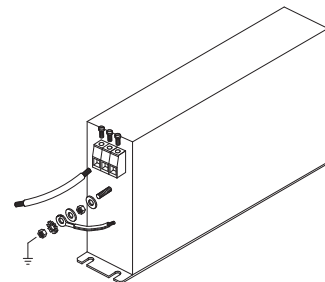





### EMI/RFI Filter with very high attenuation for industrial applications

Datasheet 3/2019



**FIN1700E.(007 - 230).M**

#### FEATURES

- Rated current from 7 to 230A
- Very high differential and common mode attenuation
- Very low leakage current

#### MARKETS

- Packaging machinery
- Printing machinery
- Variable frequency drives / servo drives
- Medical equipment

#### APPROVALS:

UL1283  
CSA C22.2  
E215863



**SCCR** by UL508A

#### BENEFITS

- 5 Year warranty
- Safety terminal block connector
- Very compact design

#### ORDERING CODE

FIN1700E .070 .M  
Model Current (A) Connection  
M = Terminal block

#### ATTENUATION INDICATOR

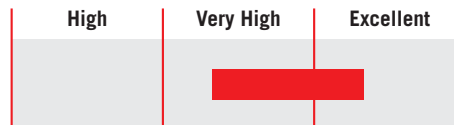

#### ELECTRIC DIAGRAM

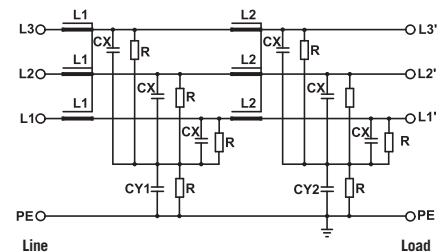

#### TECHNICAL SPECIFICATIONS

Nominal voltage	0 / 500 Vac
Frequency	50 – 60 Hz
Rated current	7 to 230A
Potential test voltage phase to phase	2300 Vdc (2 sec.)
Potential test voltage phase to ground	3100 Vdc (2 sec.)
Leakage current normal conditions	< 3 mA *
Leakage current worst conditions	< 15 mA
IP Protection	IP20
Overload capability	4 x Rated current (Switch ON) 2 x In 10 seconds 1.5 In for 10 minutes
Climatic class	-40 / +85° C
MTBF at 40°C	250.000 Hrs

\* Voltage 230 Vac phase to ground 50 Hz / 40°C

### ELECTRICAL CHARACTERISTICS

FIN1700E	Rated Current 40°C	Rated Current 50°C	Power Loss (W)
.007.M	7	6	8
.013.M	13	12	12
.018.M	18	16	15
.027.M	27	25	20
.034.M	34	32	32
.040.M	40	36	23
.055.M	55	50	42
.070.M	70	64	55
.100.M	100	90	60
.110.M	110	100	90
.130.M	130	120	98
.150.M	150	135	103
.200.M	200	180	115
.230.M	230	210	120

### CONNECTIONS

LINE			PE	
Solid Cable (mm <sup>2</sup> )	Stranded Cable (mm <sup>2</sup> )	Terminal Torque (Nm)	d (mm)	Torque (Nm)
0.2 - 10	0.2 - 6	1.2	M6	6
0.2 - 10	0.2 - 6	1.2	M6	6
0.2 - 10	0.2 - 6	1.2	M6	6
0.2 - 10	0.2 - 6	1.2	M6	6
0.2 - 10	0.2 - 6	1.2	M6	6
0.2 - 10	0.2 - 6	1.2	M6	6
0.5 - 16	0.5 - 10	1.8	M6	6
0.5 - 16	0.5 - 10	1.8	M6	6
4 - 25	6 - 35	4.5	M10	18
4 - 25	6 - 35	4.5	M10	18
10 - 50	10 - 50	4	M10	18
10 - 50	10 - 50	4	M10	18
35 - 95	35 - 95	20	M10	18
35 - 95	35 - 95	20	M10	18

### TYPICAL ATTENUATION

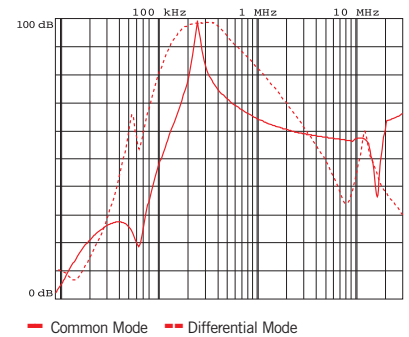

### MECHANICAL DIMENSIONS mm

FIN1700E	A	B	V	V1	F	H	I	L	N	d	Weight Kg.	Case
.007.M	140	50	19	15	6	226	200	7	28	M6	1.7	1
.013.M	140	50	19	15	6	226	200	7	28	M6	1.7	1
.018.M	140	50	19	15	6	226	200	7	28	M6	1.7	1
.027.M	140	50	19	15	6	226	200	7	28	M6	1.7	1
.034.M	140	50	19	15	6	226	200	7	28	M6	1.7	1
.040.M	140	50	19	15	6	226	200	7	28	M6	1.7	1
.055.M	177	70	19	25	6	295	265	8	44	M6	3.7	1
.070.M	177	70	19	33	6	295	265	8	44	M6	5.2	1
.100.M	205	80	28.5	38	8	390	340	12	53	M10	6.5	1
.110.M	205	80	28.5	38	8	390	340	12	53	M10	6.5	1
.130.M	205	80	28.5	43	8	390	340	12	53	M10	7.1	1
.150.M	205	80	28.5	43	8	390	340	12	53	M10	7.1	1
.200.M	220	105	28.5	50	8	420	370	12	78	M10	8	1
.230.M	220	105	28.5	50	8	420	370	12	78	M10	8	1

### CASE 1

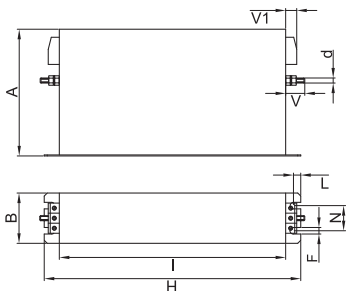

### ASSEMBLY CONNECTION "M"

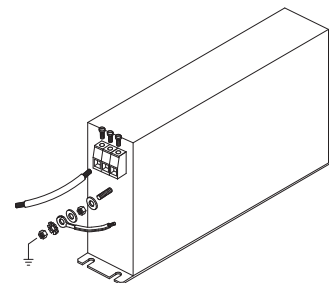



### EMI/RFI Filter with very high attenuation for industrial applications

Datasheet 3/2019



**FIN1700EG.(007 – 230).M**

#### FEATURES

- Rated current from 7 to 230A
- Very high differential and common mode attenuation
- Very low leakage current
- High attenuation in the low frequency range 100 kHz – 2 MHz

#### MARKETS

- Packaging machinery
- Printing machinery
- Variable frequency drives / servo drives
- Medical equipment

#### APPROVALS:

**UL** US E215863  
UL1283  
CSA C22.2

**RoHS**



**SCCR** by UL508A

#### BENEFITS

- 5 Year warranty
- Safety terminal block connector
- Very compact design

#### ORDERING CODE

FIN1700EG .070 .M  
Model Current (A) Connection  
M = Terminal block

#### ATTENUATION INDICATOR

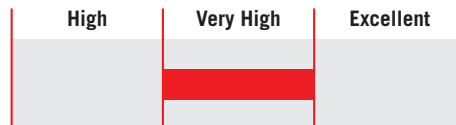

#### ELECTRIC DIAGRAM

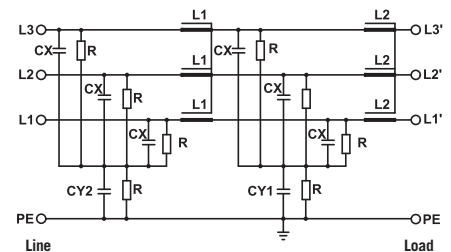

#### TECHNICAL SPECIFICATIONS

Nominal voltage	0 / 500 Vac
Frequency	50 – 60 Hz
Rated current	7 to 230A
Potential test voltage phase to phase	2300 Vdc (2 sec.)
Potential test voltage phase to ground	3100 Vdc (2 sec.)
Leakage current normal conditions	< 3 mA *
Leakage current worst conditions	< 15 mA
IP Protection	IP20
Overload capability	4 x Rated current (Switch ON) 2 x In 10 seconds 1.5 In for 10 minutes
Climatic class	-40 / +85° C
MTBF at 40°C	250.000 Hrs

\* Voltage 230 Vac phase to ground 50 Hz / 40°C

### ELECTRICAL CHARACTERISTICS

FIN1700EG	Rated Current 40°C	Rated Current 50°C	Power Loss (W)
.007.M	7	6	8
.013.M	13	12	12
.018.M	18	16	15
.027.M	27	25	20
.034.M	34	32	32
.040.M	40	36	23
.055.M	55	50	42
.070.M	70	64	55
.100.M	100	90	60
.110.M	110	100	90
.130.M	130	120	98
.150.M	150	135	103
.200.M	200	180	115
.230.M	230	210	120

### CONNECTIONS

LINE			PE	
Solid Cable (mm <sup>2</sup> )	Stranded Cable (mm <sup>2</sup> )	Terminal Torque (Nm)	d (mm)	Torque (Nm)
0.2 - 10	0.2 - 6	1.2	M6	6
0.2 - 10	0.2 - 6	1.2	M6	6
0.2 - 10	0.2 - 6	1.2	M6	6
0.2 - 10	0.2 - 6	1.2	M6	6
0.2 - 10	0.2 - 6	1.2	M6	6
0.2 - 10	0.2 - 6	1.2	M6	6
0.5 - 16	0.5 - 10	1.8	M6	6
0.5 - 16	0.5 - 10	1.8	M6	6
4 - 25	6 - 35	4.5	M10	18
4 - 25	6 - 35	4.5	M10	18
10 - 50	10 - 50	4	M10	18
10 - 50	10 - 50	4	M10	18
35 - 95	35 - 95	20	M10	18
35 - 95	35 - 95	20	M10	18

### TYPICAL ATTENUATION

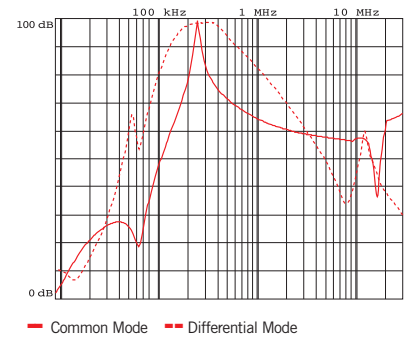

### MECHANICAL DIMENSIONS mm

FIN1700EG	A	B	V	V1	F	H	I	L	N	d	Weight Kg.	Case
.007.M	140	50	19	15	6	226	200	7	28	M6	1.7	1
.013.M	140	50	19	15	6	226	200	7	28	M6	1.7	1
.018.M	140	50	19	15	6	226	200	7	28	M6	1.7	1
.027.M	140	50	19	15	6	226	200	7	28	M6	1.7	1
.034.M	140	50	19	15	6	226	200	7	28	M6	1.7	1
.040.M	140	50	19	15	6	226	200	7	28	M6	1.7	1
.055.M	177	70	19	25	6	295	265	8	44	M6	3.7	1
.070.M	177	70	19	33	6	295	265	8	44	M6	5.2	1
.100.M	205	80	28.5	38	8	390	340	12	53	M10	6.5	1
.110.M	205	80	28.5	38	8	390	340	12	53	M10	6.5	1
.130.M	205	80	28.5	43	8	390	340	12	53	M10	7.1	1
.150.M	205	80	28.5	43	8	390	340	12	53	M10	7.1	1
.200.M	220	105	28.5	50	8	420	370	12	78	M10	8	1
.230.M	220	105	28.5	50	8	420	370	12	78	M10	8	1

### CASE 1

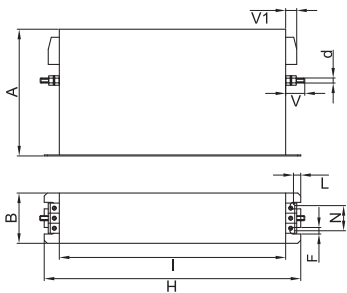

### ASSEMBLY CONNECTION "M"

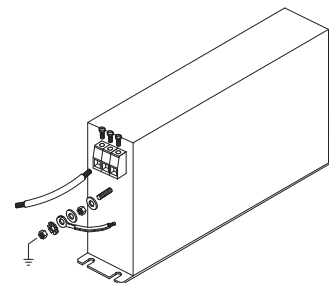



### EMI/RFI Filter with very high attenuation for IT network applications

Datasheet 3/2019

#### APPROVALS:



**FIN1700IT.(006 - 200).M**

#### FEATURES

- Rated current from 6 to 200A
- Very high differential and common mode attenuation
- Very low leakage current
- Designed for IT networks

#### BENEFITS

- 5 Year warranty
- Safety terminal block connector
- Available up to 2500A

#### MARKETS

- IT networks
- Semiconductor machinery

#### ORDERING CODE

FIN1700IT .055 .M  
 Model Current (A) Connection  
 M = Terminal block

Models available with current ratings up to 2500A

#### ATTENUATION INDICATOR

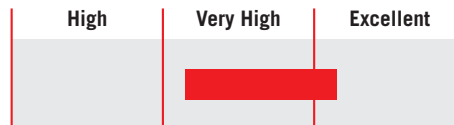

#### ELECTRIC DIAGRAM

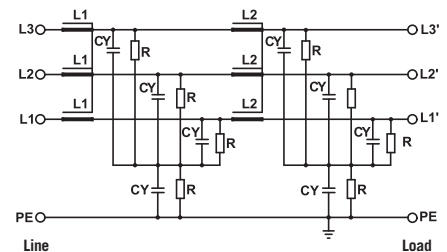

#### TECHNICAL SPECIFICATIONS

Nominal voltage	0 / 600 Vac
Frequency	50 – 60 Hz
Rated current	6 to 200A
Potential test voltage phase to phase	2700 Vdc (2 sec.)
Potential test voltage phase to ground	3200 Vdc (2 sec.)
Leakage current normal conditions	< 1 mA *
Leakage current worst conditions	< 3 mA
IP Protection	IP20 up to 200A
Overload capability	4 x Rated current (Switch ON) 2 x In 10 seconds 1.5 In for 10 minutes
Climatic class	-40 / +85° C
MTBF at 40°C	250.000 Hrs

\* Voltage 230 Vac phase to ground 50 Hz / 40°C

### ELECTRICAL CHARACTERISTICS

FIN1700IT	Rated Current 40°C	Rated Current 50°C	Power Loss (W)
.006.M	8	6	8
.012.M	14	12	10
.016.M	18	16	12
.025.M	28	25	15
.032.M	35	32	23
.042.M	50	42	32
.055.M	63	55	37
.070.M	80	70	52
.080.M	90	80	60
.100.M	110	100	92
.115.M	130	115	101
.150.M	175	150	115
.200.M	230	200	120

### CONNECTIONS

LINE			PE	
Solid Cable (mm <sup>2</sup> )	Stranded Cable (mm <sup>2</sup> )	Terminal Torque (Nm)	d (mm)	Torque (Nm)
0.2 - 10	0.2 - 6	1.2	M6	6
0.2 - 10	0.2 - 6	1.2	M6	6
0.2 - 10	0.2 - 6	1.2	M6	6
0.2 - 10	0.2 - 6	1.2	M6	6
0.2 - 10	0.2 - 6	1.2	M6	6
0.5 - 16	0.5 - 10	1.8	M6	6
0.5 - 16	0.5 - 10	1.8	M6	6
4 - 25	6 - 35	4.5	M10	18
4 - 25	6 - 35	4.5	M10	18
10 - 50	10 - 50	4	M10	18
10 - 50	10 - 50	4	M10	18
35 - 95	35 - 95	20	M10	18
35 - 95	35 - 95	20	M10	18

### TYPICAL ATTENUATION

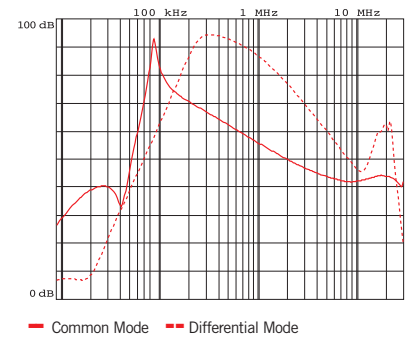

### MECHANICAL DIMENSIONS mm

FIN1700IT	A	B	V	V1	F	H	I	L	N	d	Weight Kg.	Case
.006.M	140	50	19	15	6	226	200	7	28	M6	1.7	1
.012.M	140	50	19	15	6	226	200	7	28	M6	1.7	1
.016.M	177	60	19	15	6	267	237	8	34	M6	1.7	1
.025.M	177	60	19	15	6	267	237	8	34	M6	2.3	1
.032.M	177	60	19	15	6	267	237	8	34	M6	2.3	1
.042.M	177	70	19	25	6	295	265	8	44	M6	3.4	1
.055.M	177	70	19	33	6	295	265	8	44	M6	3.5	1
.070.M	205	80	28	38	8	390	340	12	53	M10	6	1
.080.M	205	80	28	38	8	390	340	12	53	M10	6	1
.100.M	205	80	28	43	8	390	340	12	53	M10	7.1	1
.115.M	205	80	28	43	8	390	340	12	53	M10	7.1	1
.150.M	220	105	28	50	8	420	370	12	78	M10	8.5	1
.200.M	220	105	28	50	8	420	370	12	78	M10	8.5	1

### CASE 1

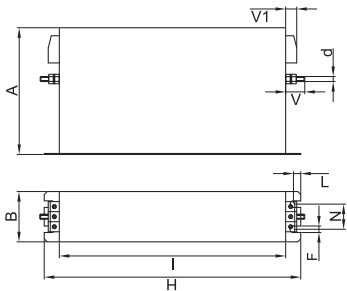

### ASSEMBLY CONNECTION "M"

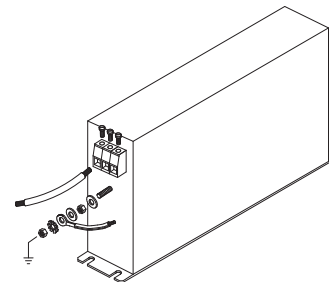



### EMI/RFI Filter with excellent attenuation for industrial applications

Datasheet 3/2019



**FIN1900.(006 – 200).M**

#### FEATURES

- Rated current from 6 to 200A
- Excellent differential and common mode attenuation
- Low leakage current

#### MARKETS

- Machine tools
- Packaging machinery
- Semiconductor machinery
- Processing machinery

#### APPROVALS:

UL1283  
CSA C22.2  
E215863

RoHS



SCCR by UL508A

#### BENEFITS

- 5 Year warranty
- Safety terminal block connector
- Helps pass immunity and emission tests for the IEC61000-6-2 and IEC61000-6-4 Standards

#### ORDERING CODE

FIN1900 .055 .M  
Model Current (A) Connection  
M = Terminal block

#### ATTENUATION INDICATOR

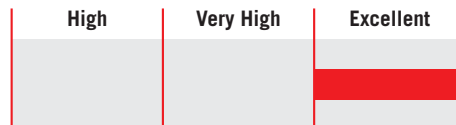

#### ELECTRIC DIAGRAM

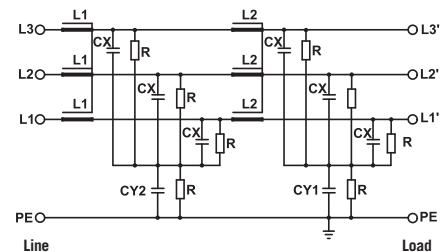

#### TECHNICAL SPECIFICATIONS

Nominal voltage	0 / 600 Vac
Frequency	50 – 60 Hz
Rated current	6 to 200A
Potential test voltage phase to phase	2400 Vdc (2 sec.)
Potential test voltage phase to ground	3200 Vdc (2 sec.)
Leakage current normal conditions	< 10 mA *
Leakage current worst conditions	< 80 mA
IP Protection	IP20
Overload capability	4 x Rated current (Switch ON) 2 x In 10 seconds 1.5 In for 10 minutes
Climatic class	-40 / +85° C
MTBF at 40°C	250.000 Hrs

\* Voltage 230 Vac phase to ground 50 Hz / 40°C



### ELECTRICAL CHARACTERISTICS

FIN 1900	Rated Current 40°C	Rated Current 50°C	Power Loss (W)
.006.M	8	6	8
.012.M	14	12	10
.016.M	18	16	12
.025.M	28	25	15
.032.M	35	32	23
.042.M	50	42	32
.055.M	63	55	37
.070.M	80	70	52
.080.M	90	80	60
.100.M	110	100	92
.115.M	130	115	101
.150.M	175	150	115
.200.M	230	200	120

### CONNECTIONS

LINE			PE	
Solid Cable (mm <sup>2</sup> )	Stranded Cable (mm <sup>2</sup> )	Terminal Torque (Nm)	d (mm)	Torque (Nm)
0.2 - 10	0.2 - 6	1.2	M6	6
0.2 - 10	0.2 - 6	1.2	M6	6
0.2 - 10	0.2 - 6	1.2	M6	6
0.2 - 10	0.2 - 6	1.2	M6	6
0.2 - 10	0.2 - 6	1.2	M6	6
0.5 - 16	0.5 - 10	1.8	M6	6
0.5 - 16	0.5 - 10	1.8	M6	6
4 - 25	6 - 35	4.5	M10	18
4 - 25	6 - 35	4.5	M10	18
10 - 50	10 - 50	4	M10	18
10 - 50	10 - 50	4	M10	18
35 - 95	35 - 95	20	M10	18
35 - 95	35 - 95	20	M10	18

### TYPICAL ATTENUATION

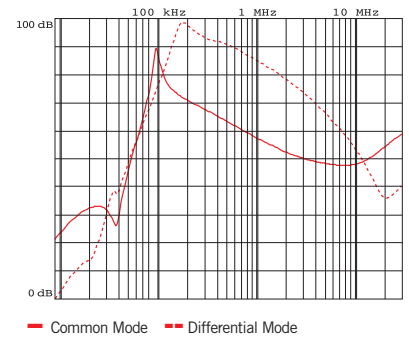

### MECHANICAL DIMENSIONS mm

FIN 1900	A	B	V	V1	F	H	I	L	N	d	Weight Kg.	Case
.006.M	140	50	19	15	6	226	200	7	28	M6	1.7	1
.012.M	140	50	19	15	6	226	200	7	28	M6	1.7	1
.016.M	177	60	19	15	6	267	237	8	34	M6	1.7	1
.025.M	177	60	19	15	6	267	237	8	34	M6	2.3	1
.032.M	177	60	19	15	6	267	237	8	34	M6	2.3	1
.042.M	177	70	19	25	6	295	265	8	44	M6	3.4	1
.055.M	177	70	19	33	6	295	265	8	44	M6	3.5	1
.070.M	205	80	28	38	8	390	340	12	53	M10	6	1
.080.M	205	80	28	38	8	390	340	12	53	M10	6	1
.100.M	205	80	28	43	8	390	340	12	53	M10	7.1	1
.115.M	205	80	28	43	8	390	340	12	53	M10	7.1	1
.150.M	220	105	28	50	8	420	370	12	78	M10	8.5	1
.200.M	220	105	28	50	8	420	370	12	78	M10	8.5	1

### CASE 1

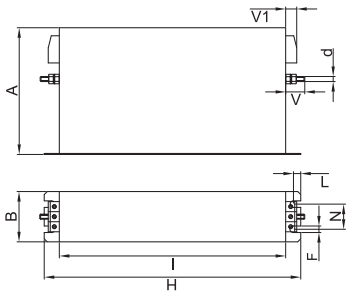

### ASSEMBLY CONNECTION "M"

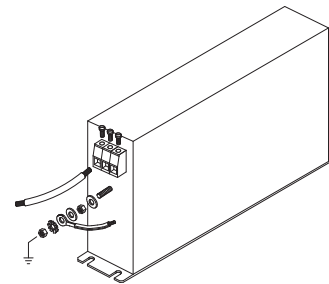



### EMI/RFI Filter with excellent attenuation for industrial applications

Datasheet 3/2019



**FIN1900G.(006 – 200).M**

#### FEATURES

- Rated current from 6 to 200A
- Excellent differential and common mode attenuation
- Low leakage current
- High attenuation in the low frequency range 100 kHz – 2 MHz

#### MARKETS

- Machine tools
- Packaging machinery
- Semiconductor machinery
- Processing machinery

#### APPROVALS:

UL1283  
CSA C22.2  
E215863

RoHS



SCCR by UL508A

#### BENEFITS

- 5 Year warranty
- Safety terminal block connector
- Helps pass immunity and emission tests for the IEC61000-6-2 and IEC61000-6-4 Standards

#### ORDERING CODE

FIN1900G .055 .M  
Model Current (A) Connection  
M = Terminal block

#### ATTENUATION INDICATOR

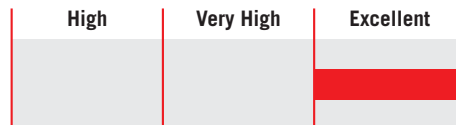

#### ELECTRIC DIAGRAM

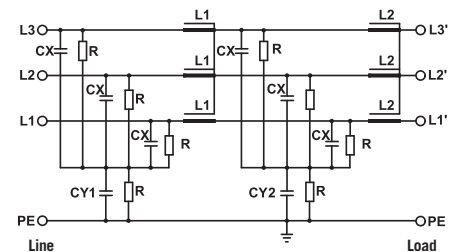

#### TECHNICAL SPECIFICATIONS

Nominal voltage	0 / 600 Vac
Frequency	50 – 60 Hz
Rated current	6 to 200A
Potential test voltage phase to phase	2400 Vdc (2 sec.)
Potential test voltage phase to ground	3200 Vdc (2 sec.)
Leakage current normal conditions	< 10 mA *
Leakage current worst conditions	< 80 mA
IP Protection	IP20
Overload capability	4 x Rated current (Switch ON) 2 x In 10 seconds 1.5 In for 10 minutes
Climatic class	-40 / +85° C
MTBF at 40°C	250.000 Hrs

\* Voltage 230 Vac phase to ground 50 Hz / 40°C

### ELECTRICAL CHARACTERISTICS

FIN1900G	Rated Current 40°C	Rated Current 50°C	Power Loss (W)
.006.M	8	6	8
.012.M	14	12	10
.016.M	18	16	12
.025.M	28	25	15
.032.M	35	32	23
.042.M	50	42	32
.055.M	63	55	37
.070.M	80	70	52
.080.M	90	80	60
.100.M	110	100	92
.115.M	130	115	101
.150.M	175	150	115
.200.M	230	200	120

### CONNECTIONS

LINE			PE	
Solid Cable (mm <sup>2</sup> )	Stranded Cable (mm <sup>2</sup> )	Terminal Torque (Nm)	d (mm)	Torque (Nm)
0.2 - 10	0.2 - 6	1.2	M6	6
0.2 - 10	0.2 - 6	1.2	M6	6
0.2 - 10	0.2 - 6	1.2	M6	6
0.2 - 10	0.2 - 6	1.2	M6	6
0.2 - 10	0.2 - 6	1.2	M6	6
0.5 - 16	0.5 - 10	1.8	M6	6
0.5 - 16	0.5 - 10	1.8	M6	6
4 - 25	6 - 35	4.5	M10	18
4 - 25	6 - 35	4.5	M10	18
10 - 50	10 - 50	4	M10	18
10 - 50	10 - 50	4	M10	18
35 - 95	35 - 95	20	M10	18
35 - 95	35 - 95	20	M10	18

### TYPICAL ATTENUATION

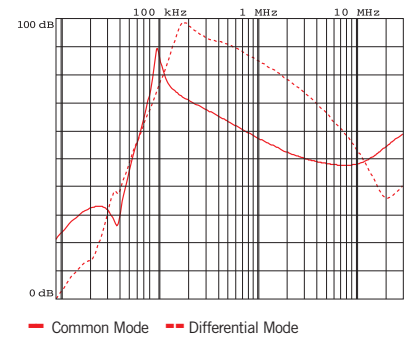

### MECHANICAL DIMENSIONS mm

FIN1900G	A	B	V	V1	F	H	I	L	N	d	Weight Kg.	Case
.006.M	140	50	19	15	6	226	200	7	28	M6	1.7	1
.012.M	140	50	19	15	6	226	200	7	28	M6	1.7	1
.016.M	177	60	19	15	6	267	237	8	34	M6	1.7	1
.025.M	177	60	19	15	6	267	237	8	34	M6	2.3	1
.032.M	177	60	19	15	6	267	237	8	34	M6	2.3	1
.042.M	177	70	19	25	6	295	265	8	44	M6	3.4	1
.055.M	177	70	19	33	6	295	265	8	44	M6	3.5	1
.070.M	205	80	28	38	8	390	340	12	53	M10	6	1
.080.M	205	80	28	38	8	390	340	12	53	M10	6	1
.100.M	205	80	28	43	8	390	340	12	53	M10	7.1	1
.115.M	205	80	28	43	8	390	340	12	53	M10	7.1	1
.150.M	220	105	28	50	8	420	370	12	78	M10	8.5	1
.200.M	220	105	28	50	8	420	370	12	78	M10	8.5	1

### CASE 1

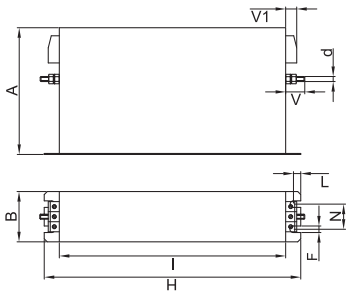

### ASSEMBLY CONNECTION "M"

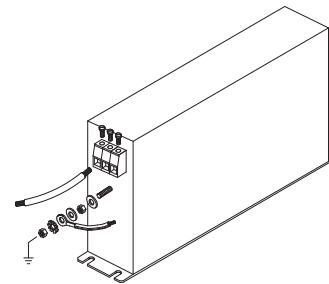



### EMI/RFI Filter with excellent attenuation for industrial applications

Datasheet 3/2019



**FIN1900E.(007 – 230).M**

#### FEATURES

- Rated current from 7 to 230A
- Excellent differential and common mode attenuation
- Low leakage current

#### MARKETS

- Machine tools
- Laser machinery
- Recharging stations
- Uninterruptible power supplies

#### APPROVALS:

UL1283  
CSA C22.2  
E215863

RoHS



SCCR by UL508A

#### BENEFITS

- 5 Year warranty
- Safety terminal block connector
- High performance in a compact design

#### ORDERING CODE

FIN1900E .070 .M  
Model Current (A) Connection  
M = Terminal block

#### ATTENUATION INDICATOR



#### ELECTRIC DIAGRAM

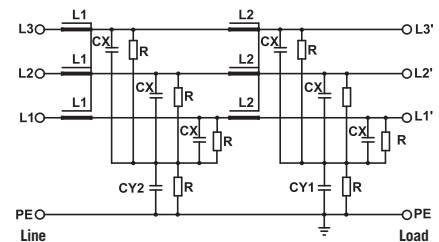

#### TECHNICAL SPECIFICATIONS

Nominal voltage	0 / 500 Vac
Frequency	50 – 60 Hz
Rated current	7 to 230A
Potential test voltage phase to phase	2300 Vdc (2 sec.)
Potential test voltage phase to ground	3100 Vdc (2 sec.)
Leakage current normal conditions	< 10 mA *
Leakage current worst conditions	< 80 mA
IP Protection	IP20
Overload capability	4 x Rated current (Switch ON) 2 x In 10 seconds 1.5 In for 10 minutes
Climatic class	-40 / +85° C
MTBF at 40°C	250.000 Hrs

\* Voltage 230 Vac phase to ground 50 Hz / 40°C

### ELECTRICAL CHARACTERISTICS

FIN1900E	Rated Current 40°C	Rated Current 50°C	Power Loss (W)
.007.M	7	6	8
.013.M	13	12	12
.018.M	18	16	15
.027.M	27	25	20
.034.M	34	32	32
.040.M	40	36	23
.055.M	55	50	42
.070.M	70	64	55
.100.M	100	90	60
.110.M	110	100	90
.130.M	130	120	98
.150.M	150	135	103
.200.M	200	180	115
.230.M	230	210	120

### CONNECTIONS

LINE			PE	
Solid Cable (mm <sup>2</sup> )	Stranded Cable (mm <sup>2</sup> )	Terminal Torque (Nm)	d (mm)	Torque (Nm)
0.2 - 10	0.2 - 6	1.2	M6	6
0.2 - 10	0.2 - 6	1.2	M6	6
0.2 - 10	0.2 - 6	1.2	M6	6
0.2 - 10	0.2 - 6	1.2	M6	6
0.2 - 10	0.2 - 6	1.2	M6	6
0.2 - 10	0.2 - 6	1.2	M6	6
0.5 - 16	0.5 - 10	1.8	M6	6
0.5 - 16	0.5 - 10	1.8	M6	6
4 - 25	6 - 35	4.5	M10	18
4 - 25	6 - 35	4.5	M10	18
10 - 50	10 - 50	4	M10	18
10 - 50	10 - 50	4	M10	18
35 - 95	35 - 95	20	M10	18
35 - 95	35 - 95	20	M10	18

### TYPICAL ATTENUATION

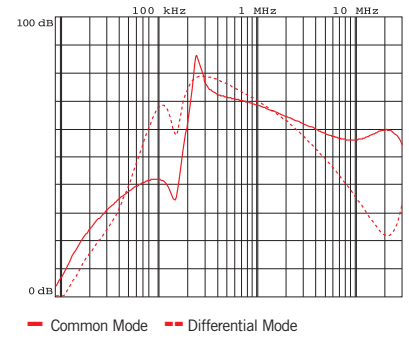

### MECHANICAL DIMENSIONS mm

FIN1900E	A	B	V	V1	F	H	I	L	N	d	Weight Kg.	Case
.007.M	140	50	19	15	6	226	200	7	28	M6	1.7	1
.013.M	140	50	19	15	6	226	200	7	28	M6	1.7	1
.018.M	140	50	19	15	6	226	200	7	28	M6	1.7	1
.027.M	140	50	19	15	6	226	200	7	28	M6	1.7	1
.034.M	140	50	19	15	6	226	200	7	28	M6	1.7	1
.040.M	140	50	19	15	6	226	200	7	28	M6	1.7	1
.055.M	177	70	19	25	6	295	265	8	44	M6	3.7	1
.070.M	177	70	19	33	6	295	265	8	44	M6	5.2	1
.100.M	205	80	28.5	38	8	390	340	12	53	M10	6.5	1
.110.M	205	80	28.5	38	8	390	340	12	53	M10	6.5	1
.130.M	205	80	28.5	43	8	390	340	12	53	M10	7.1	1
.150.M	205	80	28.5	43	8	390	340	12	53	M10	7.1	1
.200.M	220	105	28.5	50	8	420	370	12	78	M10	8	1
.230.M	220	105	28.5	50	8	420	370	12	78	M10	8	1

### CASE 1

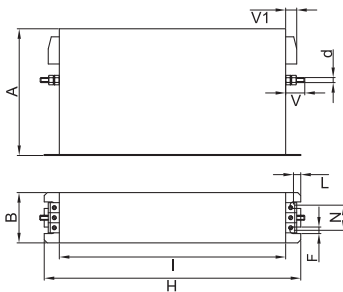

### ASSEMBLY CONNECTION "M"

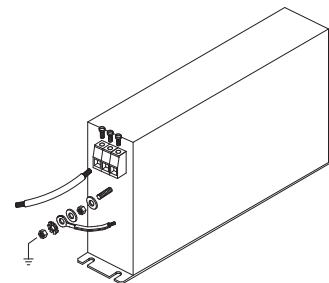



### EMI/RFI Filter with excellent attenuation for industrial applications

Datasheet 3/2019



**FIN1900EG.(007 – 230).M**

#### FEATURES

- Rated current from 7 to 230A
- Excellent differential and common mode attenuation
- Low leakage current
- High attenuation in the low frequency range 100 kHz – 2 MHz

#### MARKETS

- Machine tools
- Laser machinery
- Recharging stations
- Uninterruptible power supplies

#### APPROVALS:

UL1283  
CSA C22.2  
E215863

RoHS



SCCR by UL508A

#### BENEFITS

- 5 Year warranty
- Safety terminal block connector
- High performance in a compact design

#### ORDERING CODE

FIN1900EG .070 .M  
Model Current (A) Connection  
M = Terminal block

#### ATTENUATION INDICATOR



#### ELECTRIC DIAGRAM

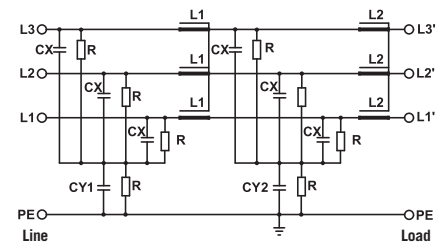

#### TECHNICAL SPECIFICATIONS

Nominal voltage	0 / 500 Vac
Frequency	50 – 60 Hz
Rated current	7 to 230A
Potential test voltage phase to phase	2300 Vdc (2 sec.)
Potential test voltage phase to ground	3100 Vdc (2 sec.)
Leakage current normal conditions	< 10 mA *
Leakage current worst conditions	< 80 mA
IP Protection	IP20
Overload capability	4 x Rated current (Switch ON) 2 x In 10 seconds 1.5 In for 10 minutes
Climatic class	-40 / +85° C
MTBF at 40°C	250.000 Hrs

\* Voltage 230 Vac phase to ground 50 Hz / 40°C

### ELECTRICAL CHARACTERISTICS

FIN1900EG	Rated Current 40°C	Rated Current 50°C	Power Loss (W)
.007.M	7	6	8
.013.M	13	12	12
.018.M	18	16	15
.027.M	27	25	20
.034.M	34	32	32
.040.M	40	36	23
.055.M	55	50	42
.070.M	70	64	55
.100.M	100	90	60
.110.M	110	100	90
.130.M	130	120	98
.150.M	150	135	103
.200.M	200	180	115
.230.M	230	210	120

### CONNECTIONS

LINE			PE	
Solid Cable (mm <sup>2</sup> )	Stranded Cable (mm <sup>2</sup> )	Terminal Torque (Nm)	d (mm)	Torque (Nm)
0.2 - 10	0.2 - 6	1.2	M6	6
0.2 - 10	0.2 - 6	1.2	M6	6
0.2 - 10	0.2 - 6	1.2	M6	6
0.2 - 10	0.2 - 6	1.2	M6	6
0.2 - 10	0.2 - 6	1.2	M6	6
0.2 - 10	0.2 - 6	1.2	M6	6
0.5 - 16	0.5 - 10	1.8	M6	6
0.5 - 16	0.5 - 10	1.8	M6	6
4 - 25	6 - 35	4.5	M10	18
4 - 25	6 - 35	4.5	M10	18
10 - 50	10 - 50	4	M10	18
10 - 50	10 - 50	4	M10	18
35 - 95	35 - 95	20	M10	18
35 - 95	35 - 95	20	M10	18

### TYPICAL ATTENUATION

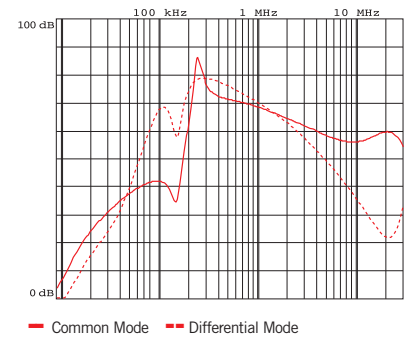

### MECHANICAL DIMENSIONS mm

FIN1900EG	A	B	V	V1	F	H	I	L	N	d	Weight Kg.	Case
.007.M	140	50	19	15	6	226	200	7	28	M6	1.7	1
.013.M	140	50	19	15	6	226	200	7	28	M6	1.7	1
.018.M	140	50	19	15	6	226	200	7	28	M6	1.7	1
.027.M	140	50	19	15	6	226	200	7	28	M6	1.7	1
.034.M	140	50	19	15	6	226	200	7	28	M6	1.7	1
.040.M	140	50	19	15	6	226	200	7	28	M6	1.7	1
.055.M	177	70	19	25	6	295	265	8	44	M6	3.7	1
.070.M	177	70	19	33	6	295	265	8	44	M6	5.2	1
.100.M	205	80	28.5	38	8	390	340	12	53	M10	6.5	1
.110.M	205	80	28.5	38	8	390	340	12	53	M10	6.5	1
.130.M	205	80	28.5	43	8	390	340	12	53	M10	7.1	1
.150.M	205	80	28.5	43	8	390	340	12	53	M10	7.1	1
.200.M	220	105	28.5	50	8	420	370	12	78	M10	8	1
.230.M	220	105	28.5	50	8	420	370	12	78	M10	8	1

### CASE 1

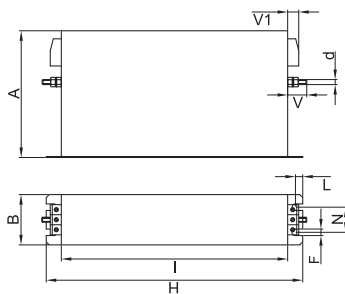

### ASSEMBLY CONNECTION "M"

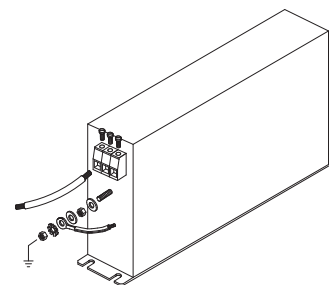





### EMI/RFI Filter with excellent attenuation for industrial applications

Datasheet 3/2019



**FIN1900S.(042 – 200).M**

#### FEATURES

- Rated current from 42 to 200A
- Excellent differential and common mode attenuation
- Low leakage current

#### MARKETS

- CNC machinery
- Multiple axis applications
- Recharging stations
- Welding systems

#### APPROVALS:

UL1283  
CSA C22.2  
E215863



**SCCR** by UL508A

#### BENEFITS

- 5 Year warranty
- Safety terminal block connector
- Helps pass immunity and emission tests for the IEC61000-6-2 and IEC61000-6-4 Standards

#### ORDERING CODE

FIN1900S	.055	.M
Model	Current (A)	Connection
		M = Terminal block

#### ATTENUATION INDICATOR

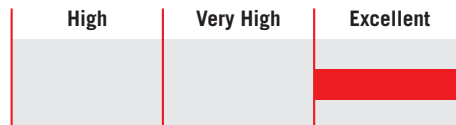

#### ELECTRIC DIAGRAM

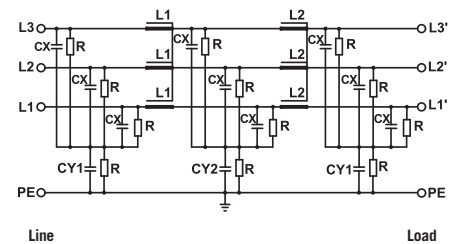

#### TECHNICAL SPECIFICATIONS

Nominal voltage	0 / 600 Vac
Frequency	50 – 60 Hz
Rated current	42 to 200A
Potential test voltage phase to phase	2400 Vdc (2 sec.)
Potential test voltage phase to ground	3200 Vdc (2 sec.)
Leakage current normal conditions	< 15 mA *
Leakage current worst conditions	< 150 mA
IP Protection	IP20
Overload capability	4 x Rated current (Switch ON) 2 x In 10 seconds 1.5 In for 10 minutes
Climatic class	-40 / +85° C
MTBF at 40°C	250.000 Hrs

\* Voltage 230 Vac phase to ground 50 Hz / 40°C

### ELECTRICAL CHARACTERISTICS

FIN1900S	Rated Current 40°C	Rated Current 50°C	Power Loss (W)
.042.M	50	42	32
.055.M	63	55	37
.070.M	80	70	52
.080.M	90	80	60
.100.M	110	100	92
.115.M	130	115	101
.150.M	175	150	115
.200.M	230	200	120

### CONNECTIONS

LINE			PE	
Solid Cable (mm <sup>2</sup> )	Stranded Cable (mm <sup>2</sup> )	Terminal Torque (Nm)	d (mm)	Torque (Nm)
0.5 - 16	0.5 - 10	1.8	M6	6
0.5 - 16	0.5 - 10	1.8	M6	6
4 - 25	6 - 35	4.5	M10	18
4 - 25	6 - 35	4.5	M10	18
10 - 50	10 - 50	4	M10	18
10 - 50	10 - 50	4	M10	18
35 - 95	35 - 95	20	M10	18
35 - 95	35 - 95	20	M10	18

### TYPICAL ATTENUATION

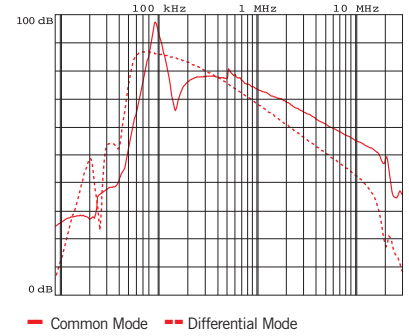

### MECHANICAL DIMENSIONS mm

FIN1900S	A	B	V	V1	F	H	I	L	N	d	Weight Kg.	Case
.042.M	177	70	19	25	6	295	265	8	44	M6	3.4	1
.055.M	177	70	19	33	6	295	265	8	44	M6	3.5	1
.070.M	205	80	28	38	8	390	340	12	53	M10	6	1
.080.M	205	80	28	38	8	390	340	12	53	M10	6	1
.100.M	205	80	28	43	8	390	340	12	53	M10	7.1	1
.115.M	205	80	28	43	8	390	340	12	53	M10	7.1	1
.150.M	220	105	28	50	8	420	370	12	78	M10	8	1
.200.M	220	105	28	50	8	420	370	12	78	M10	8	1

### CASE 1

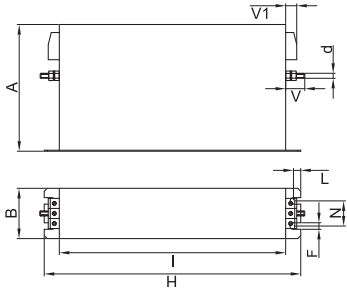

### ASSEMBLY CONNECTION "M"

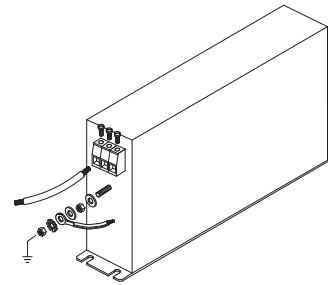



### EMI/RFI Filter with very high attenuation for industrial applications

Datasheet 3/2019

#### APPROVALS:



UL1283  
CSA C22.2



**FIN3755.(007 - 180).M**



**FIN3755.280.B**

#### FEATURES

- Rated current from 7 to 280A
- Very high differential and common mode attenuation
- Excellent performance and value

#### BENEFITS

- 5 Year warranty
- Safety terminal block connector
- Extremely compact design

#### MARKETS

- Variable frequency drives / servo drives
- Automated machinery
- Packaging machinery
- HVAC systems

#### ORDERING CODE

FIN3755	.055	.M
Model	Current (A)	Connection
		M = Terminal block
		B = bus bar

#### ATTENUATION INDICATOR

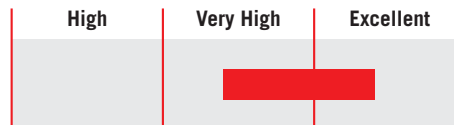

#### ELECTRIC DIAGRAM

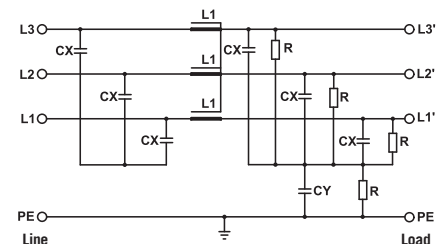

#### TECHNICAL SPECIFICATIONS

Nominal voltage	0 / 480 Vac
Frequency	50 – 60 Hz
Rated current	7 to 280A
Potential test voltage phase to phase	2200 Vdc (2 sec.)
Potential test voltage phase to ground	2900 Vdc (2 sec.)
Leakage current normal conditions	< 10 mA *
Leakage current worst conditions	< 80 mA
IP Protection	IP20 up to 180A IPO0 over 180A
Overload capability	4 x Rated current (Switch ON) 2 x In 10 seconds 1.5 In for 10 minutes
Climatic class	-40 / +85° C
MTBF at 40°C	250.000 Hrs

\* Voltage 230 Vac phase to ground 50 Hz / 40°C

### ELECTRICAL CHARACTERISTICS

FIN3755	Rated Current 40°C	Rated Current 50°C	Power Loss (W)
.007.M	8	7	3
.016.M	18	16	4
.030.M	32	30	11
.042.M	45	42	15
.055.M	58	55	19
.075.M	80	75	25
.100.M	105	100	42
.150.M	160	150	52
.180.M	190	180	61

FIN3755	Rated Current 40°C	Rated Current 50°C	Power Loss (W)
.280.B	280	250	75

### CONNECTIONS

LINE			PE	
Solid Cable (mm <sup>2</sup> )	Stranded Cable (mm <sup>2</sup> )	Terminal Torque (Nm)	d (mm)	Torque (Nm)
0.2 - 4	0.2 - 4	0.5	M5	4
0.2 - 4	0.2 - 4	0.5	M5	4
0.2 - 10	0.2 - 6	1.2	M6	6
0.2 - 10	0.2 - 6	1.2	M6	6
0.5 - 16	0.5 - 10	1.8	M6	6
4 - 25	6 - 35	4.5	M6	6
4 - 25	6 - 35	4.5	M10	18
10 - 50	10 - 50	20	M10	18
35 - 95	35 - 95	20	M10	18

LINE		PE	
d (mm)	Torque (Nm)	d 1 (Nm)	Torque (Nm)
M8	14	M8	14

### TYPICAL ATTENUATION

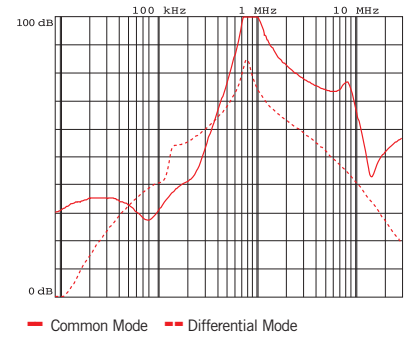

### MECHANICAL DIMENSIONS mm

FIN3755	A	B	C	D	E	F	G	d	I	Weight Kg.	Case
.007.M	160	180	190	78	48	20	4	M5	1	1.1	1
.016.M	220	235	250	85	48	25	5	M5	1	1.5	1
.030.M	240	255	270	85	50	30	5	M6	1	2.1	1
.042.M	280	295	310	85	50	30	5	M6	1	2.7	1
.055.M	220	235	250	100	90	60	5	M6	1	3.1	1
.075.M	240	255	270	135	85	60	5	M6	1.5	3.6	1
.100.M	240	255	270	155	90	65	6	M10	1.5	4.2	1
.150.M	300	315	330	156.5	90	65	6	M10	1.5	6	1
.180.M	350	365	380	170	125	102	6.5	M10	1.5	7.5	1

### CASE 1

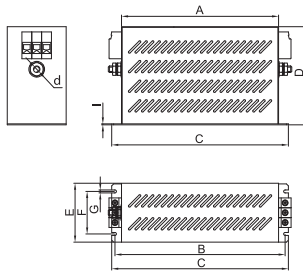

### ASSEMBLY CONNECTION "M"

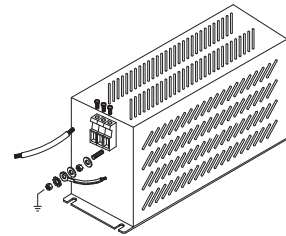

### FIN3755

FIN3755	A	B	C	D	E	H	I	L	N	P	S	d	d2	Weight Kg.	Case
.280.B	86	200	60	300	277	300	240	275	165	320	37	9	20x6	5.2	2

### CASE 2

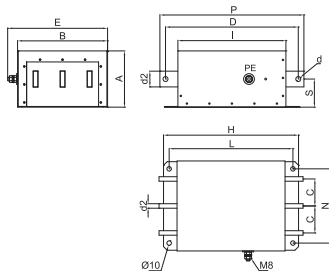

### ASSEMBLY CONNECTION "B"

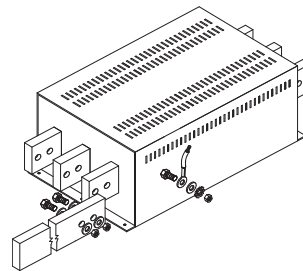



## EMI/RFI Filter with very high attenuation for industrial applications

Datasheet 3/2019

**APPROVALS:**

**FIN7213.(150 - 2000).B**

Models available with current ratings up to 3000A

**FEATURES**

- Rated current from 150 to 2000A
- Very high differential and common mode attenuation
- Low leakage current

**BENEFITS**

- 5 Year warranty
- Very compact design
- Finger safe protection available
- Zero volt insulated available

**MARKETS**

- Electrical equipment
- Machine tools
- Industrial automation
- Variable frequency drives / servo drives
- Regenerative systems
- Renewable energy

**ORDERING CODE**

FIN7213	.280	.B
Model	Current (A)	Connection
		B = Bus bar

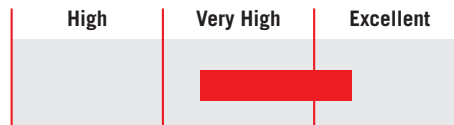
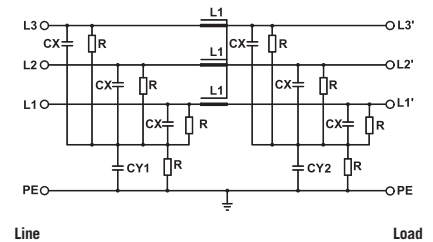
**ATTENUATION INDICATOR**

**ELECTRIC DIAGRAM**

**TECHNICAL SPECIFICATIONS**

	<b>FIN7213</b>
Nominal voltage	0 / 600 Vac
Frequency	50 – 60 Hz
Rated current	150 to 2000A
Potential test voltage phase to phase	2400 Vdc (2 sec.)
Potential test voltage phase to ground	3200 Vdc (2 sec.)
Leakage current normal conditions	<10 mA*
Leakage current worst conditions	< 35 mA
IP Protection	IPO0 over
Overload capability	4 x Rated current (Switch ON) 2 x In 10 seconds 1.5 In for 10 minutes
Climatic class	-40 / +85° C
MTBF at 40°C	250.000 Hrs

\* Voltage 230 Vac phase to ground 50Hz / 40°C

### ELECTRICAL CHARACTERISTICS

FIN7213	Rated Current 40°C	Rated Current 50°C	Power Loss (W)
.150.B	150	135	65
.200.B	200	180	70
.280.B	280	250	75
.320.B	320	290	80
.360.B	360	325	95
.400.B	400	360	110
.500.B	500	450	102
.600.B	600	540	95
.750.B	750	675	80
.800.B	800	720	82
.900.B	900	810	90
.1000.B	1000	900	100
.1250.B	1250	1120	105
.1500.B	1500	1350	110
.1750.B	1750	1500	125
.2000.B	2000	1750	132

### CONNECTIONS

LINE		PE	
d (mm)	Torque (Nm)	d1 (mm)	Torque (Nm)
M8	14	M8	14
M8	14	M8	14
M8	14	M8	14
M8	14	M8	14
M8	14	M8	14
M8	14	M8	14
M8	14	M8	14
M10	18	M8	14
M10	18	M8	14
M10	18	M8	14
M10	18	M8	14
M10	18	M8	14
M10	18	M8	14
M10	18	M8	14
M10	18	M8	14
M10	18	M8	14

### TYPICAL ATTENUATION

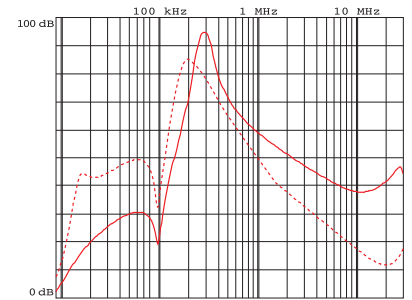

— Common Mode    - - - Differential Mode

Typical attenuation 150A - 2000A

**MECHANICAL DIMENSIONS mm**

FIN7213	A	B	C	D	E	H	I	L	N	P	S	d	d2	Weight Kg.	Case
.150.B	86	200	60	300	227	300	240	275	165	320	37	9	20x6	5	1
.200.B	86	200	60	300	227	300	240	275	165	320	37	9	20x6	5.1	1
.280.B	86	200	60	300	227	300	240	275	165	320	37	9	20x6	5.2	1
.320.B	86	200	60	300	227	300	240	275	165	320	37	9	20x6	5.2	1
.360.B	86	200	60	300	227	300	240	275	165	320	37	9	20x6	5.3	1
.400.B	86	200	60	300	227	300	240	275	165	320	37	9	20x6	5.3	1
.500.B	125	200	60	295	222	300	240	275	200	320	62.5	11	35x10	8.2	2
.600.B	125	200	60	295	222	300	240	275	200	320	62.5	11	35x10	8.4	2
.750.B	125	200	60	295	222	300	240	275	200	320	62.5	11	35x10	8.5	2

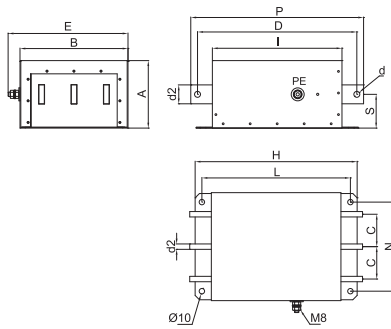
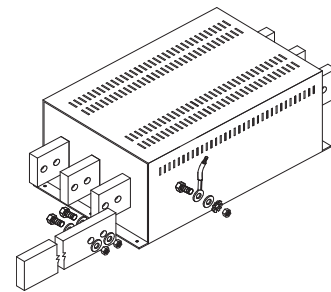
**CASE 1, 2**

**ASSEMBLY CONNECTION "B"**

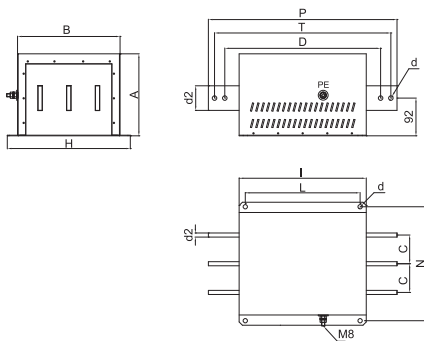
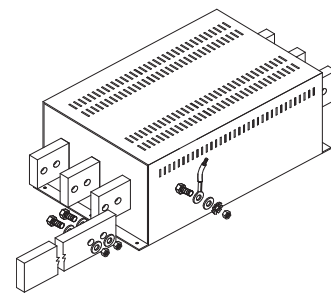
**MECHANICAL DIMENSIONS mm**

FIN7213	A	B	C	D	E	H	I	L	N	P	S	T	d	d2	Weight Kg.	Case
.800.B	200	250	70	380	277	300	310	280	278	460	-	430	11	50x10	8.4	3
.900.B	200	250	70	380	277	300	310	280	278	460	-	430	11	50x10	8.4	3
.1000.B	200	250	70	380	277	300	310	280	278	460	-	430	11	60x10	20.2	4
.1250.B	200	250	70	380	277	300	310	280	278	460	-	430	11	60x10	20.5	4

**CASE 3, 4**

**ASSEMBLY CONNECTION "B"**



### MECHANICAL DIMENSIONS mm

FIN7213	A	B	C	D	H	I	L	N	P	K	T	d	d2	Weight Kg.	Case
.1500.B	200	250	70	380	300	310	280	278	460	430	405	11	70x10	22	5
.1750.B	200	250	70	380	300	310	280	278	460	430	405	11	80x10	25	5
.2000.B	200	250	70	380	300	310	280	278	460	430	405	11	80x10	25	5

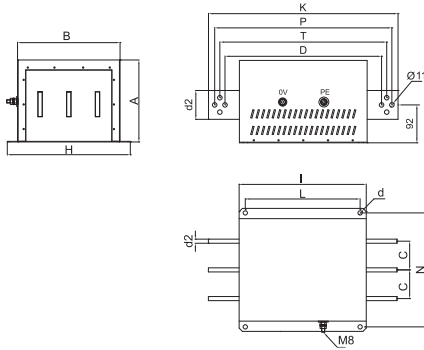
### CASE 5



### ASSEMBLY CONNECTION "B"

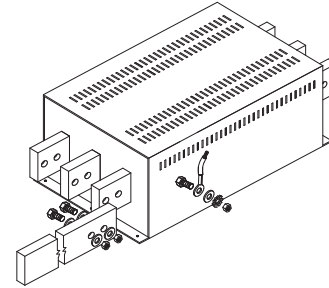

Filter Selection Guide	Description	Current Range (A)	Voltage	CONNECTORS			FEATURES						APPLICATIONS				Approval
				Terminal Blocks	Screws	Bus Bar	Regenerative Systems	DIN Rail Mount	Long Cable Applications	Low Frequency Attenuation	Book Case Style	Very Low Leakage Current	Multiple Drives	Automation	Renewable Energy	Medical	
<b>Three Phase + Neutral</b>																	
<b>FIN15</b>	3-phase plus neutral	3-20	0-480	X				X				X				X	UL US
<b>FIN1240</b>	3-phase plus neutral	5-2000	0-480	X	X	X	X		X	X		X	X		X		UL US
<b>FIN1740</b>	3-phase plus neutral	6-200	0-600	X			X		X		X	X		X			UL US
<b>FIN1740ESM</b>	3-phase plus neutral	10-180	0-500	X								X		X		X	UL US
<b>FIN1940</b>	3-phase plus neutral	6-200	0-600	X			X		X		X		X		X		UL US
<b>FIN1940E</b>	3-phase plus neutral	18-200	0-500	X						X		X	X		X		UL US

Enerdoor three phase plus neutral series provides high attenuation in a compact case with low leakage current and is suitable for a broad range of industries.

This series carries CE and UL approvals and offers a current range from 3 to 2000A with nominal voltage up to 600 Vac.

This line offers terminal block, screw and bus bar connectors. Features include: finger safe protection for screw and bus bar connections, and DIN rail mounting for fast and easy installation within the enclosure. Customized solutions are available to satisfy various application requirements.

**Three phase + neutral applications include:**

- Conveyors
- Packaging machinery
- Medical equipment
- 3D printers
- Semiconductor machinery
- Automated machinery
- Woodworking machinery
- Multiple drive applications
- Laser equipment
- CNC machinery

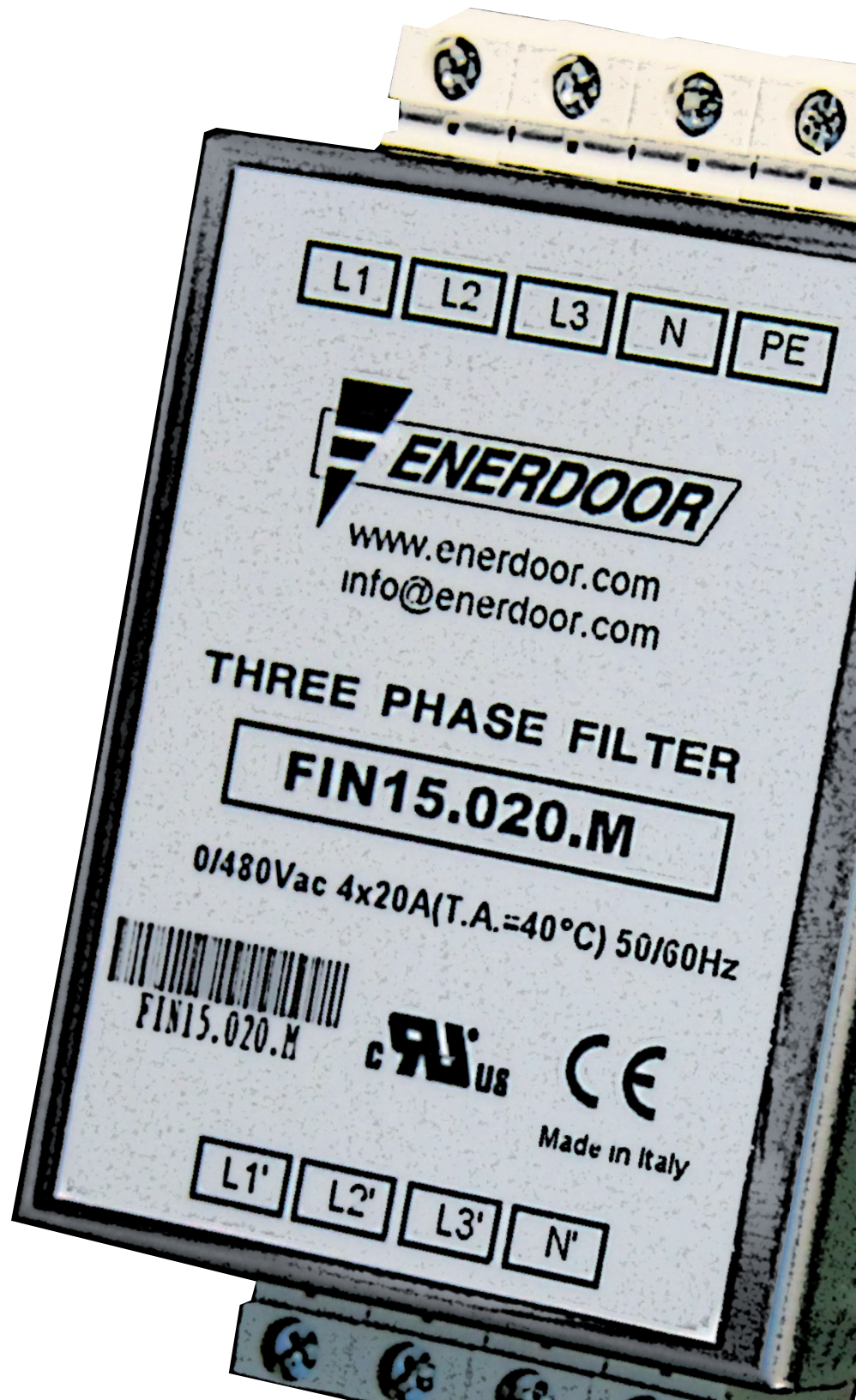



Datasheet 3/2019

### EMI/RFI Filter with high attenuation for industrial applications

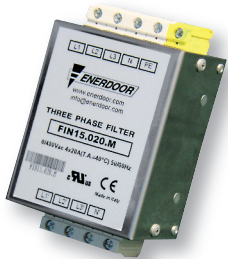

**FIN15.(003 - 020).M**

#### FEATURES

- Rated current from 3 to 20A
- High differential and common mode attenuation
- Very low leakage current
- DIN rail mounting

#### MARKETS

- Conveyors
- Packaging machinery
- Medical equipment
- 3D printers

#### APPROVALS:



UL1283  
CSA C22.2



**SCCR** by UL508A

#### BENEFITS

- 5 Year warranty
- Suitable for medical applications
- Compact design

#### ORDERING CODE

FIN15	.020	.M
Model	Current (A)	Connection
		M = Terminal block

#### ATTENUATION INDICATOR

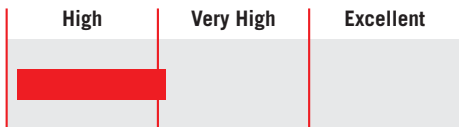

#### ELECTRIC DIAGRAM

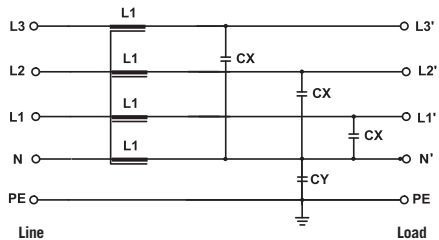

#### TECHNICAL SPECIFICATIONS

Nominal voltage	0 / 480 Vac
Frequency	50 – 60 Hz
Rated current	3 to 20A
Potential test voltage phase to phase	2200 Vdc (2 sec.)
Potential test voltage phase to ground	2900 Vdc (2 sec.)
Leakage current normal conditions	< 1 mA *
Leakage current worst conditions	< 3 mA
IP Protection	IP20
Overload capability	4 x Rated current (Switch ON) 2 x In 10 seconds 1.5 In for 10 minutes
Climatic class	-40 / +85° C
MTBF at 40°C	250.000 Hrs

\* Voltage 230 Vac phase to ground 50 Hz / 40°C

### ELECTRICAL CHARACTERISTICS

FIN15	Rated Current 40°C	Rated Current 50°C	Power Loss (W)
.003.M	3	2	1.5
.006.M	6	5	2.1
.010.M	10	8	2.8
.016.M	16	14	3.2
.020.M	20	17	4

### CONNECTIONS

LINE			PE
Solid Cable (mm <sup>2</sup> )	Stranded Cable (mm <sup>2</sup> )	Terminal Block Torque (Nm)	Torque (Nm)
0.2 - 6	0.2 - 4	0.8	0.8
0.2 - 6	0.2 - 4	0.8	0.8
0.2 - 6	0.2 - 4	0.8	0.8
0.2 - 6	0.5 - 4	0.8	0.8
0.2 - 6	0.5 - 4	0.8	0.8

### TYPICAL ATTENUATION

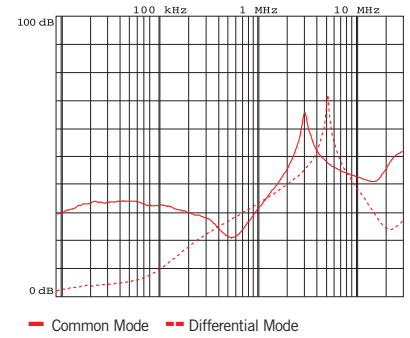

### MECHANICAL DIMENSIONS mm

FIN15	A	B	H	N	Weight Kg.	Case
.003.M	65	85	39	11	0.32	1
.006.M	65	85	39	11	0.32	1
.010.M	65	85	39	11	0.32	1
.016.M	65	85	39	11	0.32	1
.020.M	65	85	39	11	0.32	1

### CASE 1

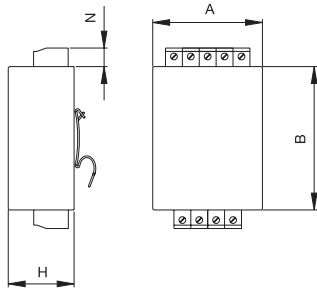

### ASSEMBLY CONNECTION "M"

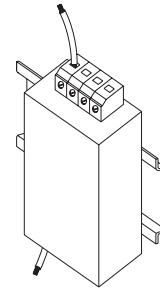



### EMI/RFI Filter with excellent attenuation for industrial applications

Datasheet 3/2019

#### APPROVALS:



UL1283  
CSA C22.2



SCCR by UL508A



**FIN1240.(005 - 150).M**

#### FEATURES

- Rated current from 5 to 2000A
- Excellent differential and common mode attenuation
- Very low leakage current

#### BENEFITS

- 5 Year warranty
- Suitable for medical applications
- Compact design



**FIN1240.200.V**

#### MARKETS

- Semiconductor machinery
- Medical machinery
- Automated machinery

#### ORDERING CODE

FIN 1240	.150	.M
Model	Current (A)	Connection
		M = Terminal block
		V = Screws
		B = Bus bar

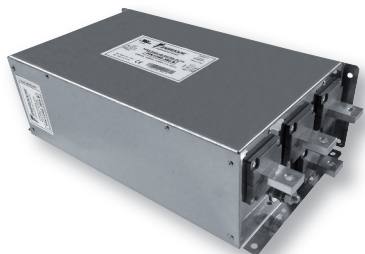

**FIN1240.(360 - 1000).B**

Models available with current ratings up to 2000A

#### ATTENUATION INDICATOR

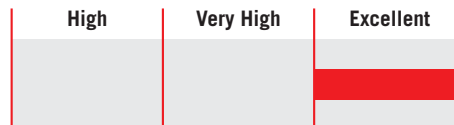

#### ELECTRIC DIAGRAM

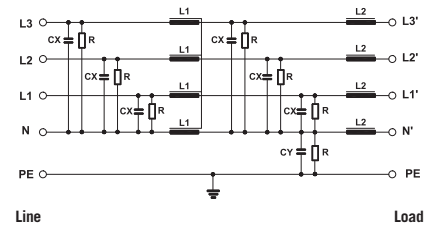

#### TECHNICAL SPECIFICATIONS

Nominal voltage	0 / 480 Vac
Frequency	50 – 60 Hz
Rated current	5 to 1000A
Potential test voltage phase to phase	2200 Vdc (2 sec.)
Potential test voltage phase to ground	2900 Vdc (2 sec.)
Leakage current normal conditions	< 3 mA *
Leakage current worst conditions	< 10 mA
IP Protection	IP20
Overload capability	IP00 over 200A ** 4 x Rated current (Switch ON) 2 x In 10 seconds 1.5 In for 10 minutes
Climatic class	-40 / +85° C
MTBF at 40°C	250.000 Hrs

\* Voltage 230 Vac phase to ground 50 Hz / 40°C  
\*\* Protection cover available

### ELECTRICAL CHARACTERISTICS

FIN1240	Rated Current 40°C	Rated Current 50°C	Power Loss (W)
.005.M	5	4	5
.010.M	10	8	7
.016.M	16	14	14
.030.M	30	27	11
.050.M	50	46	10
.080.M	80	75	35
.100.M	100	90	42
.150.M	150	140	74

### CONNECTIONS

LINE			PE	
Solid Cable (mm <sup>2</sup> )	Stranded Cable (mm <sup>2</sup> )	Terminal Torque (Nm)	d1 (mm)	Torque (Nm)
0.2 - 10	0.2 - 6	1.2	M4	2
0.2 - 10	0.2 - 6	1.2	M4	2
0.2 - 10	0.2 - 6	1.2	M5	4
0.2 - 10	0.2 - 6	1.2	M5	4
0.5 - 16	0.5 - 10	1.8	M6	6
4 - 25	6 - 35	4.5	M8	14
4 - 25	6 - 35	4.5	M8	14
10 - 50	10 - 50	4	M10	18

### TYPICAL ATTENUATION

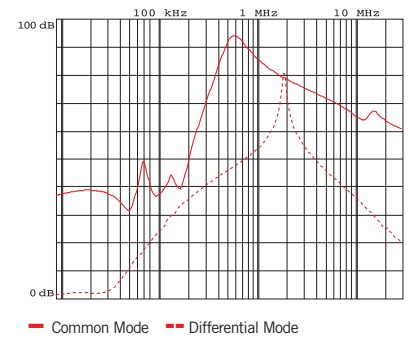

FIN1240	Rated Current 40°C	Rated Current 50°C	Power Loss (W)
.200.V	200	190	75
.360.B	360	345	96
.500.B	500	465	101
.750.B	750	710	103
.1000.B	1000	940	115

LINE		PE	
d (mm)	Torque (Nm)	d1 (mm)	Torque (Nm)
M10	18	M10	18
M8	14	M10	18
M10	25	M10	18
M12	50	M12	20
M12	50	M12	20



### MECHANICAL DIMENSIONS mm

FIN1240	A	B	V	V1	F	H	I	L	N	d1	P	Weight Kg.	Case
.005.M	58	86	19	11	4.5	186	160	176	30	M4	40	1.5	1
.010.M	58	86	19	11	4.5	186	160	176	30	M4	40	1.5	1
.016.M	90	100	19	15	4.5	246	220	235	35	M5	70	2	2
.030.M	90	100	19	15	4.5	246	220	235	35	M5	70	2.5	2
.050.M	90	100	20	25	4.5	246	220	235	35	M6	70	3	3
.080.M	90	185	25	38	6.5	356	320	340	77.5	M8	70	12	4
.100.M	90	185	25	38	6.5	356	320	340	77.5	M8	70	13	4
.150.M	90	220	28	42	6.5	356	320	340	95	M10	70	15	5

### CASE 1, 2, 3

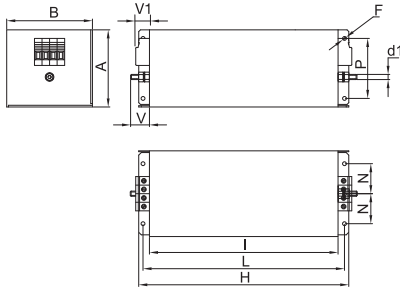

### ASSEMBLY CONNECTION "M"

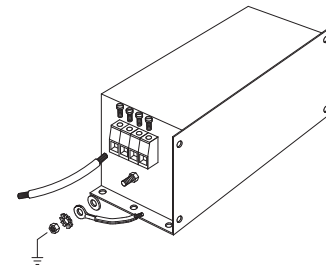

### CASE 4, 5

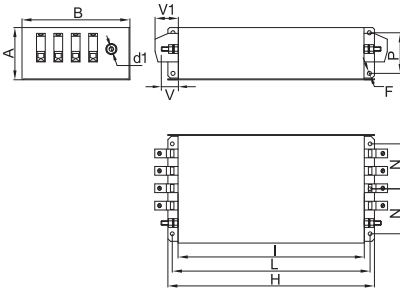

### ASSEMBLY CONNECTION "M"

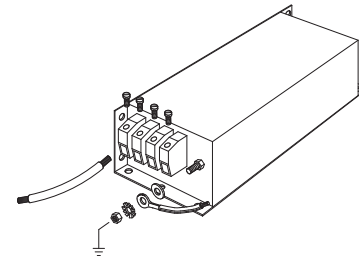



### MECHANICAL DIMENSIONS mm

FIN1240	A	B	C	d	d1	d2	d3	V	F	H	I	L	N	P	S	Weight Kg.	Case
.200.V	90	220	120	M10	M10	-	-	30	6.5	356	320	340	95	70	60	20	6
.360.B	130	230	150	M8	M8	10	25	42	6.5	420	380	400	100	100	90	27	7
.500.B	130	230	150	M8	M8	15	30	48	6.5	510	450	480	100	100	90	33.5	8
.750.B	160	250	140	M10	M10	20	40	94	8.5	510	450	480	100	110	110	37	9
.1000.B	210	350	200	M12	M12	20	60	97	8.5	610	550	580	150	160	147	55	10

### CASE 6

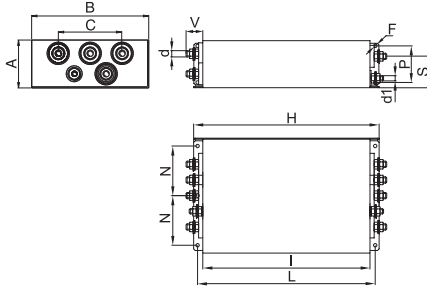

### ASSEMBLY CONNECTION "V"

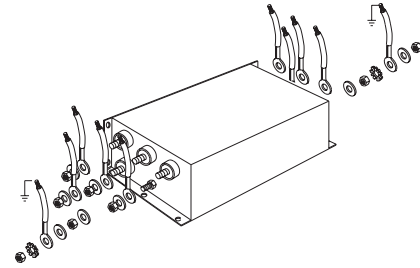

### CASE 7, 8, 9, 10

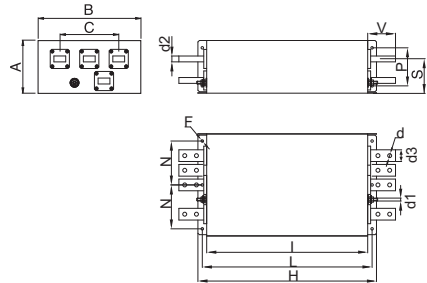

### ASSEMBLY CONNECTION "B"

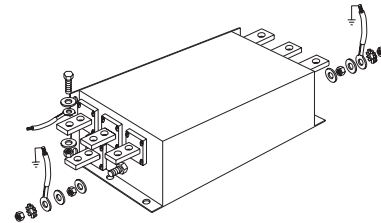



Datasheet 3/2019

### EMI/RFI Filter with excellent attenuation for industrial, residential and medical applications

#### APPROVALS:



UL1283  
CSA C22.2



SCCR by UL508A



FIN1740.(006 – 200).M

#### FEATURES

- Rated current from 6 to 200A
- Excellent differential and common mode attenuation
- Low leakage current
- DIN rail mounting

#### BENEFITS

- 5 Year warranty
- Suitable for medical applications
- Compact design

#### MARKETS

- Conveyors
- Packaging machinery
- Woodworking machinery
- Medical equipment

#### ORDERING CODE

FIN1740 .055 .M  
 Model Current (A) Connection  
 M = Terminal block

#### ATTENUATION INDICATOR

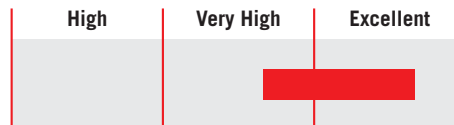

#### ELECTRIC DIAGRAM

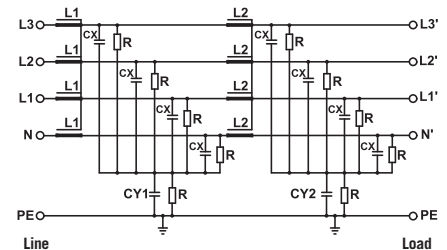

#### TECHNICAL SPECIFICATIONS

Nominal voltage	0 / 600 Vac
Frequency	50 – 60 Hz
Rated current	6 to 200A
Potential test voltage phase to phase	2400 Vdc (2 sec.)
Potential test voltage phase to ground	3200 Vdc (2 sec.)
Leakage current normal conditions	< 3 mA *
Leakage current worst conditions	< 15 mA
IP Protection	IP20
Overload capability	4 x Rated current (Switch ON) 2 x In 10 seconds 1.5 In for 10 minutes
Climatic class	-40 / +85° C
MTBF at 40°C	250.000 Hrs

\* Voltage 230 Vac phase to ground 50 Hz / 40°C

### ELECTRICAL CHARACTERISTICS

FIN1740	Rated Current 40°C	Rated Current 50°C	Power Loss (W)
.006.M	8	6	8
.012.M	14	12	10
.016.M	18	16	12
.025.M	28	25	15
.032.M	35	32	23
.042.M	50	42	32
.055.M	63	55	37
.070.M	80	70	52
.080.M	90	80	60
.100.M	110	100	92
.115.M	130	115	101
.150.M	175	150	115
.200.M	230	200	120

### CONNECTIONS

LINE			PE	
Solid Cable (mm <sup>2</sup> )	Stranded Cable (mm <sup>2</sup> )	Terminal Torque (Nm)	d (mm)	Torque (Nm)
0.2 - 10	0.2 - 6	1.2	M6	6
0.2 - 10	0.2 - 6	1.2	M6	6
0.2 - 10	0.2 - 6	1.2	M6	6
0.2 - 10	0.2 - 6	1.2	M6	6
0.2 - 10	0.2 - 6	1.2	M6	6
0.5 - 16	0.5 - 10	1.8	M6	6
0.5 - 16	0.5 - 10	1.8	M6	6
4 - 25	6 - 35	4.5	M10	18
4 - 25	6 - 35	4.5	M10	18
10 - 50	10 - 50	4	M10	18
10 - 50	10 - 50	4	M10	18
35 - 95	35 - 95	20	M10	18
35 - 95	35 - 95	20	M10	18

### TYPICAL ATTENUATION

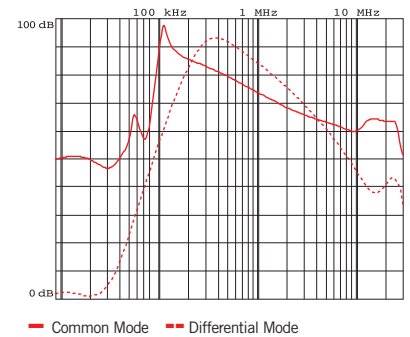

### MECHANICAL DIMENSIONS mm

FIN1740	A	B	V	V1	F	H	I	L	N	d	Weight Kg.	Case
.006.M	140	60	19	16	6	226	200	7	38	M6	1.9	1
.012.M	140	60	19	16	6	226	200	7	38	M6	1.9	1
.016.M	177	70	19	16	6	267	237	8	44	M6	1.9	1
.025.M	177	70	19	16	6	267	237	8	44	M6	2.5	1
.032.M	177	70	19	16	6	267	237	8	44	M6	2.5	1
.042.M	177	80	19	34	6	295	265	8	54	M6	3.7	1
.055.M	177	80	19	33	6	295	265	8	54	M6	3.9	1
.070.M	205	100	28.5	38	8	390	340	12	73	M10	6.2	1
.080.M	205	100	28.5	38	8	390	340	12	73	M10	6.2	1
.100.M	205	100	28.5	43	8	390	340	12	73	M10	7.5	1
.115.M	205	100	28.5	43	8	390	340	12	73	M10	7.5	1
.150.M	220	130	28.5	50	8	420	370	12	103	M10	9.4	1
.200.M	220	130	28.5	50	8	420	370	12	103	M10	9.4	1

### CASE 1

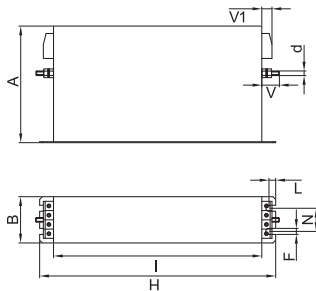

### ASSEMBLY CONNECTION "M"

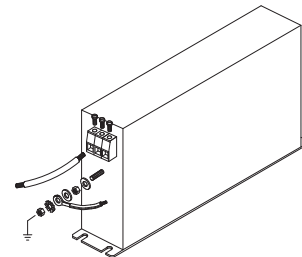



### EMI/RFI Filter with very high attenuation for industrial applications

Datasheet 3/2019



**FIN1740ESM.(010 – 180).M**

#### FEATURES

- Rated current from 10 to 180A
- Very high differential and common mode attenuation
- Low leakage current

#### MARKETS

- Conveyors
- Automated machinery
- 3D printers
- Medical equipment

#### APPROVALS:



UL1283  
CSA C22.2



**SCCR** by UL508A

#### BENEFITS

- 5 Year warranty
- Suitable for medical applications
- Compact design

#### ORDERING CODE

FIN 1740ESM .072 .M  
Model Current (A) Connection  
M = Terminal block

#### ATTENUATION INDICATOR

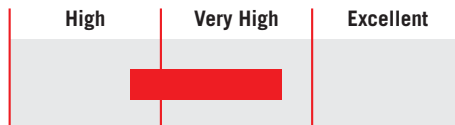

#### ELECTRIC DIAGRAM

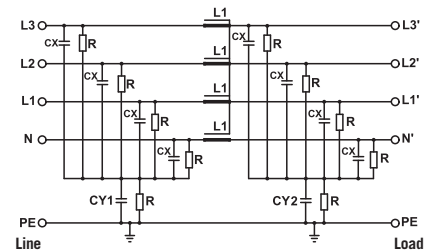

#### TECHNICAL SPECIFICATIONS

Nominal voltage	0 / 500 Vac
Frequency	50 – 60 Hz
Rated current	10 to 180A
Potential test voltage phase to phase	2300 Vdc (2 sec.)
Potential test voltage phase to ground	3100 Vdc (2 sec.)
Leakage current normal conditions	< 3 mA *
Leakage current worst conditions	< 15 mA
IP Protection	IP20
Overload capability	4 x Rated current (Switch ON) 2 x In 10 seconds 1.5 In for 10 minutes
Climatic class	-40 / +85° C
MTBF at 40°C	250.000 Hrs

\* Voltage 230 Vac phase to ground 50 Hz / 40°C

### ELECTRICAL CHARACTERISTICS

FIN1740ESM	Rated Current 40°C	Rated Current 50°C	Power Loss (W)
.010.M	10	9	5
.018.M	18	16	5
.036.M	36	32	18
.072.M	72	64	40
.100.M	100	90	102
.135.M	135	120	96
.180.M	180	160	98

### CONNECTIONS

LINE			PE	
Solid Cable (mm <sup>2</sup> )	Stranded Cable (mm <sup>2</sup> )	Terminal Torque (Nm)	d (mm)	Torque (Nm)
0.2 - 10	0.2 - 6	1.2	M6	6
0.2 - 10	0.2 - 6	1.2	M6	6
0.2 - 10	0.2 - 6	1.2	M6	6
0.5 - 16	0.5 - 10	1.8	M6	6
4 - 25	6 - 35	4.5	M10	18
10 - 50	10 - 50	4	M10	18
35 - 95	35 - 95	20	M10	18

### TYPICAL ATTENUATION

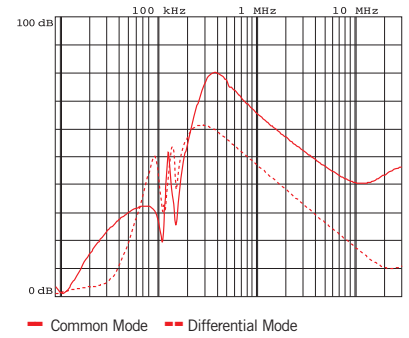

### MECHANICAL DIMENSIONS mm

FIN1740ESM	A	B	V	V1	F	H	I	L	N	d	Weight Kg.	Case
.010.M	100	130	22.5	16	6.5	153	125	8.5	90	M6	1	1
.018.M	100	130	22.5	16	6.5	153	125	8.5	90	M6	1	1
.036.M	100	130	22.5	16	6.5	153	125	8.5	90	M6	1.1	1
.072.M	125	118	22.5	32.5	6.5	153	128	8.5	50	M6	1.6	1
.100.M	140	180	30	39	6.5	170	140	8.5	65	M10	3.4	1
.135.M	140	180	30	43	6.5	170	140	8.5	65	M10	4.5	1
.180.M	160	200	30	51.5	6.5	170	140	8.5	75	M10	4.8	1

### CASE 1

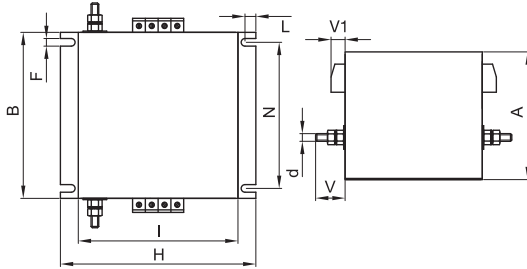

### ASSEMBLY CONNECTION "M"

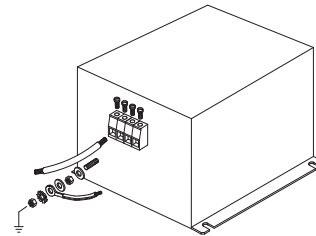



### EMI/RFI Filter with excellent attenuation for industrial applications

Datasheet 3/2019



**FIN1940.(006 – 200).M**

#### FEATURES

- Rated current from 6 to 200A
- Excellent differential and common mode attenuation
- Low leakage current

#### MARKETS

- Printing machinery
- Laser equipment
- CNC machinery
- Multiple drive installations

#### APPROVALS:

**UL** **US** UL1283  
E215863 CSA C22.2

**RoHS**

**CE**

**SCCR** by UL508A

#### BENEFITS

- 5 Year warranty
- High attenuation in low frequency range
- Compact design

#### ORDERING CODE

FIN1940 .055 .M  
Model Current (A) Connection  
M = Terminal block

#### ATTENUATION INDICATOR

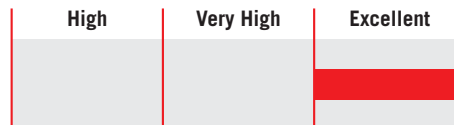

#### ELECTRIC DIAGRAM

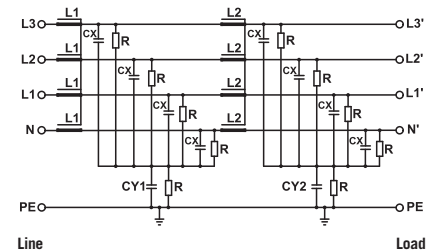

#### TECHNICAL SPECIFICATIONS

Nominal voltage	0 / 600 Vac
Frequency	50 – 60 Hz
Rated current	6 to 200A
Potential test voltage phase to phase	2400 Vdc (2 sec.)
Potential test voltage phase to ground	3200 Vdc (2 sec.)
Leakage current normal conditions	< 3 mA *
Leakage current worst conditions	< 15 mA
IP Protection	IP20
Overload capability	4 x Rated current (Switch ON) 2 x In 10 seconds 1.5 In for 10 minutes
Climatic class	-40 / +85° C
MTBF at 40°C	250.000 Hrs

\* Voltage 230 Vac phase to ground 50 Hz / 40°C

### ELECTRICAL CHARACTERISTICS

FIN1940	Rated Current 40°C	Rated Current 50°C	Power Loss (W)
.006.M	8	6	8
.012.M	14	12	10
.016.M	18	16	12
.025.M	28	25	15
.032.M	35	32	23
.042.M	50	42	32
.055.M	63	55	37
.070.M	80	70	52
.080.M	90	80	60
.100.M	110	100	92
.115.M	130	115	101
.150.M	175	150	115
.200.M	230	200	120

### CONNECTIONS

LINE			PE	
Solid Cable (mm <sup>2</sup> )	Stranded Cable (mm <sup>2</sup> )	Terminal Torque (Nm)	d (mm)	Torque (Nm)
0.2 - 10	0.2 - 6	1.2	M6	6
0.2 - 10	0.2 - 6	1.2	M6	6
0.2 - 10	0.2 - 6	1.2	M6	6
0.2 - 10	0.2 - 6	1.2	M6	6
0.2 - 10	0.2 - 6	1.2	M6	6
0.5 - 16	0.5 - 10	1.8	M6	6
0.5 - 16	0.5 - 10	1.8	M6	6
4 - 25	6 - 35	4.5	M10	18
4 - 25	6 - 35	4.5	M10	18
10 - 50	10 - 50	4	M10	18
10 - 50	10 - 50	4	M10	18
35 - 95	35 - 95	20	M10	18
35 - 95	35 - 95	20	M10	18

### TYPICAL ATTENUATION

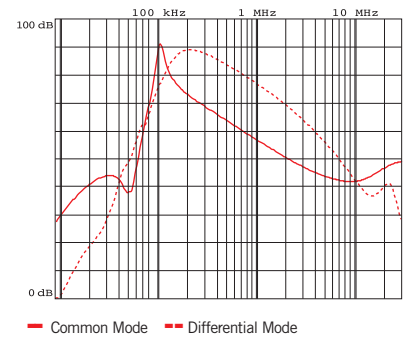

### MECHANICAL DIMENSIONS mm

FIN1940	A	B	V	V1	F	H	I	L	N	d	Weight Kg.	Case
.006.M	140	60	19	16	6	226	200	7	38	M6	1.9	1
.012.M	140	60	19	16	6	226	200	7	38	M6	1.9	1
.016.M	177	70	19	16	6	267	237	8	44	M6	1.9	1
.025.M	177	70	19	16	6	267	237	8	44	M6	2.5	1
.032.M	177	70	19	16	6	267	237	8	44	M6	2.5	1
.042.M	177	80	19	34	6	295	265	8	54	M6	3.7	1
.055.M	177	80	19	33	6	295	265	8	54	M6	3.9	1
.070.M	205	100	28.5	38	8	390	340	12	73	M10	6.2	1
.080.M	205	100	28.5	38	8	390	340	12	73	M10	6.2	1
.100.M	205	100	28.5	43	8	390	340	12	73	M10	7.5	1
.115.M	205	100	28.5	43	8	390	340	12	73	M10	7.5	1
.150.M	220	130	28.5	50	8	420	370	12	103	M10	9.4	1
.200.M	220	130	28.5	50	8	420	370	12	103	M10	9.4	1

### CASE 1

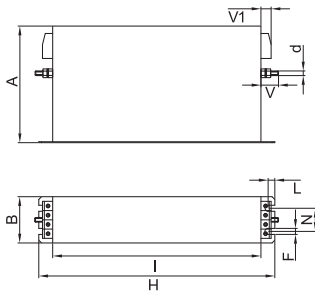

### ASSEMBLY CONNECTION "M"

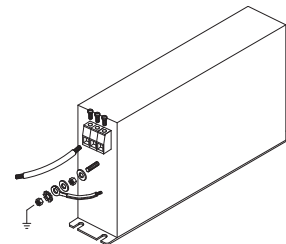



### EMI/RFI Filter with excellent attenuation for industrial, residential and medical applications

Datasheet 3/2019



**FIN1940E.(018 – 200).M**

#### FEATURES

- Rated current from 18 to 200A
- Very high differential and common mode attenuation
- Very low leakage current

#### MARKETS

- Conveyors
- Automated machinery
- 3D printers
- Medical equipment

#### APPROVALS:



UL1283  
CSA C22.2



**SCCR** by UL508A

#### BENEFITS

- 5 Year warranty
- Excellent attenuation in low frequency range
- Compact design

#### ORDERING CODE

FIN 1940E .018 .M  
Model Current (A) Connection  
M = Terminal block

#### ATTENUATION INDICATOR

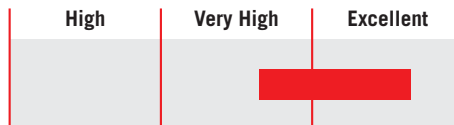

#### ELECTRIC DIAGRAM

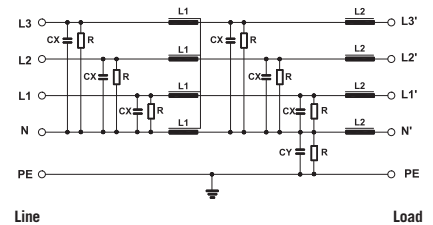

#### TECHNICAL SPECIFICATIONS

Nominal voltage	0 / 500 Vac
Frequency	50 – 60 Hz
Rated current	18 to 200A
Potential test voltage phase to phase	2300 Vdc (2 sec.)
Potential test voltage phase to ground	3100 Vdc (2 sec.)
Leakage current normal conditions	< 3 mA *
Leakage current worst conditions	< 15 mA
IP Protection	IP20
Overload capability	4 x Rated current (Switch ON) 2 x In 10 seconds 1.5 In for 10 minutes
Climatic class	-40 / +85° C
MTBF at 40°C	250.000 Hrs

\* Voltage 230 Vac phase to ground 50 Hz / 40°C



### ELECTRICAL CHARACTERISTICS

FIN1940E	Rated Current 40°C	Rated Current 50°C	Power Loss (W)
.018.M	18	16	5
.036.M	36	32	18
.072.M	72	64	40
.100.M	100	90	102
.130.M	130	120	96
.200.M	200	180	98

### CONNECTIONS

LINE			PE	
Solid Cable (mm <sup>2</sup> )	Stranded Cable (mm <sup>2</sup> )	Terminal Torque (Nm)	d (mm)	Torque (Nm)
0.2 - 10	0.2 - 6	1.2	M5	4
0.2 - 10	0.2 - 6	1.2	M6	6
0.5 - 16	0.5 - 10	1.8	M10	18
4 - 25	6 - 35	4.5	M10	18
10 - 50	10 - 50	4	M10	18
35 - 95	35 - 95	20	M10	18

### TYPICAL ATTENUATION

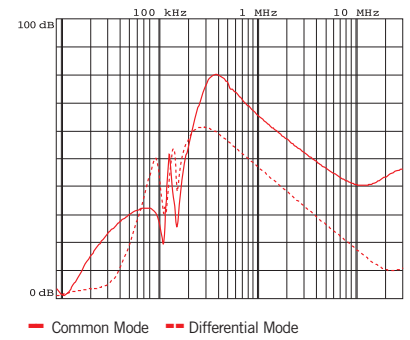

### MECHANICAL DIMENSIONS mm

FIN1940E	A	B	C	D	E	F	H	d	V	V1	Weight Kg.	Case
.018.M	120	115	143	127.5	80	6.5	80	M5	23.5	11.2	1	1
.036.M	130	125	153	137.5	90	6.5	115	M6	23.5	14.5	1.1	2
.072.M	160	125	153	137.5	100	6.5	125	M10	28	32.5	1.6	3
.100.M	230	135	163	147.5	60	6.5	125	M10	27.5	38.5	3.4	4
.130.M	250	140	170	153.5	100	6.5	140	M10	27.5	43	4.5	5
.200.M	280	140	170	153.5	115	6.5	170	M10	27.5	50	4.8	6

### CASE 1, 2, 3

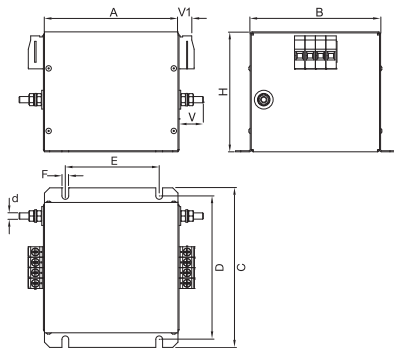

### ASSEMBLY CONNECTION "M"

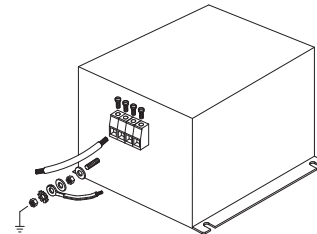



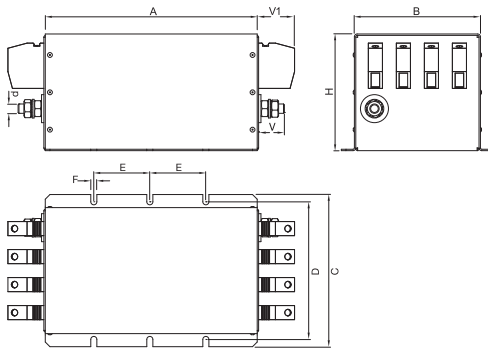

### CASE 4, 5, 6

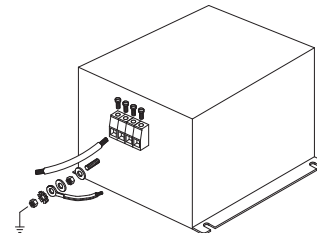

### ASSEMBLY CONNECTION "M"



Filter Selection Guide	Description	Current Range (A)	Voltage DC	CONNECTORS		FEATURES			APPLICATIONS			Approval
				Screws	Bus Bar	High Attenuation	Chassis Insulated (0 Volt)	Very Low Leakage Current	PV with PE Insulated	Recharging Station	Renewable Energy	
<b>DC Filters</b>												
<b>FIN1220</b>	2-phase filter	5-3000	0-1000	X	X			X		X	X	
<b>FIN1220.OV</b>	2-phase filter	5-3000	0-1000	X	X		X	X	X			
<b>FIN1520</b>	2-phase filter	5-3000	0-1000	X	X	X				X	X	
<b>FIN1520.OV</b>	2-phase filter	5-3000	0-1000	X	X	X	X		X			
<b>FIN7212</b>	2-phase filter	150-3000	0-1000		X		X		X		X	

Enerdoor DC filter series is designed specifically for the photovoltaic industry. This series carries CE and UL approvals and offers a current range from 5 to 3000A with nominal voltage up to 1000 Vdc.

The FIN1220, FIN1520 and FIN7212 filters are installed between PV inverters and solar panels to reduce Electromagnetic interference on the DC power line.

The FIN1220.0V, FIN1520.0V and FIN7212 filters offer the possibility of the ground connection being separated from the virtual zero point. This is particularly beneficial for critical networks on the protective earth conductor.

This series features a compact case with screw and bus bar connectors. Customized solutions are available to satisfy various application requirements.

**DC Filter applications include:**

- Single phase machines up to 700 Vac
- Renewable energy
- Recharging stations
- AC/DC converters

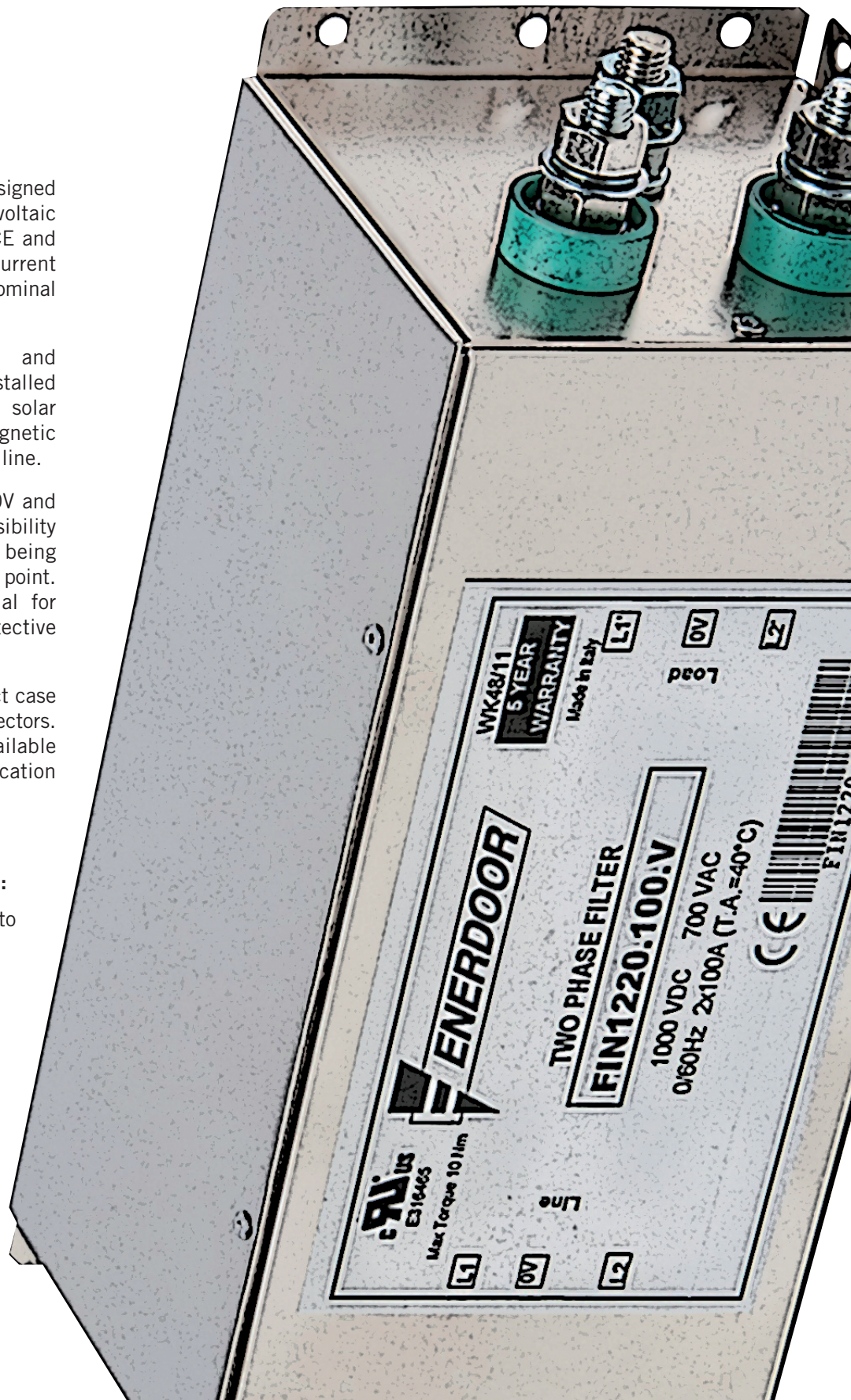



## EMI/RFI DC Filter with very high attenuation for DC industrial and residential applications

Datasheet 3/2019

### APPROVALS:

UL1283  
CSA C22.2  
E215863



SCCR by UL508A

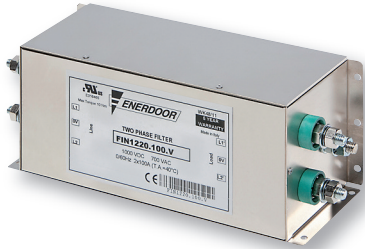

**FIN1220.(005 - 280).V**



**FIN1220.(280 - 1750).B**



**FIN1220.(2000 - 3000).B**

### FEATURES

- Rated current from 5 to 3000A
- Very high common mode attenuation
- Very low leakage current

### BENEFITS

- 5 Year warranty
- Various connections available
- Finger safe protection available

### MARKETS

- Renewable energy
- Recharging stations
- AC/DC converters
- Single phase machines up to 700 Vac

### ORDERING CODE

FIN1220	.100	.V
Model	Current (A)	Connection
		V = Screw
		B = Bus bar

### ATTENUATION INDICATOR

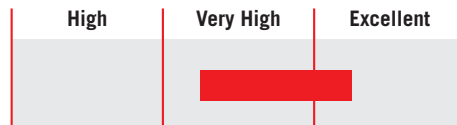

### ELECTRIC DIAGRAM

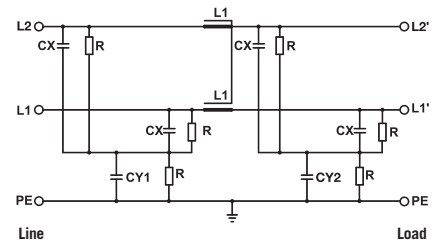

### TECHNICAL SPECIFICATIONS

Nominal voltage	0 / 1000 Vdc - 0 / 700 Vac
Frequency	50 – 60 Hz
Rated current	5 to 3000A
Potential test voltage phase to phase	3100 Vdc (2 sec.)
Potential test voltage phase to ground	3400 Vdc (2 sec.)
Leakage current normal conditions	< 3 mA *
Leakage current worst conditions	< 10 mA
IP Protection	IP20 up to 280A IP00 over 280A IP20 available with protection FINPRT
Overload capability	4 x Rated current (Switch ON) 2 x In 10 seconds 1.5 In for 10 minutes
Climatic class	-40 / +85° C
MTBF at 40°C	250.000 Hrs

\* Voltage 230 Vac phase to ground 50Hz / 40°C



### ELECTRICAL CHARACTERISTICS

FIN1220	Rated Current 40°C	Rated Current 50°C	Power Loss (W)
.005.V	5	4	5
.010.V	10	8	7
.016.V	16	14	14
.030.V	30	27	11
.050.V	50	46	10
.080.V	80	75	39
.100.V	100	90	45
.130.V	130	110	49
.150.V	150	140	69
.180.V	180	165	77
.200.V	200	190	85
.250.V	272	250	87
.280.V	297	280	77
.280.B	330	320	76
.320.B	330	320	77
.360.B	390	360	98
.400.B	435	400	102
.500.B	545	500	96
.600.B	654	600	102
.750.B	800	750	88
.900.B	940	900	72
.1000.B	1050	1000	102
.1250.B	1290	1250	96
.1500.B	1550	1500	108
.1600.B	1650	1600	115
.1750.B	1800	1750	120
.2000.B	2050	2000	122
.2250.B	2300	2250	127
.2500.B	2550	2500	140
.3000.B	3000	2950	150

### CONNECTIONS

LINE		PE	
d (mm)	Torque (Nm)	d1 (mm)	Torque (Nm)
M4	1.2	M4	1.2
M4	1.2	M4	1.2
M5	4	M5	4
M5	4	M5	4
M6	6	M5	4
M8	14	M8	14
M8	14	M8	14
M10	18	M10	18
M10	18	M10	18
M10	18	M10	18
M10	18	M10	18
M12	20	M10	18
M12	20	M10	18
M8	14	M10	18
M8	14	M10	18
M8	14	M10	18
M8	14	M10	18
M10	25	M10	18
M10	25	M10	18
M12	50	M12	20
M12	50	M12	20
M12	50	M12	20
M12	50	M12	20
M12	50	M12	20
M12	50	M12	20
M12	50	M12	20
M12	50	M12	20
M12	50	M12	20
M12	50	M12	20

### TYPICAL ATTENUATION

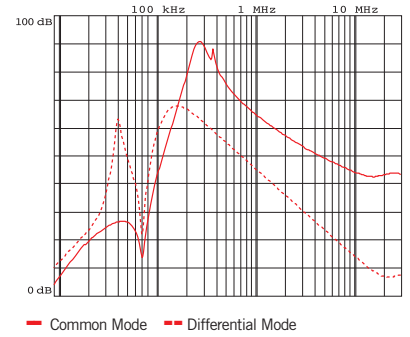

Typical attenuation 7A – 400A

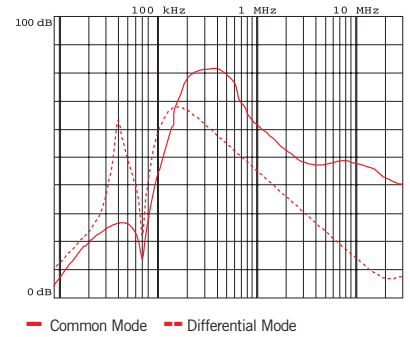

Typical attenuation 500A – 3000A

**MECHANICAL DIMENSIONS mm**

FIN1220	A	B	C	d	d1	V	F	H	I	L	N	P	S	Weight Kg.	Case
.005.V	58	86	44	M4	M4	14	4.5	186	160	176	30	40	38	2	1
.010.V	58	86	44	M4	M4	14	4.5	186	160	176	30	40	38	2	1
.016.V	90	100	46	M5	M5	28	4.5	246	220	235	35	70	64	3	2
.030.V	90	100	46	M5	M5	28	4.5	246	220	235	35	70	64	3	2
.050.V	90	100	46	M6	M6	28	4.5	246	220	235	35	70	64	3	3
.080.V	90	100	40	M8	M8	28	4.5	246	220	235	35	70	69	3	4
.100.V	90	100	40	M8	M8	28	4.5	246	220	235	35	70	69	3	4
.130.V	90	185	120	M10	M10	29	6.5	356	320	340	77.5	70	60	5	5
.150.V	90	185	120	M10	M10	29	6.5	356	320	340	77.5	70	60	5	5
.180.V	90	185	120	M10	M10	29	6.5	356	320	340	77.5	70	60	5	5
.200.V	90	185	120	M10	M10	29	6.5	356	320	340	77.5	70	60	5	5
.250.V	90	220	120	M12	M12	30	6.5	356	320	340	95	70	60	7.5	6
.280.V	90	220	120	M12	M12	30	6.5	356	320	340	95	70	60	7.5	6

**CASE 1, 2, 3, 4**

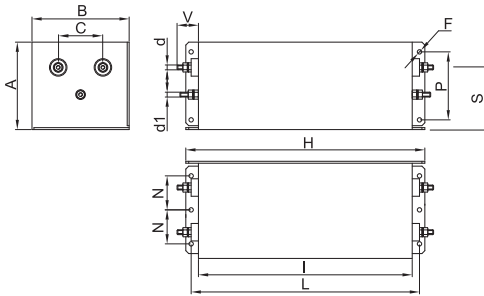

**ASSEMBLY CONNECTION "V"**

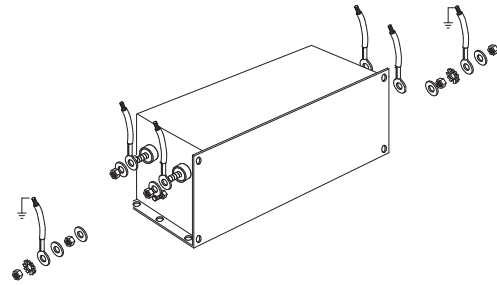

**CASE 5, 6**

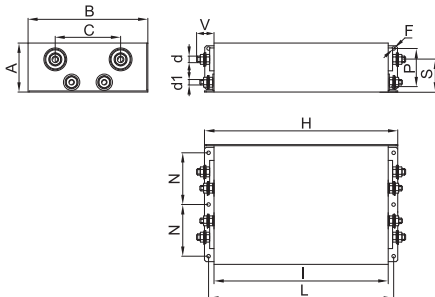

**ASSEMBLY CONNECTION "V"**

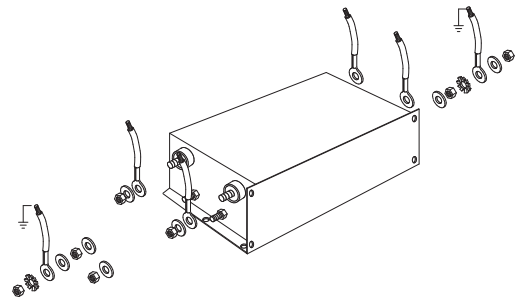

**MECHANICAL DIMENSIONS mm**

FIN1220	A	B	C	d	d1	d2	d3	V	F	H	I	L	N	N1	P	S	Weight Kg.	Case
.280.B	90	220	120	M8	M10	6	20	42	6.5	356	320	340	50	190	70	55	7.5	7
.320.B	90	220	120	M8	M10	6	20	42	6.5	356	320	340	50	190	70	55	7.5	7
.360.B	130	230	150	M8	M10	10	25	42	6.5	420	380	400	70	200	85	85	10	8
.400.B	130	230	150	M8	M10	10	25	42	6.5	420	380	400	70	200	85	85	10	8
.500.B	130	230	150	M8	M10	10	25	42	6.5	420	380	400	70	200	85	85	10	8
.600.B	130	230	150	M10	M10	15	30	48	6.5	510	450	480	70	200	100	85	15.5	9
.750.B	130	230	150	M10	M10	15	30	48	6.5	510	450	480	70	200	100	85	15.5	9
.900.B	160	250	140	M12	M12	20	40	94	8.5	510	450	480	70	200	110	110	23	10
.1000.B	160	250	140	M12	M12	20	40	94	8.5	510	450	480	70	200	110	110	23	10
.1250.B	160	250	140	M12	M12	20	40	94	8.5	510	450	480	70	200	110	110	23	10
.1500.B	180	300	200	M12	M12	20	60	97	8.5	560	500	530	80	250	130	117	27	11
.1600.B	180	300	200	M12	M12	20	60	97	8.5	560	500	530	80	250	130	117	27	11
.1750.B	180	300	200	M12	M12	20	60	97	8.5	560	500	530	80	250	130	117	27	11
.2000.B	225	350	200	M12	M12	25	80	100	8.5	610	550	580	150	-	-	112.5	45	12
.2250.B	225	350	200	M12	M12	25	80	100	8.5	610	550	580	150	-	-	112.5	45	12
.2500.B	225	350	200	M12	M12	25	80	100	8.5	610	550	580	150	-	-	112.5	45	12
.3000.B	225	350	200	M12	M12	25	80	100	8.5	610	550	580	150	-	-	112.5	45	12

**CASE 7, 8, 9**

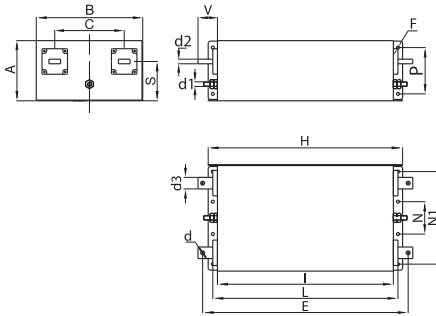

**ASSEMBLY CONNECTION "B"**

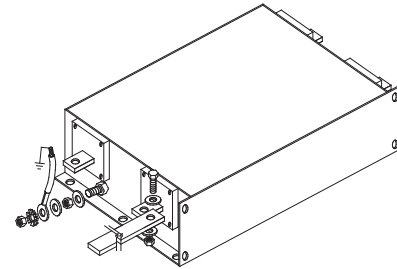

**CASE 10, 11**

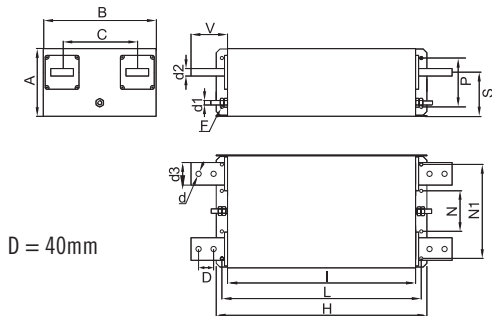

**ASSEMBLY CONNECTION "B"**

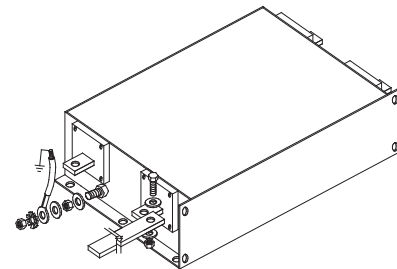

**CASE 12**

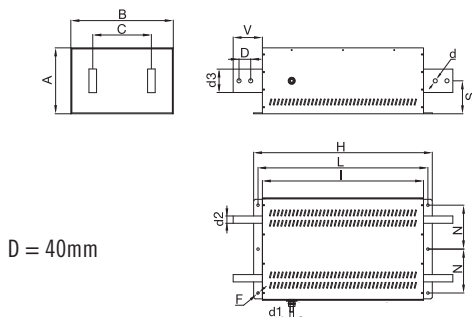

**ASSEMBLY CONNECTION "B"**

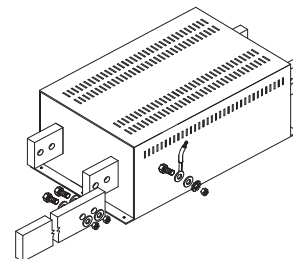



## EMI/RFI DC Filter with very high attenuation and zero volt insulated option for DC industrial applications

Datasheet 3/2019

### APPROVALS:

UL1283  
CSA C22.2  
E215863

RoHS



SCCR by UL508A

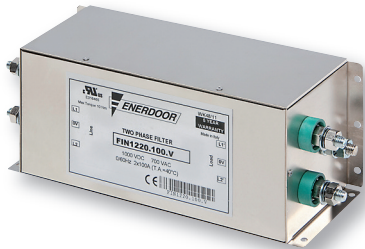

FIN1220.(005 - 280).0V



FIN1220.(280 - 1750).B.0V



FIN1220.(2000 - 3000).B.0V

### FEATURES

- Rated current from 5 to 3000A
- Very high common mode attenuation
- Zero volt connector for PE floating systems

### BENEFITS

- 5 Year warranty
- Various connections available
- Finger safe protection available

### MARKETS

- Renewable energy
- Recharging stations
- AC/DC converters
- Single phase machines up to 700 Vac

### ORDERING CODE

FIN1220	.100	.V	.0V
Model	Current (A)	Connection	PE insulated
		V = Screw	
		B = Bus bar	

### ATTENUATION INDICATOR

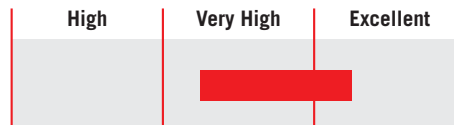

### ELECTRIC DIAGRAM

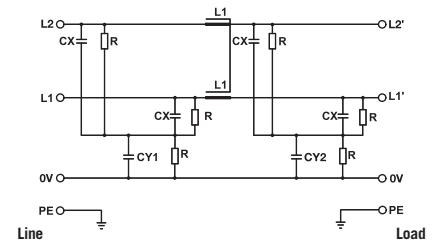

### TECHNICAL SPECIFICATIONS

Nominal voltage	0 / 1000 Vdc - 0 / 700 Vac
Frequency	50 – 60 Hz
Rated current	5 to 3000A
Potential test voltage phase to phase	3100 Vdc (2 sec.)
Potential test voltage phase to ground	3400 Vdc (2 sec.)
Leakage current normal conditions	< 3 mA *
Leakage current worst conditions	< 10 mA
IP Protection	IP20 up to 280A IP00 over 280A IP20 available with protection FINPRT
Overload capability	4 x Rated current (Switch ON) 2 x In 10 seconds 1.5 In for 10 minutes
Climatic class	-40 / +85° C
MTBF at 40°C	250.000 Hrs

\* Voltage 230 Vac phase to ground 50Hz / 40°C



### ELECTRICAL CHARACTERISTICS

FIN1220	Rated Current 40°C	Rated Current 50°C	Power Loss (W)
.005.V.0V	5	4	5
.010.V.0V	10	8	7
.016.V.0V	16	14	14
.030.V.0V	30	27	11
.050.V.0V	50	46	10
.080.V.0V	80	75	39
.100.V.0V	100	90	45
.130.V.0V	130	110	49
.150.V.0V	150	140	69
.180.V.0V	180	165	77
.200.V.0V	200	190	85
.250.V.0V	272	250	87
.280.V.0V	297	280	77
.280.B.0V	330	320	76
.320.B.0V	330	320	77
.360.B.0V	390	360	98
.400.B.0V	435	400	102
.500.B.0V	545	500	96
.600.B.0V	654	600	102
.750.B.0V	800	750	88
.900.B.0V	940	900	72
.1000.B.0V	1050	1000	102
.1250.B.0V	1290	1250	96
.1500.B.0V	1550	1500	108
.1600.B.0V	1650	1600	115
.1750.B.0V	1800	1750	120
.2000.B.0V	2050	2000	122
.2250.B.0V	2300	2250	127
.2500.B.0V	2550	2500	140
.3000.B.0V	3000	2950	150

### CONNECTIONS

LINE		PE		OV	
d (mm)	Torque (Nm)	d1 (mm)	Torque (Nm)	d4 (mm)	Torque (Nm)
M4	1.2	M4	1.2	M4	1.2
M4	1.2	M4	1.2	M4	1.2
M5	4	M5	4	M5	4
M5	4	M5	4	M5	4
M6	6	M5	4	M5	4
M8	14	M8	14	M6	6
M8	14	M8	14	M6	6
M10	18	M10	18	M10	18
M10	18	M10	18	M10	18
M10	18	M10	18	M10	18
M10	18	M10	18	M10	18
M12	20	M10	18	M10	18
M12	20	M10	18	M10	18
M8	14	M10	18	M10	18
M8	14	M10	18	M10	18
M8	14	M10	18	M10	18
M8	14	M10	18	M10	18
M8	14	M10	18	M10	18
M10	25	M10	18	M10	18
M10	25	M10	18	M10	18
M12	50	M12	20	M12	20
M12	50	M12	20	M12	20
M12	50	M12	20	M12	20
M12	50	M12	20	M12	20
M12	50	M12	20	M12	20
M12	50	M12	20	M12	20
M12	50	M12	20	M12	20
M12	50	M12	20	M12	20
M12	50	M12	20	M12	20
M12	50	M12	20	M12	20

### TYPICAL ATTENUATION

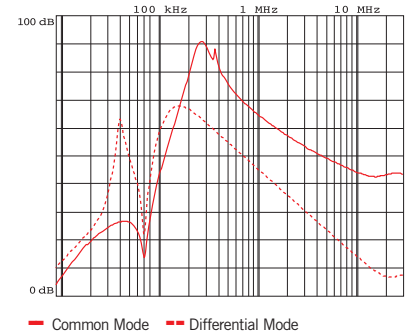

Typical attenuation 5A – 400A

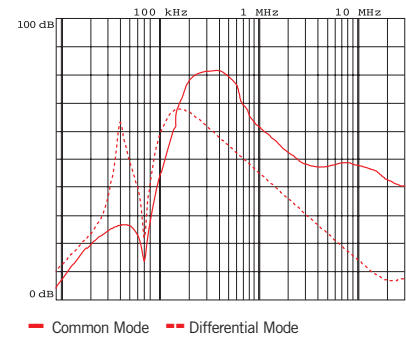

Typical attenuation 500A – 3000A

**MECHANICAL DIMENSIONS mm**

FIN1220	A	B	C	d	d1	d4	V	F	H	I	L	N	P	S	Weight Kg.	Case
.005.V.0V	58	86	44	M4	M4	M4	14	4.5	186	160	176	30	40	38	2	1
.010.V.0V	58	86	44	M4	M4	M4	14	4.5	186	160	176	30	40	38	2	1
.016.V.0V	90	100	46	M5	M5	M5	28	4.5	246	220	235	35	70	64	3	2
.030.V.0V	90	100	46	M5	M5	M5	28	4.5	246	220	235	35	70	64	3	2
.050.V.0V	90	100	46	M6	M5	M5	28	4.5	246	220	235	35	70	64	3	3
.080.V.0V	90	100	40	M8	M8	M6	28	4.5	246	220	235	35	70	69	3	4
.100.V.0V	90	100	40	M8	M8	M6	28	4.5	246	220	235	35	70	69	3	4
.130.V.0V	90	185	120	M10	M10	M10	29	6.5	356	320	340	77.5	70	60	5	5
.150.V.0V	90	185	120	M10	M10	M10	29	6.5	356	320	340	77.5	70	60	5	5
.180.V.0V	90	185	120	M10	M10	M10	29	6.5	356	320	340	77.5	70	60	5	5
.200.V.0V	90	185	120	M10	M10	M10	29	6.5	356	320	340	77.5	70	60	5	5
.250.V.0V	90	220	120	M12	M10	M10	30	6.5	356	320	340	95	70	60	7.5	6
.280.V.0V	90	220	120	M12	M10	M10	30	6.5	356	320	340	95	70	60	7.5	6

**CASE 1, 2, 3, 4**

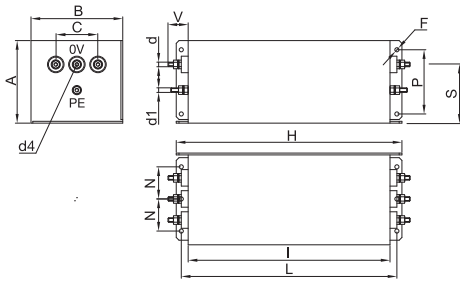

**ASSEMBLY CONNECTION "V"**

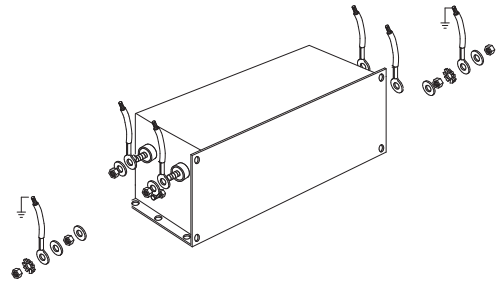

**CASE 5, 6**

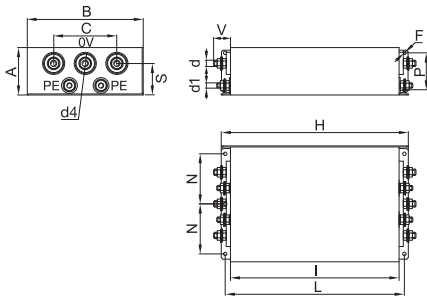

**ASSEMBLY CONNECTION "V"**

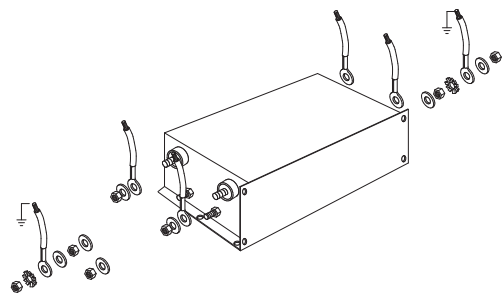

**MECHANICAL DIMENSIONS mm**

FIN1220	A	B	C	d	d1	d2	d3	d4	V	F	H	I	L	N	N1	P	S	Weight Kg.	Case
.280.B.0V	90	220	120	M8	M10	6	20	M10	42	6.5	356	320	340	50	190	70	55	7.5	7
.320.B.0V	90	220	120	M8	M10	6	20	M10	42	6.5	356	320	340	50	190	70	55	7.5	7
.360.B.0V	130	230	150	M8	M10	10	25	M10	42	6.5	420	380	400	70	200	85	85	10	8
.400.B.0V	130	230	150	M8	M10	10	25	M10	42	6.5	420	380	400	70	200	85	85	10	8
.500.B.0V	130	230	150	M8	M10	10	25	M10	42	6.5	420	380	400	70	200	85	85	10	8
.600.B.0V	130	230	150	M10	M10	15	30	M10	48	6.5	510	450	480	70	200	100	85	15.5	9
.750.B.0V	130	230	150	M10	M10	15	30	M10	48	6.5	510	450	480	70	200	100	85	15.5	9
.900.B.0V	160	250	140	M12	M12	20	40	M12	94	8.5	510	450	480	70	200	110	110	23	10
.1000.B.0V	160	250	140	M12	M12	20	40	M12	94	8.5	510	450	480	70	200	110	110	23	10
.1250.B.0V	160	250	140	M12	M12	20	40	M12	94	8.5	510	450	480	70	200	110	110	23	10
.1500.B.0V	180	300	200	M12	M12	20	60	M12	97	8.5	560	500	530	80	250	130	117	27	11
.1600.B.0V	180	300	200	M12	M12	20	60	M12	97	8.5	560	500	530	80	250	130	117	27	11
.1750.B.0V	180	300	200	M12	M12	20	60	M12	97	8.5	560	500	530	80	250	130	117	27	11
.2000.B.0V	225	350	200	M12	M12	25	80	M12	100	8.5	610	550	580	150	-	-	112.5	45	12
.2250.B.0V	225	350	200	M12	M12	25	80	M12	100	8.5	610	550	580	150	-	-	112.5	45	12
.2500.B.0V	225	350	200	M12	M12	25	80	M12	100	8.5	610	550	580	150	-	-	112.5	45	12
.3000.B.0V	225	350	200	M12	M12	25	80	M12	100	8.5	610	550	580	150	-	-	112.5	45	12

**CASE 7, 8, 9**

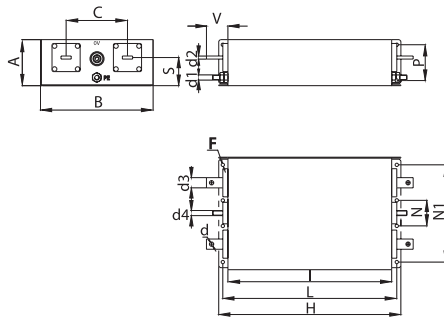

**ASSEMBLY CONNECTION "B"**

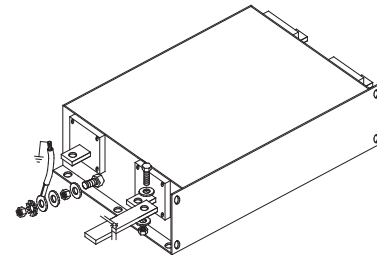

**CASE 10, 11**

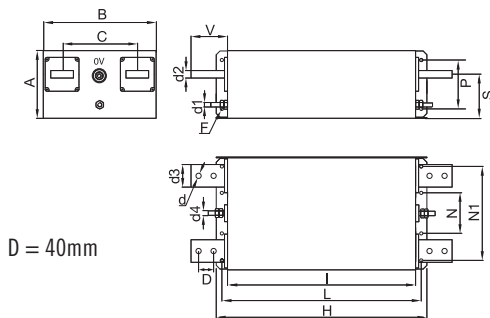

**ASSEMBLY CONNECTION "B"**

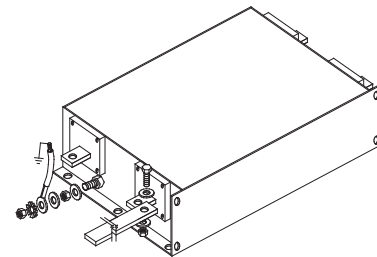

**CASE 12**

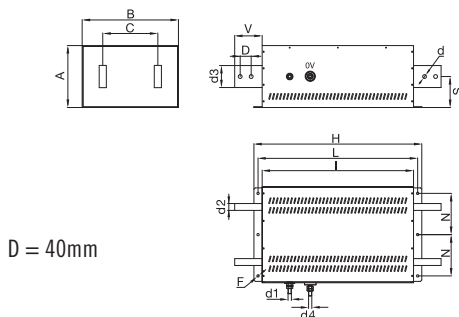

**ASSEMBLY CONNECTION "B"**

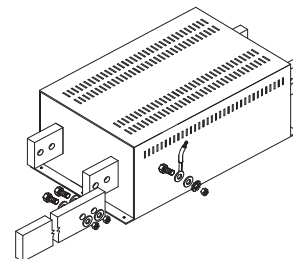



## EMI/RFI DC Filter with excellent attenuation performance for DC industrial applications

Datasheet 3/2019

### APPROVALS:



UL1283  
CSA C22.2

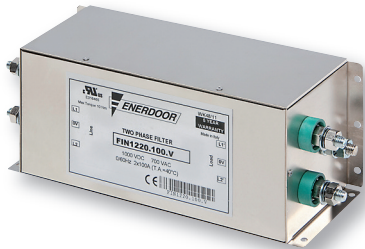

**FIN1520.(005 - 280).V**



**FIN1520.(280 - 1750).B**



**FIN1520.(2000 - 3000).B**

### FEATURES

- Rated current from 5 to 3000A
- Excellent common mode attenuation
- Low leakage current

### BENEFITS

- 5 Year warranty
- Compact case
- Voltage spike reduction

### MARKETS

- Renewable energy
- Recharging stations
- AC/DC converters
- Single phase machines up to 700 Vac

### ORDERING CODE

FIN1520	.100	.V
Model	Current (A)	Connection
		V = Screw
		B = Bus bar

### ATTENUATION INDICATOR

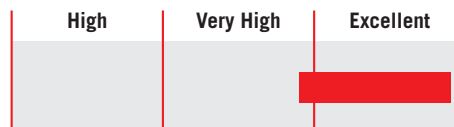

### ELECTRIC DIAGRAM

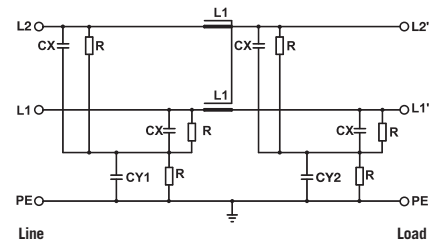

### TECHNICAL SPECIFICATIONS

Nominal voltage	0 / 1000 Vdc - 0 / 700 Vac
Frequency	50 – 60 Hz
Rated current	5 to 3000A
Potential test voltage phase to phase	3100 Vdc (2 sec.)
Potential test voltage phase to ground	3400 Vdc (2 sec.)
Leakage current normal conditions	<10 mA *
Leakage current worst conditions	<80 mA
IP Protection	IP20 up to 280A IP00 over 280A IP20 available with protection FINPRT
Overload capability	4 x Rated current (Switch ON) 2 x In 10 seconds 1.5 In for 10 minutes
Climatic class	-40 / +85° C
MTBF at 40°C	250.000 Hrs

\* Voltage 230 Vac phase to ground 50Hz / 40°C

### ELECTRICAL CHARACTERISTICS

FIN1520	Rated Current 40°C	Rated Current 50°C	Power Loss (W)
.005.V	5	4	5
.010.V	10	8	7
.016.V	16	14	14
.030.V	30	27	11
.050.V	50	46	10
.080.V	80	75	39
.100.V	100	90	45
.130.V	130	110	49
.150.V	150	140	69
.180.V	180	165	77
.200.V	200	190	85
.250.V	272	250	87
.280.V	297	280	77
.280.B	330	320	76
.320.B	330	320	77
.360.B	390	360	98
.400.B	435	400	102
.500.B	545	500	96
.600.B	654	600	102
.750.B	800	750	88
.900.B	940	900	72
.1000.B	1050	1000	102
.1250.B	1290	1250	96
.1500.B	1550	1500	108
.1600.B	1650	1600	115
.1750.B	1800	1750	120
.2000.B	2050	2000	122
.2250.B	2300	2250	127
.2500.B	2550	2500	140
.3000.B	3000	2950	150

### CONNECTIONS

LINE		PE	
d (mm)	Torque (Nm)	d1 (mm)	Torque (Nm)
M4	1.2	M4	1.2
M4	1.2	M4	1.2
M5	4	M5	4
M5	4	M5	4
M6	6	M5	4
M8	14	M8	14
M8	14	M8	14
M10	18	M10	18
M10	18	M10	18
M10	18	M10	18
M10	18	M10	18
M12	20	M10	18
M12	20	M10	18
M8	14	M10	18
M8	14	M10	18
M8	14	M10	18
M8	14	M10	18
M10	25	M10	18
M10	25	M10	18
M12	50	M12	20
M12	50	M12	20
M12	50	M12	20
M12	50	M12	20
M12	50	M12	20
M12	50	M12	20
M12	50	M12	20
M12	50	M12	20
M12	50	M12	20
M12	50	M12	20

### TYPICAL ATTENUATION

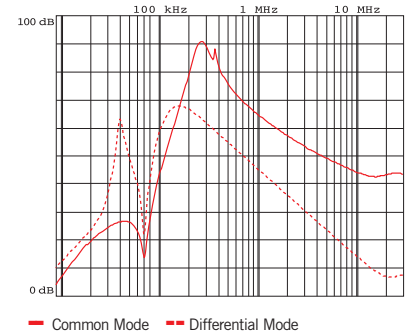

Typical attenuation 5A - 400A

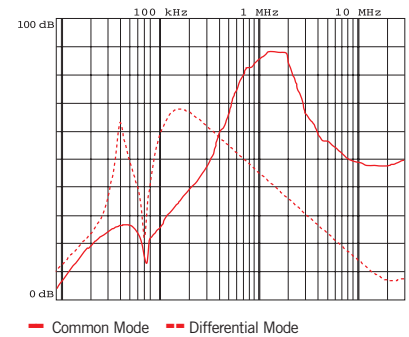

Typical attenuation 500A - 3000A

## MECHANICAL DIMENSIONS mm

FIN1520	A	B	C	d	d1	V	F	H	I	L	N	P	S	Weight Kg.	Case
.005.V	58	86	44	M4	M4	14	4.5	186	160	176	30	40	38	2	1
.010.V	58	86	44	M4	M4	14	4.5	186	160	176	30	40	38	2	1
.016.V	90	100	46	M5	M5	28	4.5	246	220	235	35	70	64	3	2
.030.V	90	100	46	M5	M5	28	4.5	246	220	235	35	70	64	3	2
.050.V	90	100	46	M6	M5	28	4.5	246	220	235	35	70	64	3	3
.080.V	90	100	40	M8	M8	28	4.5	246	220	235	35	70	69	3	4
.100.V	90	100	40	M8	M8	28	4.5	246	220	235	35	70	69	3	4
.130.V	90	185	120	M10	M10	29	6.5	356	320	340	77.5	70	60	5	5
.150.V	90	185	120	M10	M10	29	6.5	356	320	340	77.5	70	60	5	5
.180.V	90	185	120	M10	M10	29	6.5	356	320	340	77.5	70	60	5	5
.200.V	90	185	120	M10	M10	29	6.5	356	320	340	77.5	70	60	5	5
.250.V	90	220	120	M12	M10	30	6.5	356	320	340	95	70	60	7.5	6
.280.V	90	220	120	M12	M10	30	6.5	356	320	340	95	70	60	7.5	6

### CASE 1, 2, 3, 4

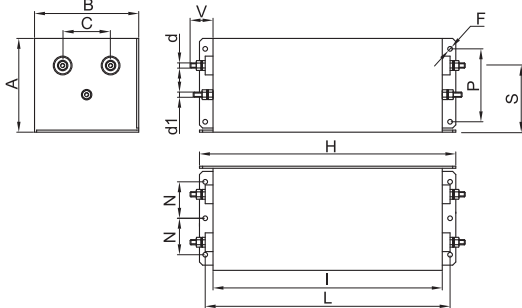

### ASSEMBLY CONNECTION "V"

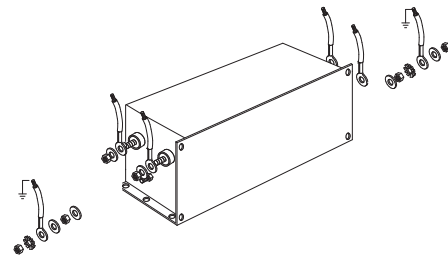

### CASE 5, 6

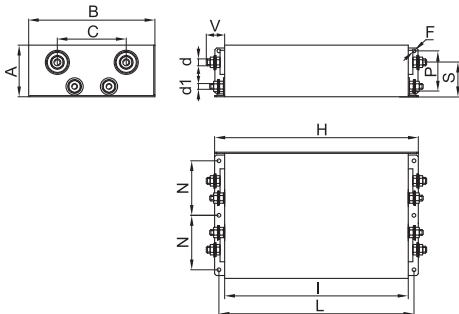

### ASSEMBLY CONNECTION "V"

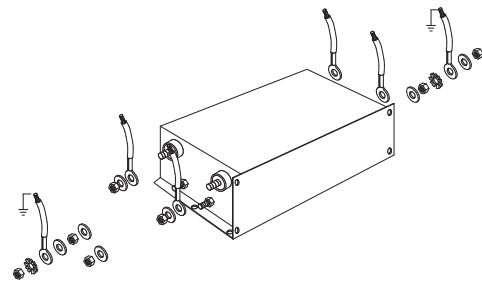

## MECHANICAL DIMENSIONS mm

FIN1520	A	B	C	d	d1	d2	d3	V	F	H	I	L	N	N1	P	S	Weight Kg.	Case
.280.B	90	220	120	M8	M10	6	20	42	6.5	356	320	340	50	190	70	55	7.5	7
.320.B	90	220	120	M8	M10	6	20	42	6.5	356	320	340	50	190	70	55	7.5	7
.360.B	130	230	150	M8	M10	10	25	42	6.5	420	380	400	70	200	85	85	10	8
.400.B	130	230	150	M8	M10	10	25	42	6.5	420	380	400	70	200	85	85	10	8
.500.B	130	230	150	M8	M10	10	25	42	6.5	420	380	400	70	200	85	85	10	8
.600.B	130	230	150	M10	M10	15	30	48	6.5	510	450	480	70	200	100	85	15.5	9
.750.B	130	230	150	M10	M10	15	30	48	6.5	510	450	480	70	200	100	85	15.5	9
.900.B	160	250	140	M12	M12	20	40	94	8.5	510	450	480	70	200	110	110	23	10
.1000.B	160	250	140	M12	M12	20	40	94	8.5	510	450	480	70	200	110	110	23	10
.1250.B	160	250	140	M12	M12	20	40	94	8.5	510	450	480	70	200	110	110	23	10
.1500.B	180	300	200	M12	M12	20	60	97	8.5	560	500	530	80	250	130	117	27	11
.1600.B	180	300	200	M12	M12	20	60	97	8.5	560	500	530	80	250	130	117	27	11
.1750.B	180	300	200	M12	M12	20	60	97	8.5	560	500	530	80	250	130	117	27	11
.2000.B	225	350	200	M12	M12	25	80	100	8.5	610	550	580	150	-	-	112.5	45	12
.2250.B	225	350	200	M12	M12	25	80	100	8.5	610	550	580	150	-	-	112.5	45	12
.2500.B	225	350	200	M12	M12	25	80	100	8.5	610	550	580	150	-	-	112.5	45	12
.3000.B	225	350	200	M12	M12	25	80	100	8.5	610	550	580	150	-	-	112.5	45	12

### CASE 7, 8, 9

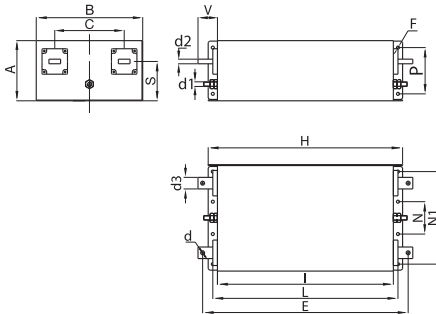

### ASSEMBLY CONNECTION "B"

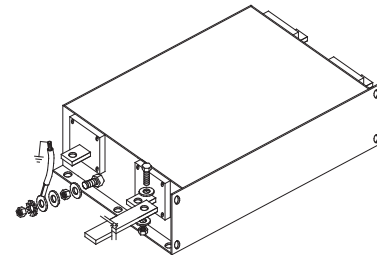

### CASE 10, 11

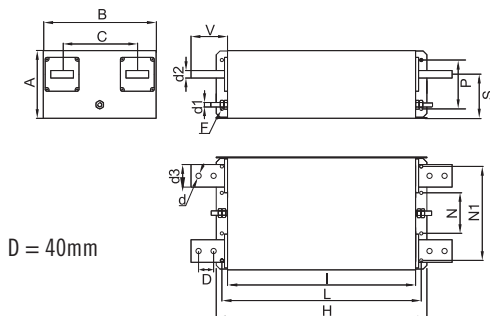

### ASSEMBLY CONNECTION "B"

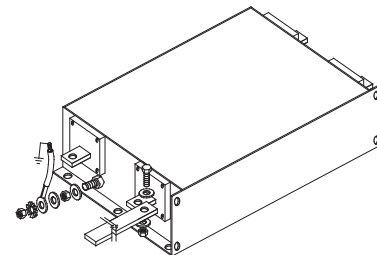

### CASE 12

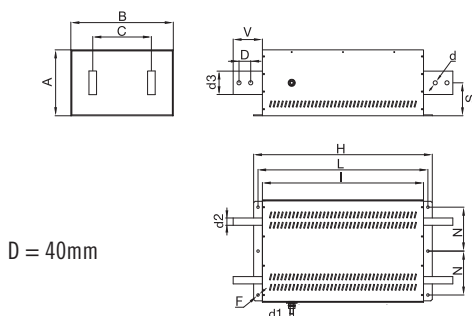

### ASSEMBLY CONNECTION "B"

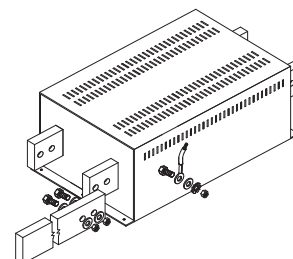



## EMI/RFI DC Filter with excellent attenuation and zero volt insulated option for DC industrial applications

Datasheet 3/2019

### APPROVALS:



SCCR by UL508A

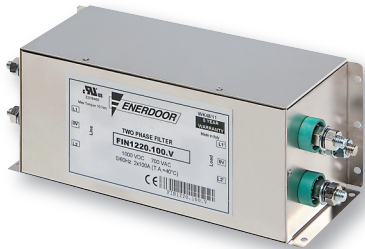

**FIN1520.(005 – 280).V.0V**

### FEATURES

- Rated current from 5 to 3000A
- Excellent common mode attenuation
- Low leakage current

### BENEFITS

- 5 Year warranty
- Various connections available
- Zero volt connector for PE floating systems



**FIN1520.(280 - 1750).B.0V**

### MARKETS

- Renewable energy
- AC/DC converters
- Single phase machines up to 700 Vac

### ORDERING CODE

FIN1520	.100	.V	.0V
Model	Current (A)	Connection	PE insulated
		V = Screw	
		B = Bus bar	



**FIN1520.(2000 - 3000).B.0V**

Vertical bus bar connections available upon request

### ATTENUATION INDICATOR

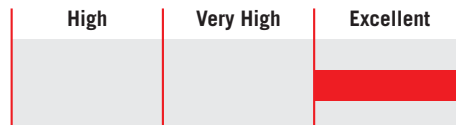

### ELECTRIC DIAGRAM

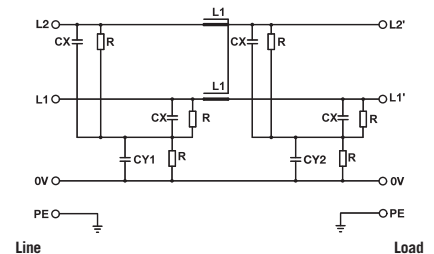

### TECHNICAL SPECIFICATIONS

Nominal voltage	0 / 1000 Vdc - 0 / 700 Vac
Frequency	50 – 60 Hz
Rated current	5 to 3000A
Potential test voltage phase to phase	3100 Vdc (2 sec.)
Potential test voltage phase to ground	3400 Vdc (2 sec.)
Leakage current normal conditions	< 10 mA *
Leakage current worst conditions	< 80 mA
IP Protection	IP20 up to 280A IP00 over 280A IP20 available with protection FINPRT
Overload capability	4 x Rated current (Switch ON) 2 x In 10 seconds 1.5 In for 10 minutes
Climatic class	-40 / +85° C
MTBF at 40°C	250.000 Hrs

\* Voltage 230 Vac phase to ground 50Hz / 40°C



### ELECTRICAL CHARACTERISTICS

FIN1520	Rated Current 40°C	Rated Current 50°C	Power Loss (W)
.005.V.OV	5	4	5
.010.V.OV	10	8	7
.016.V.OV	16	27	14
.030.V.OV	30	46	11
.050.V.OV	50	75	10
.080.V.OV	80	90	39
.100.V.OV	100	110	45
.130.V.OV	130	140	49
.150.V.OV	150	165	69
.180.V.OV	200	190	77
.200.V.OV	210	200	85
.250.V.OV	272	250	87
.280.V.OV	297	280	77
.280.B.OV	330	320	76
.320.B.OV	330	320	77
.360.B.OV	390	360	98
.400.B.OV	435	400	102
.500.B.OV	545	500	96
.600.B.OV	654	600	102
.750.B.OV	800	750	88
.900.B.OV	940	900	72
.1000.B.OV	1050	1000	102
.1250.B.OV	1290	1250	96
.1500.B.OV	1550	1500	108
.1600.B.OV	1650	1600	115
.1750.B.OV	1800	1750	120
.2000.B.OV	2050	2000	122
.2250.B.OV	2300	2250	127
.2500.B.OV	2550	2500	140
.3000.B.OV	3000	2950	150

### CONNECTIONS

LINE		PE		OV	
d (mm)	Torque (Nm)	d1 (mm)	Torque (Nm)	d4 (mm)	Torque (Nm)
M4	1.2	M4	1.2	M4	1.2
M4	1.2	M4	1.2	M4	1.2
M5	4	M5	4	M5	4
M5	4	M5	4	M5	4
M6	6	M5	4	M5	4
M8	14	M8	14	M6	6
M8	14	M8	14	M6	6
M10	18	M10	18	M10	18
M10	18	M10	18	M10	18
M10	18	M10	18	M10	18
M10	18	M10	18	M10	18
M12	20	M10	18	M10	18
M12	20	M10	18	M10	18
M8	14	M10	18	M10	18
M8	14	M10	18	M10	18
M8	14	M10	18	M10	18
M8	14	M10	18	M10	18
M8	14	M10	18	M10	18
M10	25	M10	18	M10	18
M10	25	M10	18	M10	18
M12	50	M12	20	M12	20
M12	50	M12	20	M12	20
M12	50	M12	20	M12	20
M12	50	M12	20	M12	20
M12	50	M12	20	M12	20
M12	50	M12	20	M12	20
M12	50	M12	20	M12	20
M12	50	M12	20	M12	20
M12	50	M12	20	M12	20
M12	50	M12	20	M12	20
M12	50	M12	20	M12	20

### TYPICAL ATTENUATION

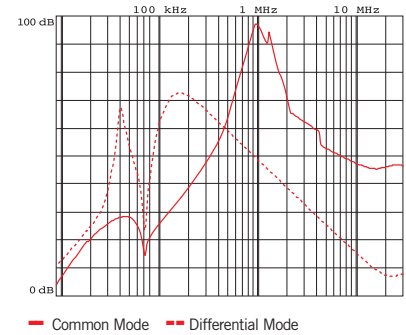

Typical attenuation 5A - 400A

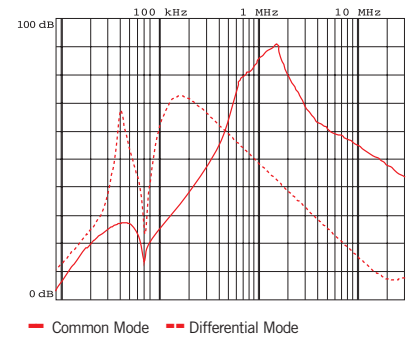

Typical attenuation 500A - 3000A

## MECHANICAL DIMENSIONS mm

FIN1520	A	B	C	d	d1	d4	V	F	H	I	L	N	P	S	Weight Kg.	Case
.005.V.0V	58	86	44	M4	M4	M4	14	4.5	186	160	176	30	40	38	2	1
.010.V.0V	58	86	44	M4	M4	M4	14	4.5	186	160	176	30	40	38	2	1
.016.V.0V	90	100	46	M5	M5	M5	28	4.5	246	220	235	35	70	64	3	2
.030.V.0V	90	100	46	M5	M5	M5	28	4.5	246	220	235	35	70	64	3	2
.050.V.0V	90	100	46	M6	M5	M5	28	4.5	246	220	235	35	70	64	3	3
.080.V.0V	90	100	40	M8	M8	M6	28	4.5	246	220	235	35	70	69	3	4
.100.V.0V	90	100	40	M8	M8	M6	28	4.5	246	220	235	35	70	69	3	4
.130.V.0V	90	185	120	M10	M10	M10	29	6.5	356	320	340	77.5	70	60	5	5
.150.V.0V	90	185	120	M10	M10	M10	29	6.5	356	320	340	77.5	70	60	5	5
.180.V.0V	90	185	120	M10	M10	M10	29	6.5	356	320	340	77.5	70	60	5	5
.200.V.0V	90	185	120	M10	M10	M10	29	6.5	356	320	340	77.5	70	60	5	5
.250.V.0V	90	220	120	M12	M10	M10	30	6.5	356	320	340	95	70	60	7.5	6
.280.V.0V	90	220	120	M12	M10	M10	30	6.5	356	320	340	95	70	60	7.5	6

### CASE 1, 2, 3, 4

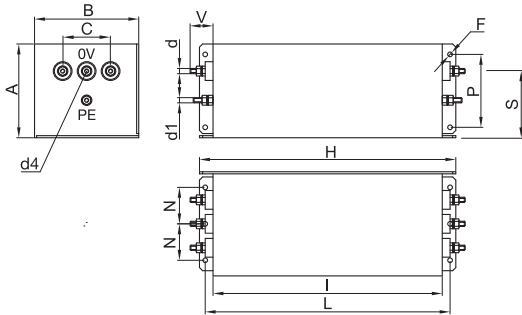

### ASSEMBLY CONNECTION "V"

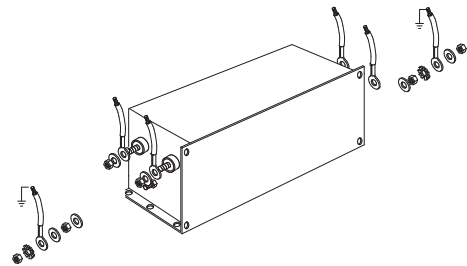

### CASE 5, 6

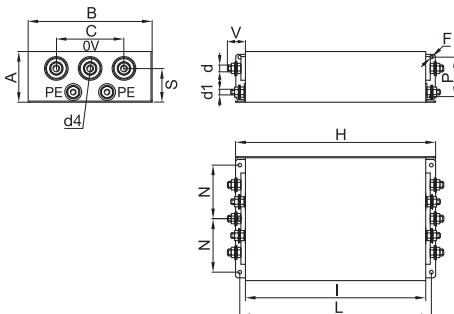

### ASSEMBLY CONNECTION "V"

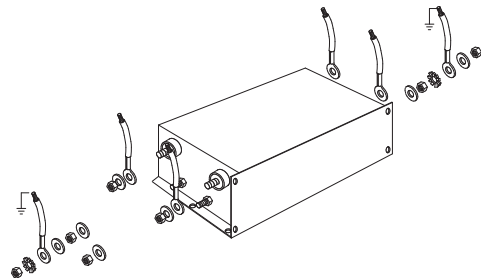

**MECHANICAL DIMENSIONS mm**

FIN1520	A	B	C	d	d1	d2	d3	d4	V	F	H	I	L	N	N1	P	S	Weight Kg.	Case
.280.B.0V	90	220	120	M8	M10	6	20	M10	42	6.5	356	320	340	50	190	70	55	7.5	7
.320.B.0V	90	220	120	M8	M10	6	20	M10	42	6.5	356	320	340	50	190	70	55	7.5	7
.360.B.0V	130	230	150	M8	M10	10	25	M10	42	6.5	420	380	400	70	200	85	85	10	8
.400.B.0V	130	230	150	M8	M10	10	25	M10	42	6.5	420	380	400	70	200	85	85	10	8
.500.B.0V	130	230	150	M8	M10	10	25	M10	42	6.5	420	380	400	70	200	85	85	10	8
.600.B.0V	130	230	150	M10	M10	15	30	M10	48	6.5	510	450	480	70	200	100	85	15.5	9
.750.B.0V	130	230	150	M10	M10	15	30	M10	48	6.5	510	450	480	70	200	100	85	15.5	9
.900.B.0V	160	250	140	M12	M12	20	40	M12	94	8.5	510	450	480	70	200	110	110	23	10
.1000.B.0V	160	250	140	M12	M12	20	40	M12	94	8.5	510	450	480	70	200	110	110	23	10
.1250.B.0V	160	250	140	M12	M12	20	40	M12	94	8.5	510	450	480	70	200	110	110	23	10
.1500.B.0V	180	300	200	M12	M12	20	60	M12	97	8.5	560	500	530	80	250	130	117	27	11
.1600.B.0V	180	300	200	M12	M12	20	60	M12	97	8.5	560	500	530	80	250	130	117	27	11
.1750.B.0V	180	300	200	M12	M12	20	60	M12	97	8.5	560	500	530	80	250	130	117	27	11
.2000.B.0V	225	350	200	M12	M12	25	80	M12	100	8.5	610	550	580	150	-	-	112.5	45	12
.2250.B.0V	225	350	200	M12	M12	25	80	M12	100	8.5	610	550	580	150	-	-	112.5	45	12
.2500.B.0V	225	350	200	M12	M12	25	80	M12	100	8.5	610	550	580	150	-	-	112.5	45	12
.3000.B.0V	225	350	200	M12	M12	25	80	M12	100	8.5	610	550	580	150	-	-	112.5	45	12

**CASE 7, 8, 9**

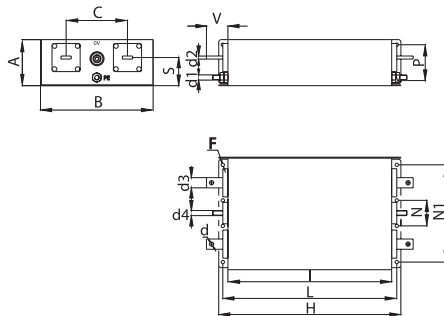

**ASSEMBLY CONNECTION "B"**

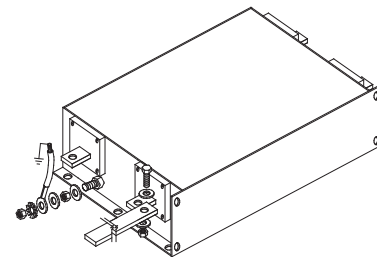

**CASE 10, 11**

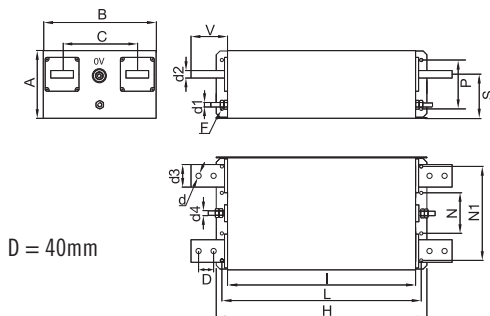

**ASSEMBLY CONNECTION "B"**

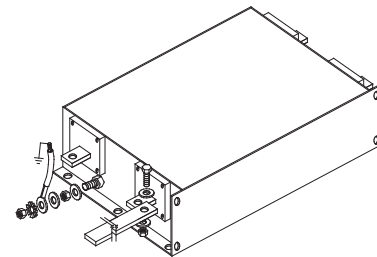

**CASE 12**

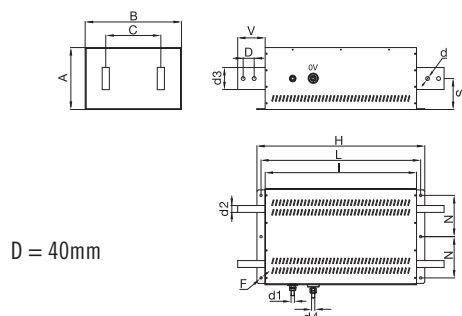

**ASSEMBLY CONNECTION "B"**

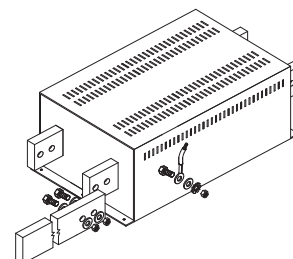



## EMI/RFI DC Filter with excellent attenuation for DC industrial applications

Datasheet 3/2019

**APPROVALS:**

**FIN7212.(150 - 2000).B**

Models available with current ratings up to 3000A upon request

**FEATURES**

- Rated current from 150 to 2000A
- Excellent differential and common mode attenuation
- Low leakage current

**MARKETS**

- Electrical equipment
- Machine tools
- Industrial automation
- Variable frequency drives / servo drives
- Regenerative systems
- Renewable energy

**BENEFITS**

- 5 Year warranty
- Very compact case
- Finger safe protection available
- Zero volt insulated model available

**ORDERING CODE**

FIN7212	.100	.B	.0V
Model	Current (A)	Connection	zero volt connection optional
		B = Bus bar	

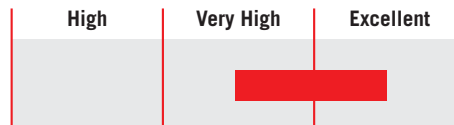
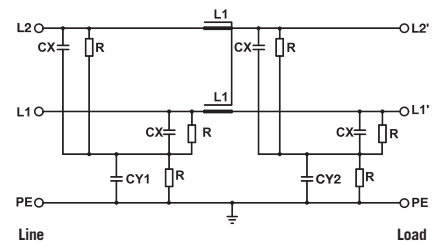
**ATTENUATION INDICATOR**

**ELECTRIC DIAGRAM**

**TECHNICAL SPECIFICATIONS**

	<b>FIN7212</b>
Nominal voltage	0 / 1000 Vdc - 0 / 700 Vac
Frequency	50 – 60 Hz
Rated current	150 to 2000A
Potential test voltage phase to phase	2400 Vdc (2 sec.)
Potential test voltage phase to ground	3200 Vdc (2 sec.)
Leakage current normal conditions	< 10 mA
Leakage current worst conditions	< 35 mA *
IP Protection	IPO0 over
Overload capability	4 x Rated current (Switch ON) 2 x In 10 seconds 1.5 In for 10 minutes
Climatic class	-40 / +85° C
MTBF at 40°C	250.000 Hrs

\* Voltage 230 Vac phase to ground 50Hz / 40°C

### ELECTRICAL CHARACTERISTICS

FIN7212	Rated Current 40°C	Rated Current 50°C	Power Loss (W)
.150.B	150	135	65
.200.B	200	180	70
.280.B	280	250	75
.320.B	320	290	80
.360.B	360	325	90
.400.B	400	360	110
.500.B	500	450	102
.600.B	600	540	95
.750.B	750	675	80
.800.B	800	720	82
.900.B	900	810	90
.1000.B	1000	900	100
.1250.B	1250	1120	105
.1500.B	1500	1350	110
.1750.B	1750	1500	125
.2000.B	2000	1750	132

### CONNECTIONS

LINE		PE	
d (mm)	Torque (Nm)	d1 (mm)	Torque (Nm)
M8	14	M8	14
M8	14	M8	14
M8	14	M8	14
M8	14	M8	14
M8	14	M8	14
M8	14	M8	14
M8	14	M8	14
M10	18	M8	14
M10	18	M8	14
M10	18	M8	14
M10	18	M8	14
M10	18	M8	14
M10	18	M8	14
M10	18	M8	14
M10	18	M8	14
M10	18	M8	14
M10	18	M8	14

### TYPICAL ATTENUATION

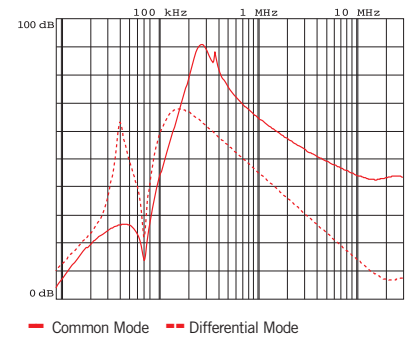

Typical attenuation 150A - 2000A

### MECHANICAL DIMENSIONS mm

FIN7212	A	B	C	D	E	H	I	L	N	P	S	d	d2	Weight Kg.	Case
.150.B	86	200	120	300	227	300	240	275	165	320	37	9	20x6	4.5	1
.200.B	86	200	120	300	227	300	240	275	165	320	37	9	20x6	4.6	1
.280.B	86	200	120	300	227	300	240	275	165	320	37	9	20x6	4.7	1
.320.B	86	200	120	300	227	300	240	275	165	320	37	9	20x6	4.75	1
.360.B	86	200	120	300	227	300	240	275	165	320	37	9	20x6	4.8	1
.400.B	86	200	120	300	227	300	240	275	165	320	37	9	20x6	4.8	1
.500.B	125	200	120	295	222	300	240	275	200	320	62.5	11	35x10	7.7	2
.600.B	125	200	120	295	222	300	240	275	200	320	62.5	11	35x10	7.8	2
.750.B	125	200	120	295	222	300	240	275	200	320	62.5	11	35x10	7.95	2

### CASE 1, 2

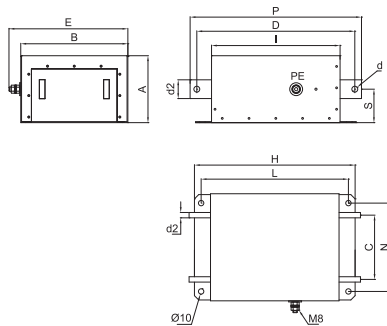

### ASSEMBLY CONNECTION "B"

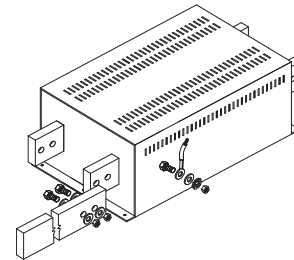

### MECHANICAL DIMENSIONS mm

FIN7212	A	B	C	D	E	H	I	L	N	P	S	T	d	d2	Weight Kg.	Case
.800.B	200	250	140	380	277	300	310	280	278	460	-	430	11	50x10	15	3
.900.B	200	250	140	380	277	300	310	280	278	460	-	430	11	50x10	15	3
.1000.B	200	250	140	380	277	300	310	280	278	460	-	430	11	60x10	16	4
.1250.B	200	250	140	380	277	300	310	280	278	460	-	430	11	60x10	17	4

### CASE 3, 4

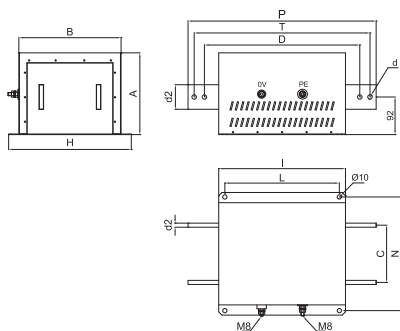

### ASSEMBLY CONNECTION "B"

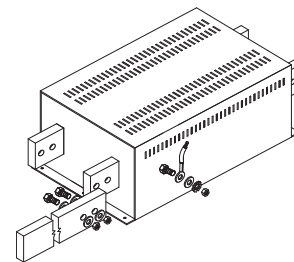

### MECHANICAL DIMENSIONS mm

FIN7212	A	B	C	D	H	I	L	N	K	P	T	d	d2	Weight Kg.	Case
.1500.B	200	250	140	380	300	310	280	278	460	430	405	11	70x10	22	5
.1750.B	200	250	140	380	300	310	280	278	460	430	405	11	80x10	25	5
.2000.B	200	250	140	380	300	310	280	278	460	430	405	11	80x10	26	5

### CASE 5

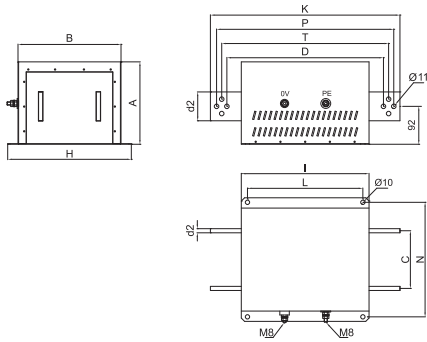

### ASSEMBLY CONNECTION "B"

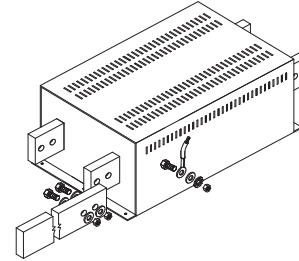

## Introduction

Power quality is a significant concern for today's manufacturing and power generation facilities. Finding the right solution for unbalanced loads is important. Two major power quality issues are harmonic distortion and reactive power generated by a low power factor.

Devices such as variable frequency drives, servo drives, LED light drivers and other devices that rectify AC to DC can generate harmonic distortion. It is important to limit the distortion under a certain level in order to reduce effects on other equipment in a facility.

Reactive power, which may be capacitive or inductive, causes the current waveform to change phases respective to the voltage waveform. The capacitance causes the current to lead and the inductance causes the current to lag.

In power transmission, due to the fact that most loads are inductive, there is more reactive power resulting in extra current being supplied. This leads to power loss and high temperatures with additional cost to the operator. For this reason industries are charged extra if they have a low power factor.

## Harmonic Theory

In a sinusoidal wave it is important to understand when harmonics are generated. The electrical network provides a sinusoidal voltage and the load absorbs a certain current which depends on the impedance of the load itself.

If the response is linear, the relationship between voltage and current is constant. In a resistive load for example, the current wave shape will be identical to the shape of the voltage wave that is sinusoidal and therefore without distortion.

If the load response is not linear, the current waveform will not follow the voltage waveform but will depend on the ratio between voltage and current at each instant. This will therefore result in a non-sinusoidal waveform.

A typical example of a non-linear load is represented by the input rectifier bridge built inside drives.

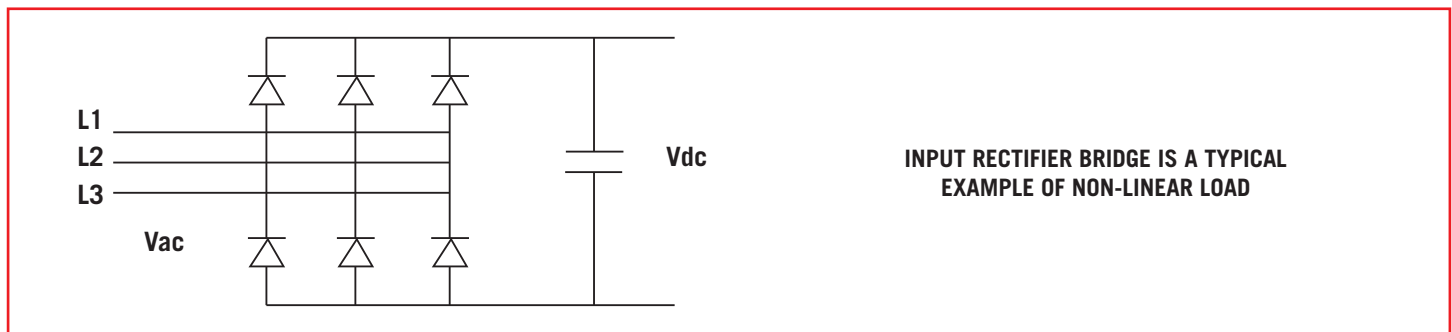

## Harmonic Rating

THD and TDD parameters are used to evaluate harmonic content.

THD or Total Harmonic Distortion is expressed as a percentage and is calculated according to the following formula:

$$THD = \frac{\sqrt{I_2^2 + I_3^2 + I_4^2 + I_5^2 + \dots}}{I_1}$$

Where I1 represents the current at that moment, I2, I3... represent the harmonic currents at that moment.

$$TDD = \frac{\sqrt{I_2^2 + I_3^2 + I_4^2 + I_5^2 + \dots}}{I_r}$$

TDD or Total Demand Distortion is the same as calculating the THD but instead of referring to the fundamental current, it refers to the current Ir which is the rated current of a full load.

The THD is measured by a percentage instant value and has no real indication of the amount of harmonic distortion without knowing the load current absorbed at that particular moment.

The TDD refers to the rated current and gives an immediate indication of the harmonic distortion, as the rated current is a known datum. THD and TDD coincide with the rated current.



## Power Factor

Power factor is defined as a ratio between real power and apparent power in the circuit.

The measured value of power factor is the interval between -1 and 1. A power factor less than one indicates that the voltage and current waveforms are not in phase. A negative power factor occurs when the load generated power flows back to the source.

Typical examples of low power factor are:

- Linear loads: induction motors
- Non-linear loads: rectifiers

In a typical electric power system, a load with low power factor draws more current than a load with higher power factor. Higher current increases energy loss, requiring a larger cable wire and additional solution. For this reason, electrical utilities usually charge a higher price to facilities with low power factor.

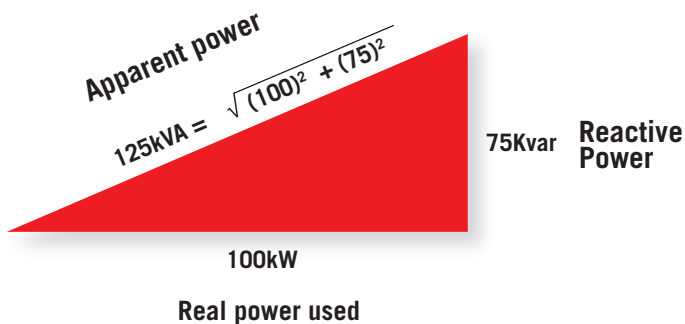

$$\text{Power Factor } \cos\theta = \frac{P, \text{ real power}}{S, \text{ apparent power}}$$

## Problems Generated by Harmonics and Displacement Power Factor

Both harmonic distortion and displacement power cause the following problems in an installation:

- Oversizing of power cables, transformers and generators to support higher currents due to reactive energy
- Voltage harmonic distortion due to an unbalanced load propagated to other loads in the installation
- Disruptive resonance with other reactive components on the same power line
- Higher utility costs due to kVAR returning to the mains
- Communication interference
- Energy loss

## Harmonic Solutions

The Enerdoor devices used to reduce current harmonic distortion are:

- DC chokes
- Line reactors
- Passive or active harmonic filters

Below are typical examples of a non-linear load with current THD % versus Enerdoor solutions.

Technique	Current THD %
No mitigation	50 - 70%
DC Choke	30 - 40%
3% Line reactor + DC choke	30 - 40%
5% Line reactor + DC choke	25 - 35%
Passive harmonic filter	5 - 10%
Active front end	3 - 6%
Active harmonic filter	5%

Enerdoor has developed a series of line reactors and passive and active harmonic filters to meet any type of requirements in terms of harmonic reduction and cost.

Line reactors and passive harmonic filters are recommended for single drive applications and sized by the total current. As an alternative, the active harmonic filter works in parallel and compensates current for single or multiple load applications operating under varied loads. They may be used for single applications or an entire facility.

## Power Factor

The most common solution to compensate power factor correction is a capacitor bank. Capacitance compensates for inductive loads floating the power factor close to 1.

The Enerdoor static var generator is a superior alternative to the capacitor bank. It compensates the power factor using an Insulated Gate Bipolar Transistor (IGBT) instead of traditional capacitor banks. This superior technology is a modular system which may be installed in parallel to the main line.

Major advantages of a static var generator vs traditional capacitor banks:

- Not influenced by harmonic resonance
- Compensates both inductive and capacitive reactive power
- System is active. Voltage from the grid has no influence on the compensation capacity
- Very fast response



Filter Selection Guide	Description	Current Range (A)	Voltage	CONNECTORS			FEATURES					APPLICATIONS					Approval
				Terminal Blocks	Screws	Bus Bar	Additional Power Factor Port	Enclosed	Active Technology	Meets IEC61000-3-12 / IEEE 519	Compact Case	Variable Frequency Drive	Automation	Power Factor Correction	HVAC System	End-User Application	
<b>Harmonic Filters</b>																	
<b>FINFF</b>	3-phase	1-750	0-600	X	X	X					X	X	X				
<b>FINHRM</b>	3-phase	16-200	400-600	X			X	X			X	X	X		X		
<b>FINHRM5</b>	3-phase	10-800	400-600	X	X	X				X		X			X		
<b>FINHRMAD</b>	3-phase 3-phase plus neutral	-	208-690	X				X	X	X	X		X			X	
<b>FINSVG</b>	3-phase 3-phase plus neutral	-	208-690	X			X	X	X					X		X	

The Enerdoor harmonic filter series includes line reactors, passive and active harmonic filters, and static var generators.

Enerdoor line reactors are available with 3% and 5% impedance and with nominal voltage up to 600 Vac.

Enerdoor passive harmonic filter series is available up to 800A with nominal voltage up to 480 Vac. Custom filters are available with voltage up to 690 Vac. This series features different levels of attenuation offering the best solution to meet the EN61000-3-2, EN61000-3-12 and IEEE519 International Standard requirements.

As a standard, the FINHRM5 offers a current range up to 800A and the FINHRM up to 200A. The typical THDI reduction is <5% for the FINHRM5 and <15% for the FINHRM. Neither filter is effected by network impedance. This series is designed to guarantee a power factor greater than 0.9 considering an initial value of 0.7. An additional external capacitor to improve power factor correction may be included, as required.

This series reduces the effects of voltage dips less than 5 ms on the machine performance and reduces flicker emissions.

The Enerdoor active harmonic filter FINHRMAD is a modular design installed in parallel to the power line and reduces harmonics below 5%. This line is available from 230 Vac to 600 Vac with nominal current from 35A to 150A. Features include remote control and wall or panel mount installation.

Enerdoor static var generator FINSVG is a modular design installed in parallel to the power line and compensates reactive power in order to improve power factor.

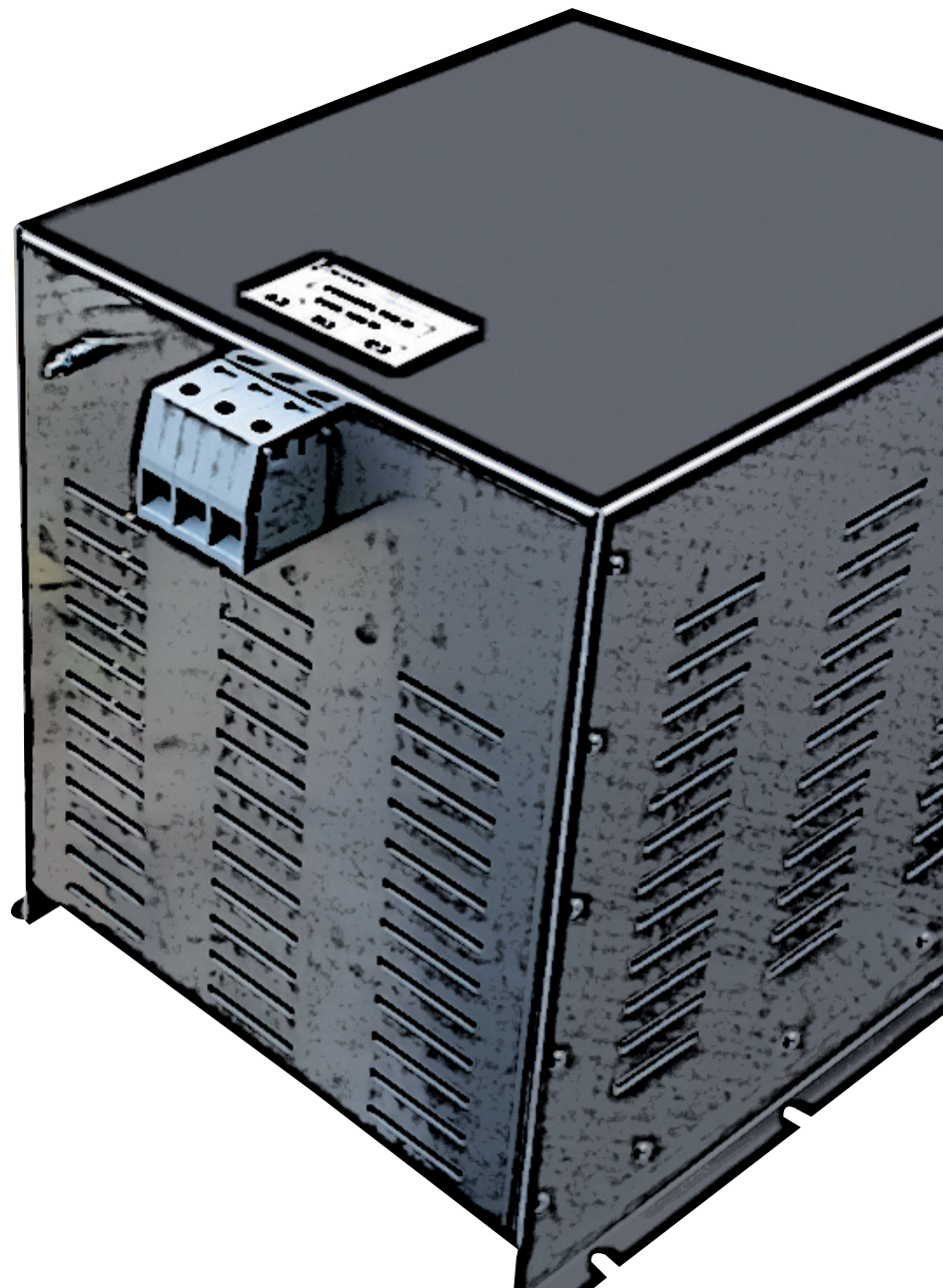



Datasheet 3/2019

## Line reactor 230 Vac, 3% and 5% impedance, with high attenuation of current distortion and overvoltage spikes

**APPROVALS:**

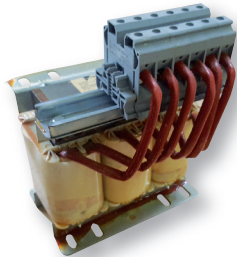
 UL1283  
CSA C22.2

**FINFF (terminal blocks)**
**FEATURES**

- Rated current from 2.5 to 250A
- High differential mode attenuation
- Terminal blocks up to 130A

**BENEFITS**

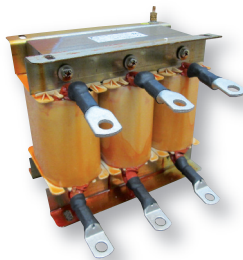
- Various connections available
- Finger safe protection available
- Nema 1 and Nema 3R enclosures

**FINFF (lug connections)**
**MARKETS**

- Variable frequency drives / servo drives
- Automated machinery
- Industrial automation
- Pumps

**ORDERING CODE**

FINFF	020P1	01P1	0831
Model	Inductance (L)	Current (A)	Internal ID
	20.1 mH	1.1A	

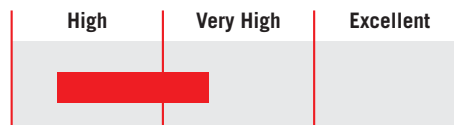
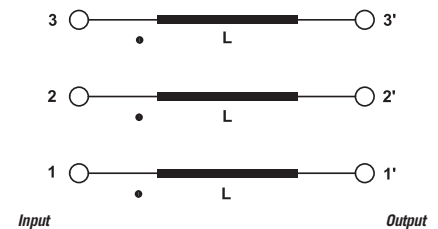
**ATTENUATION INDICATOR**

**ELECTRIC DIAGRAM**

**TECHNICAL SPECIFICATIONS**

Nominal voltage	0 / 600 Vac
Frequency	50 – 60 Hz
Rated current	7 to 250A
Potential test voltage phase to phase	2400 Vdc (2 sec.)
Potential test voltage phase to ground	3200 Vdc (2 sec.)
Saturation current	1.5 x I <sub>n</sub>
Dielectric strength	4 kV
IP Protection	IP20 up to 180A IPO0 over 180A
Climatic class	-40 / +85° C
MTBF at 40°C	250.000 Hrs.

## ELECTRICAL CHARACTERISTICS - MECHANICAL DIMENSIONS

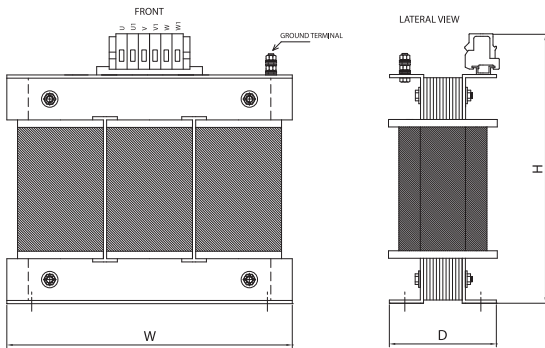
HP@230 Vac	Rated Current 40°C	FF 3% @230Vac	Open Frame Dimensions			Weight (Kg)	Case	Nema 1 Enclosure	FF 5% @230Vac	Open Frame Dimensions			Weight (Kg)	Case	Nema 1 Enclosure
			H	W	D					H	W	D			
0.5	2.4	FF5P05502P11291	120	120	80	1.8	1	FINENCL.31	FF010P602P10829	120	120	90	1.9	1	FINENCL.31
0.75	3.5	FF03P1203P41292	120	120	80	1.8	1	FINENCL.31	FF006P503P40827	120	120	90	2	1	FINENCL.31
1	4.6	FF02P2104P81293	120	120	80	1.9	1	FINENCL.31	FF004P604P80826	120	120	90	2.1	1	FINENCL.31
2	7.6	FF001P407P61294	120	120	90	2.4	1	FINENCL.31	FF02P9107P60832	165	160	120	4	1	FINENCL.31
3	11	FF0P96500111295	160	160	120	3.9	1	FINENCL.31	FF02P0100110833	165	160	120	4	1	FINENCL.31
5	14	FF0P75800141296	160	160	120	4	1	FINENCL.31	FF01P5800140834	165	160	130	4.7	1	FINENCL.31
7	21	FF0P50500211297	160	160	120	4	1	FINENCL.31	FF01P0500210835	165	160	130	5	1	FINENCL.31
10	34	FF0P26500401301	210	160	130	5	1	FINENCL.41	FF00P6400340837	250	180	135	7.6	1	FINENCL.41
15	52	FF0P20500521302	240	180	135	7.5	1	FINENCL.41	FF00P4200520840	250	180	145	9	1	FINENCL.41
25	83	FF0P12800831303	300	240	150	12	1	FINENCL.41	FF0P26800831002	300	240	180	22	1	FINENCL.41
35	105	FF0P10101051304	300	240	150	12.5	1	FINENCL.41	FF0P26301050976	300	240	185	23	1	FINENCL.41
40	130	FF0P08201301305	305	240	165	17	1	FINENCL.41	FF00P1701301003	350	300	190	27	1	FINENCL.41
60	160	FF0P06601601306	210	240	165	17	2	FINENCL.41	FF00P1501600954	300	300	210	29	2	FINENCL.51
70	200	FF0P05302001307	210	240	185	22	2	FINENCL.41	FF0P11102001004	300	220	300	33	2	FINENCL.51
90	250	FF0P04302501308	315	300	230	26	2	FINENCL.51	FF0P08902501005	300	230	300	41	2	FINENCL.51

### CASE 1



### CASE 2

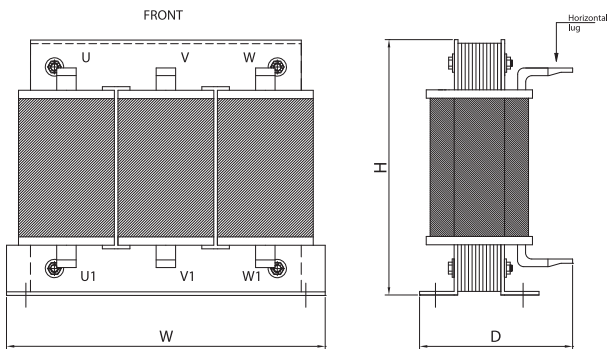



Datasheet 3/2019

**Line reactor 400 Vac, 3% and 5% impedance, with high attenuation of current harmonic distortion and overvoltage spikes**

**APPROVALS:**



UL1283  
CSA C22.2

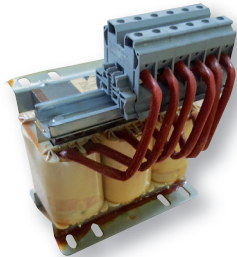

**FINFF (terminal blocks)**

**FEATURES**

- Rated current from 1 to 865A
- High differential mode attenuation
- Terminal blocks up to 180A

**BENEFITS**

- Various connections available
- Finger safe protection upon request
- Nema 1 and Nema 3R enclosures available

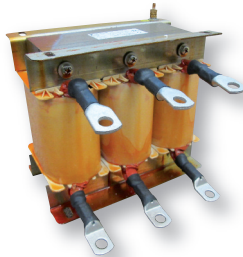

**FINFF (lug connections)**

**MARKETS**

- Variable frequency drives and servo drives
- Automated equipment
- Industrial automation
- Pumps

**ORDERING CODE**

FINFF	4P050	006	1818
Model	Inductance (L)	Current (A)	Internal ID
	4.050 mH	6A	

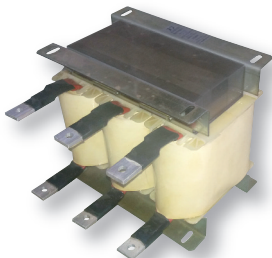

**FINFF (bus bar connections)**

**ATTENUATION INDICATOR**

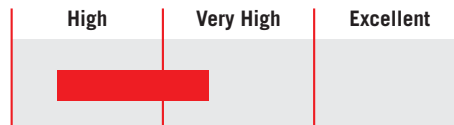

**ELECTRIC DIAGRAM**

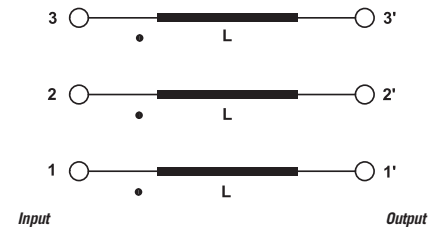

**TECHNICAL SPECIFICATIONS**

Nominal voltage	0 / 750 Vac
Frequency	50 – 60 Hz
Rated current	1 to 865A
Potential test voltage phase to phase	2400 Vdc (2 sec.)
Potential test voltage phase to ground	3200 Vdc (2 sec.)
Saturation current	1.5 x I <sub>n</sub>
Dielectric strength	4 kV
IP Protection	IP20 up to 180A IPO0 over
Climatic class	-40 / +85° C
MTBF at 40°C	250.000 Hrs.



### ELECTRICAL CHARACTERISTICS - MECHANICAL DIMENSIONS

HP@400 Vac	Rated Current 40°C	FF 3% @400Vac	Open Frame Dimensions			Weight (Kg)	Case	Nema 1 Enclosure	FF 5% @400Vac	Open Frame Dimensions			Weight (Kg)	Case	Nema 1 Enclosure
			H	W	D					H	W	D			
3.5	6	FF04P0500061818	120	120	90	2.2	1	FINENCL.31	FF6P7520006	160	160	120	3.3	1	FINENCL.31
8	12	FF2P0250012	160	160	120	3.6	1	FINENCL.31	FF3P3750012	160	160	130	4.5	1	FINENCL.31
11	18	FF1P17200181833	160	160	120	3.7	1	FINENCL.31	FF1P97500181834	160	160	130	4.6	1	FINENCL.31
15	24	FF0P88100241819	180	180	120	5.5	1	FINENCL.31	FF1P4680024	180	180	130	7	1	FINENCL.31
20	32	FF0P660032	180	180	120	6	1	FINENCL.31	FF01P010032	300	240	140	11	1	FINENCL.41
24	38	FF0P63900381820	180	180	135	7.5	1	FINENCL.31	FF1P0660038	300	240	140	11.5	1	FINENCL.41
28	45	FF0P5410045	300	240	140	11	1	FINENCL.41	FF000P90045	300	240	165	15.5	1	FINENCL.41
38	60	FF0P40500601821	300	240	140	11	1	FINENCL.41	FF0P6750060	300	240	165	16.5	1	FINENCL.41
46	73	FF0P3340073	300	240	165	16	1	FINENCL.51	FF0P5550073	300	240	165	17	1	FINENCL.51
57	90	FF0P2670091	300	240	165	16.5	1	FINENCL.51	FF0P4450091	300	240	180	20	1	FINENCL.51
70	110	FF0P22101101822	300	240	165	17	1	FINENCL.51	FF0P3680110	270	300	200	27	1	FINENCL.61
95	150	FF0P16201501826	215	240	250	21	1	FINENCL.61	FF00P2701501828	270	300	210	31	2	FINENCL.61
114	180	FF0P1350180	270	300	200	26	1	FINENCL.61	FF0P2250180	270	300	240	39	2	FINENCL.61
139	220	FF00P1102201827	270	300	200	28	2	FINENCL.61	FF0P1840220	340	340	250	49	2	FINENCL.61
164	260	FF0P0980260	270	300	250	38	2	FINENCL.71	FF0P1620260	340	340	250	52	2	FINENCL.71
196	310	FF0P07803101829	270	300	250	39	2	FINENCL.71	FF0P1310310	340	340	260	60	2	FINENCL.71
234	370	FF0P06006831824	340	340	250	50	3	FINENCL.71	FF0P1090370	340	340	280	82	3	FINENCL.81
290	460	FF0P0540460	340	340	270	61	3	FINENCL.81	FF0P0900460	410	480	300	95	3	FINENCL.81
347	550	FF0P04405501831	340	340	270	63	3	FINENCL.81	FF0P0740550	410	480	300	110	3	FINENCL.81
388	615	FF0P03906161832	340	340	280	80	3	FINENCL.81	FF0P0660616	410	480	330	119	3	FINENCL.101
429	680	FF0P0360683	410	480	300	90	3	FINENCL.101	FF0P06006831824	410	480	320	120	3	FINENCL.101
546	865	FF0P02808661823	410	480	300	100	3	FINENCL.101	FF0P04708661825	650	600	370	173	3	FINENCL.101

#### CASE 1

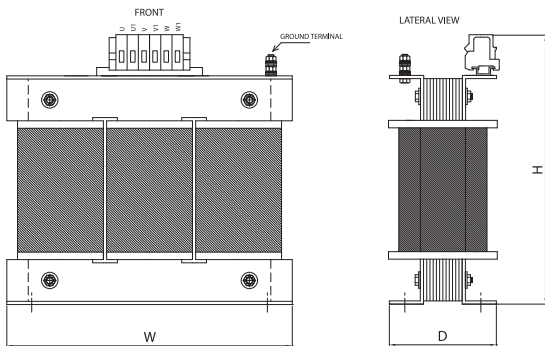

#### CASE 2

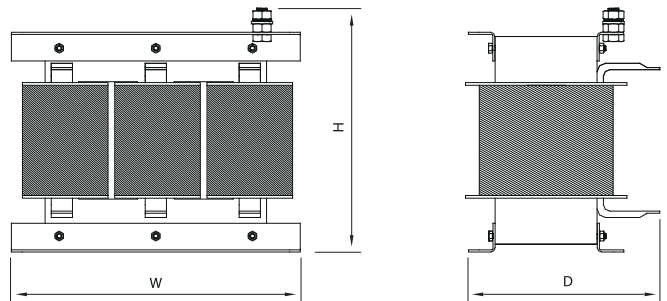

#### CASE 3

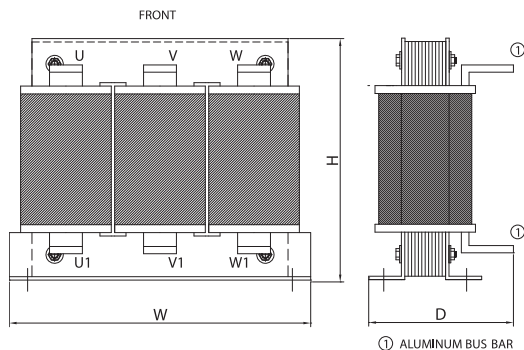



Datasheet 3/2019

**Line reactor 480 Vac, 3% and 5% impedance, with high attenuation of current harmonic distortion and overvoltage spikes**

**APPROVALS:**



UL1283  
CSA C22.2

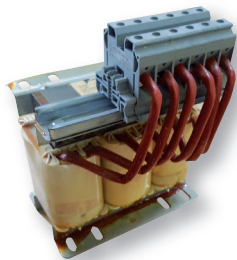

**FINFF (terminal blocks)**

**FEATURES**

- Rated current from 1 to 750A
- High differential mode attenuation
- Terminal blocks up to 180A

**BENEFITS**

- Various connections available
- Finger safe protection available
- Nema 1 and Nema 3R enclosures available

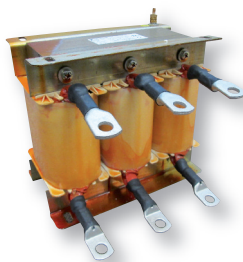

**FINFF (lug connections)**

**MARKETS**

- Variable frequency drives / servo drives
- Automated equipment
- Industrial automation
- Pumps

**ORDERING CODE**

FINFF	020P1	01P1	0831
Model	Inductance (L)	Current (A)	Internal ID
	20.1 mH	1.1A	

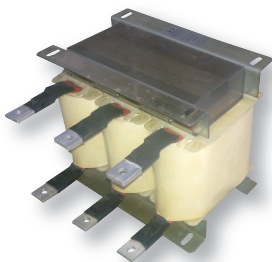

**FINFF (bus-bar connections)**

**ATTENUATION INDICATOR**

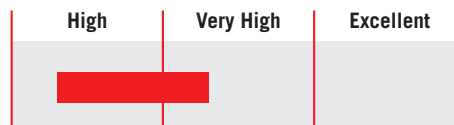

**ELECTRIC DIAGRAM**

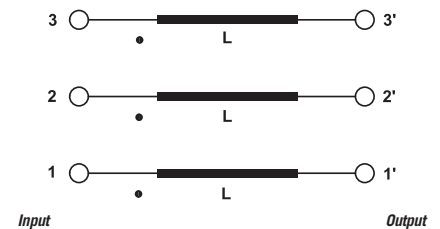

**TECHNICAL SPECIFICATIONS**

Nominal voltage	0 / 750 Vac
Frequency	50 – 60 Hz
Rated current	1 to 750A
Potential test voltage phase to phase	2400 Vdc (2 sec.)
Potential test voltage phase to ground	3200 Vdc (2 sec.)
Saturation current	1.5 x I <sub>n</sub>
Dielectric strength	4 kV
IP Protection	IP20 up to 180A IPO0 over
Climatic class	-40 / +85° C
MTBF at 40°C	250.000 Hrs.



### ELECTRICAL CHARACTERISTICS - MECHANICAL DIMENSIONS

HP@480 Vac	Rated Current 40°C	FF 3% @480Vac	Open Frame Dimensions			Weight (Kg)	Case	Nema 1 Enclosure	FF 5% @480Vac	Open Frame Dimensions			Weight (Kg)	Case	Nema 1 Enclosure
			H	W	D					H	W	D			
0.5	1.1	FF020P101P10831	120	120	90	1.6	1	FINENCL.31	FF033P501P10978	120	120	90	2	1	FINENCL.31
0.75	1.6	FF0013P901P60830	120	120	90	1.85	1	FINENCL.31	FF0002301P60979	120	120	90	2.1	1	FINENCL.31
1	2.1	FF010P602P10829	120	120	90	1.9	1	FINENCL.31	FF0001802P10980	120	120	90	2.5	1	FINENCL.31
2	3.4	FF006P503P40827	120	120	90	2	1	FINENCL.31	FF0001103P40981	120	120	90	2.8	1	FINENCL.31
3	4.8	FF004P604P80826	120	120	90	2.1	1	FINENCL.31	FF007P704P80982	160	160	120	4	1	FINENCL.31
5	7.6	FF02P9107P60832	165	160	120	4	1	FINENCL.31	FF04P8407P60983	160	160	120	4.5	1	FINENCL.31
7.5	11	FF02P0100110833	165	160	120	4	1	FINENCL.31	FF003P300110984	160	160	130	5.3	1	FINENCL.31
10	14	FF01P5800140834	165	160	130	4.7	1	FINENCL.31	FF002P600140985	160	160	130	5.5	1	FINENCL.31
15	21	FF01P0500210835	165	160	130	5	1	FINENCL.31	FF01P7600210986	180	180	130	8	1	FINENCL.31
20	27	FF00P8200340836	250	180	135	7.4	1	FINENCL.31	FF001P300270987	180	180	140	9	1	FINENCL.41
25	34	FF00P6400340837	250	180	135	7.6	1	FINENCL.31	FF001P200340988	300	240	145	12	1	FINENCL.41
30	40	FF00P5500400839	250	180	135	8	1	FINENCL.31	FF00P9800460989	300	240	145	12.5	1	FINENCL.41
40	52	FF00P3400650840	250	180	145	9	1	FINENCL.41	FF00P7500520990	300	240	145	13	1	FINENCL.41
50	65	FF00P3400650841	250	180	145	9	1	FINENCL.41	FFP566300651951	250	240	165	15	1	FINENCL.41
60	83	FF0P26800831002	300	240	150	14	1	FINENCL.41	FF00P5100830991	300	240	180	23	1	FINENCL.41
75	104	FF0P26301050976	300	240	180	22	1	FINENCL.41	FF0P37501040992	350	300	190	28	1	FINENCL.51
100	130	FF00P1701301003	300	240	185	23	1	FINENCL.41	FF000P301300993	350	300	190	28.5	2	FINENCL.51
125	160	FF00P1501600954	350	300	190	27	2	FINENCL.61	FF00P2601600994	300	300	210	33	2	FINENCL.61
150	200	FF0P11102001004	300	300	210	29	2	FINENCL.61	FF000P202000995	300	300	250	41	2	FINENCL.61
200	250	FF0P08902501005	300	300	220	33	2	FINENCL.61	FF0P17702501853	340	395	240	55	2	FINENCL.61
250	322	FFP068703221006	300	300	230	41	3	FINENCL.61	FFP135603251854	340	395	250	62	3	FINENCL.61
300	414	FFP053504141007	375	395	265	56	3	FINENCL.81	FF0P10604151855	340	395	260	80	3	FINENCL.61
400	515	FF0P04305151008	375	395	275	63	3	FINENCL.81	FFP085805151856	340	395	280	90	3	FINENCL.101
475	600	FFP036906001009	375	395	375	67	3	FINENCL.101	FFP073606001857	340	395	280	91	3	FINENCL.101
600	750	FFP029507501010	375	395	300	80	3	FINENCL.101	FF0P04907501858	400	480	350	120	3	FINENCL.101

#### CASE 1

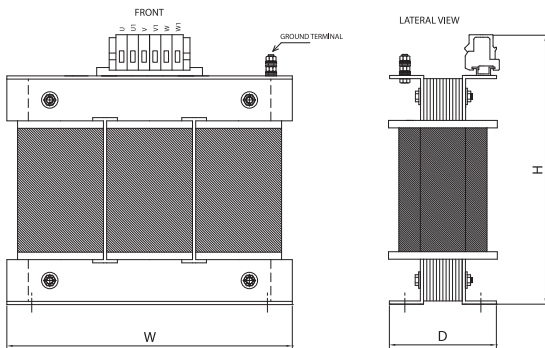

#### CASE 2

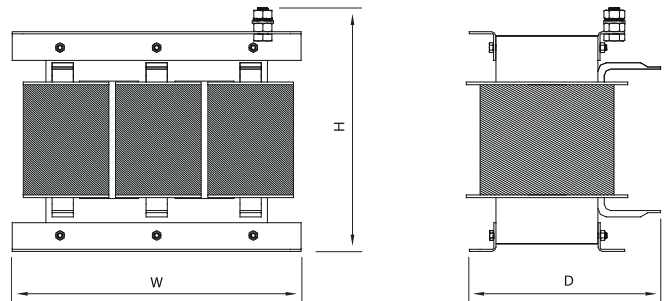

#### CASE 3

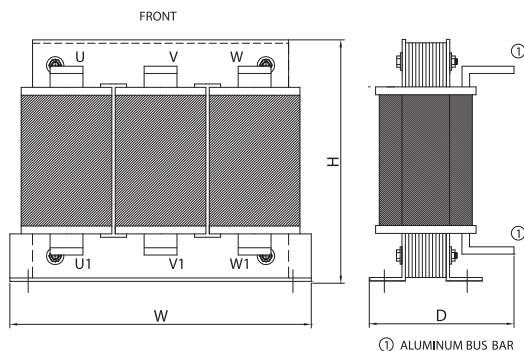



## Passive harmonic filter with very high attenuation of current harmonic distortion and overvoltage spikes

Datasheet 3/2019

**APPROVALS:**

**FINHRM.(016 - 200).M**
**FEATURES**

- Rated current from 16 to 200A
- THDI reduction <15%
- THDI <10% with DC reactor

**BENEFITS**

- 2 Year warranty
- Safety terminal block connectors
- Improves harmonics and flicker

**MARKETS**

- Variable frequency drives
- Woodworking machinery
- Packaging machinery
- Printing machinery

**ORDERING CODE**

FINHRM	.016	.M	010
Model	Current (A)	Connection	
		M = Terminal block	

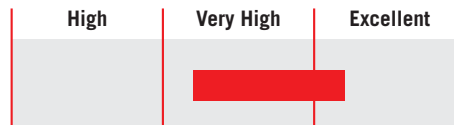
**ATTENUATION INDICATOR**

**TECHNICAL SPECIFICATIONS**

Nominal voltage	400 / 480 Vac ( 600Vac upon request)
Frequency	50 – 60 Hz
Rated current	16 to 200A
Potential test voltage phase to phase	2400 Vdc (2 sec.)
Potential test voltage phase to ground	3200 Vdc (2 sec.)
IP Protection	IP20
Overload capability	4 x Rated current (Switch ON) 2 x In 10 seconds 1.5 In for 10 minutes
Climatic class	-40 / +85° C
MTBF at 40°C	250.000 Hrs

### ELECTRICAL CHARACTERISTICS

FINHRM	Rated Current 40°C	Rated Current 50°C	Power Loss (W)
.016.M	16	12	80
.030.M	30	24	97
.050.M	50	45	170
.075.M	75	68	225
.100.M	100	90	257
.150.M	150	135	320
.200.M	200	180	575
.215.M	218	215	600

### CONNECTIONS

LINE			PE	
Solid Cable (mm <sup>2</sup> )	Stranded Cable (mm <sup>2</sup> )	Terminal Torque (Nm)	d2 (mm)	Torque (Nm)
0.2 - 10	0.2 - 6	1.2	M6	6
0.2 - 10	0.2 - 6	1.2	M6	6
0.2 - 10	0.2 - 6	1.2	M6	6
4 - 25	6 - 35	4.5	M6	6
10 - 50	10 - 50	4	M6	6
35 - 95	35 - 95	20	M6	6
35 - 95	35 - 95	20	M6	6
35 - 95	35 - 95	20	M6	6

### TYPICAL MEASUREMENT

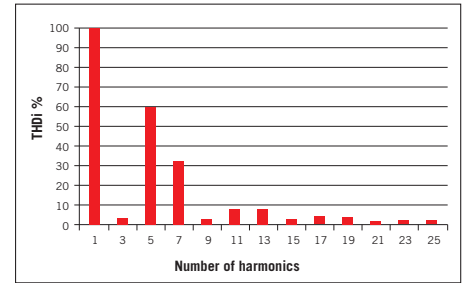

Typical measurement without FINHRM

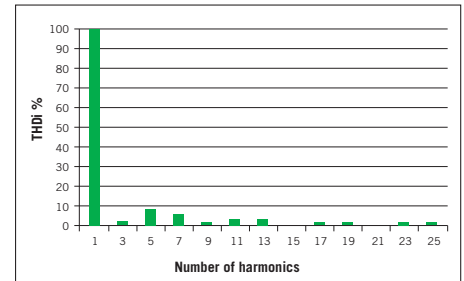

Typical measurement with FINHRM

### MECHANICAL DIMENSIONS mm

FINHRM	A	B	C	D	E	F	I	N	d	d2	Weight Kg.	Case
.016.M	300	250	400	440	29	9	396	100	16	M6x20	25	1
.030.M	300	250	400	440	29	9	396	100	16	M6x20	28.2	1
.050.M	300	290	560	600	29	9	585	120	16	M6x20	45.5	1
.075.M	300	290	560	600	29	9	585	120	16	M6x20	65	1
.100.M	320	440	660	700	29	9	706	195	16	M6x20	83	1
.150.M	320	440	660	700	29	9	706	195	16	M6x20	104	1
.200.M	450	504	860	900	29	9	920	225	16	M6x20	190	1
.215.M	450	504	860	900	29	9	920	225	16	M6x20	195	1

### CASE 1

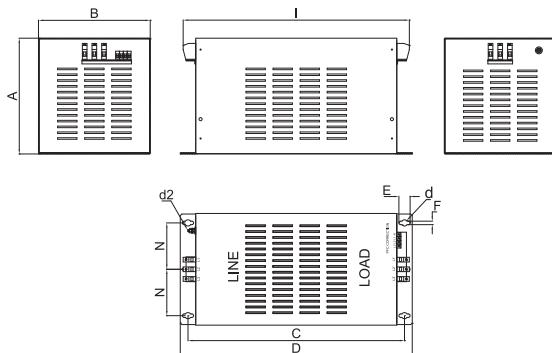

### ASSEMBLY CONNECTION "M"

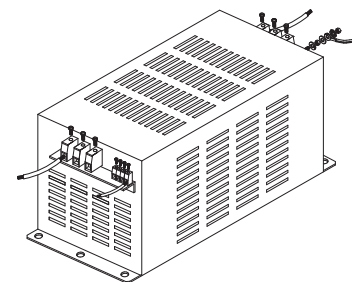



## Passive harmonic filter with excellent attenuation of current harmonic distortion and overvoltage spikes

Datasheet 3/2019

### APPROVALS:

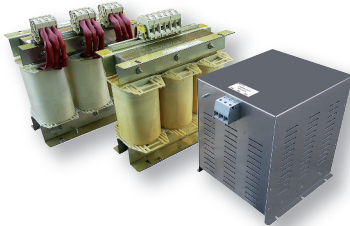

**FINHRM5. (010 - 160).M**

### FEATURES

- Rated current from 10 to 800A
- THDi reduction <5%
- Improves flicker and power factor

### BENEFITS

- Breakers available
- Finger safe protection available
- Enclosure available upon request

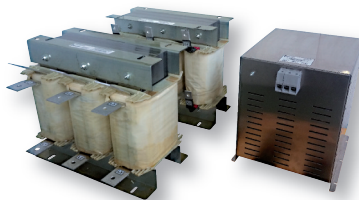

**FINHRM5.(210 - 800).B**

### MARKETS

- Variable frequency drives
- HVAC systems
- Industrial equipment
- Uninterruptible power supplies
- Pumps

### ORDERING CODE

FINHRM5	.007	.M	-60	.HV
Model	Current (A)	Connection	Frequency	690 Vac
		M = Terminal block	Only for 60Hz application	
		V= Screw		
		BC= Bus bar		

### ATTENUATION INDICATOR

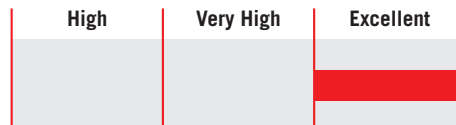

### ELECTRIC DIAGRAM

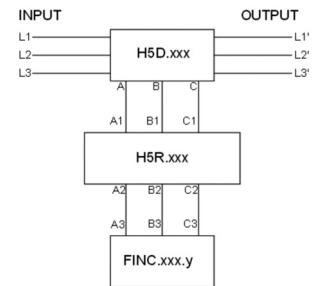

### TECHNICAL SPECIFICATIONS

<b>Nominal voltage</b>	230 / 400 / 480 / 690 Vac
<b>Frequency</b>	50 – 60 Hz
<b>Rated current</b>	10 to 800A
<b>Potential test voltage phase to phase</b>	2400 Vdc (2 sec.)
<b>Potential test voltage phase to ground</b>	3200 Vdc (2 sec.)
<b>IP Protection</b>	IP20 up to 160A IP00 over 210A
<b>Overload capability</b>	4 x Rated current (Switch ON) 2 x In 10 seconds 1.5 In for 10 minutes
<b>Climatic class</b>	-40 / +85° C
<b>MTBF at 40°C</b>	250.000 Hrs

ELECTRICAL CHARACTERISTICS						CONNECTIONS				
FINHRM5	Rated Current 50° C	Rated Power (KW)		Power Loss (W)		LINE			PE	
		400 Vac	480 Vac	400 Vac	480 Vac	Solid Cable (mm <sup>2</sup> )	Stranded Cable (mm <sup>2</sup> )	Terminal Torque (mm <sup>2</sup> )	d (mm)	Torque (Nm)
.010.M	10	4	5.5	55	80	0.2-10	0.2-6	1.2	M10	6
.016.M	16	7.5	11	105	160	0.2-10	0.2-6	1.2	M10	6
.032.M	32	15	18.5	210	275	0.2-10	0.2-6	1.2	M10	6
.045.M	45	22	30	273	370	0.5-10	0.5-10	1.8	M10	6
.080.M	80	40	48	398	475	0.5-10	0.5-10	1.8	M10	6
.120.M	120	60	72	492	672	6-35	4-25	4.5	M10	6
.160.M	160	80	96	590	710	10-50	10-50	4.0	M10	6

### TYPICAL MEASUREMENT

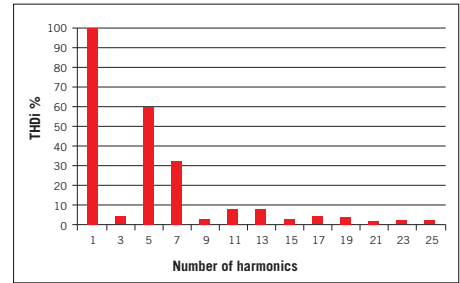

Typical measurement without FINHRM5

ELECTRICAL CHARACTERISTICS						CONNECTIONS			
FINHRM5	Rated Current 50° C	Rated Power (KW)		Power Loss (W)		LINE		PE	
		400 Vac	480 Vac	400 Vac	480 Vac	I (mm)	Torque (Nm)	(mm)	Torque (Nm)
.210.B	210	105	126	610	750	M12	20	M10	18
.260.B	260	130	160	780	940	M12	20	M10	18
.320.B	320	160	200	940	1150	M8	14	M10	18
.400.B	400	200	241	980	1200	M8	14	M10	18
.460.B	460	230	277	1280	1410	M8	14	M10	18
.600.B	600	280	360	1480	1750	M8	14	M10	18
.750.B	750	360	440	1690	1920	M8	14	M10	18
.800.B	800	380	460	1730	1970	M12	25	M10	18

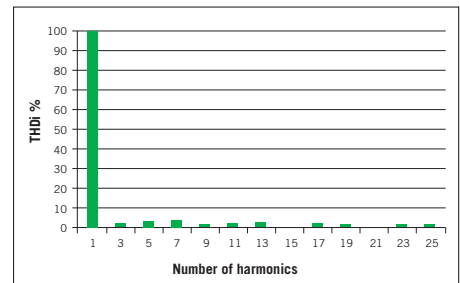

Typical measurement with FINHRM5

**MECHANICAL DIMENSIONS mm**

FINHRM5.010.M	A	B	C	D	E	F	G	H	Weight Kg.	Case
H5D.010.M	240	200	130	100	210	-	258	8	16.2	1
H5R.010.M	180	150	120	90	160	-	208	8	9.2	1
FINC.010.M *	260	100	135	120	210	104	5	-	2	1

FINHRM5.016.M	A	B	C	D	E	F	G	H	Weight Kg.	Case
H5D.016.M	240	200	130	95	210	-	275	8	28	2
H5R.016.M	180	150	120	90	156	-	205	8	16	2
FINC.016.M *	260	100	135	120	210	104	5	6	4	2

FINHRM5.032.M	A	B	C	D	E	F	G	H	Weight Kg.	Case
H5D.032.M	300	250	150	110	260	180	334	8	31	3
H5R.032.M	240	200	130	100	210	160	270	8	19	3
FINC.032.M *	300	120	135	120	320	104	5	-	6	3

FINHRM5.045.M	A	B	C	D	E	F	G	H	Weight Kg.	Case
H5D.045.M	300	250	150	110	260	180	334	8	44	4
H5R.045.M	240	200	130	100	210	160	270	8	31	4
FINC.045.M *	300	120	135	120	320	104	5	-	7	4

FINHRM5.080.M	A	B	C	D	E	F	G	H	Weight Kg.	Case
H5D.080.M	360	260	185	145	310	220	397	8	65	5
H5R.080.M	360	260	155	115	310	190	397	8	46	5
FINC.080.M *	350	130	135	120	380	104	5	-	8	5

FINHRM5.120.M	A	B	C	D	E	F	G	H	Weight Kg.	Case
H5D.120.M	480	360	230	185	410	320	505	10	120	6
H5R.120.M	360	260	185	145	310	270	410	8	68	6
FINC.120.M *	350	130	334	319	320	304	5	-	15	6

FINHRM5.160.M	A	B	C	D	E	F	G	H	Weight Kg.	Case
H5D.160.M	480	360	230	185	410	270	505	10	123	7
H5R.160.M	480	360	200	155	410	240	505	10	87	7
FINC.160.M *	350	130	234	219	380	204	5	-	16	7

\* 60Hz option available, FINC.xxx.M-60

**CASE 1, 2, 3, 4, 5, 6, 7**

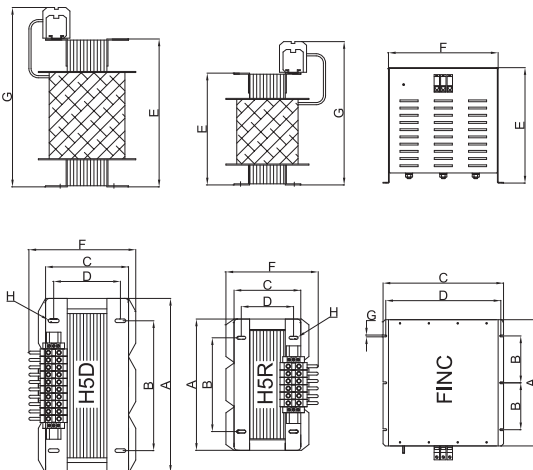

### MECHANICAL DIMENSIONS mm

FINHRM5.210.B	A	B	C	D	E	F	G	H	I	Weight Kg.	Case
H5D.210.B	480	360	260	215	420	310	50x5	10	12	154	8
H5R.210.B	480	360	230	185	420	280	30x7	10	12	119	8
FINC.210.M *	350	130	334	319	380	5	9	16	-	18	8

FINHRM5.260.B	A	B	C	D	E	F	G	H	I	Weight Kg.	Case
H5D.260.B	480	360	280	230	420	340	50x5	10	12	172	9
H5R.260.B	480	360	230	185	420	300	50x5	10	12	122	9
FINC.260.M *	670	630	300	254	382	29	9	16	-	30	9

FINHRM5.320.B	A	B	C	D	E	F	G	H	I	Weight Kg.	Case
H5D.320.B	600	380	230	185	520	330	50x5	10	15	195	10
H5R.320.B	480	360	240	195	420	280	50x5	10	15	130	10
FINC.320.M *	670	630	300	254	382	29	9	16	-	33	10

FINHRM5.400.B	A	B	C	D	E	F	G	H	I	Weight Kg.	Case
H5D.400.B	600	380	260	220	520	360	60x5	10	15	256	11
H5R.400.B	480	360	260	210	420	320	50x5	10	15	158	11
FINC.400.M *	670	630	300	254	382	29	9	16	-	35	11

\* 60Hz option available, FINC.xxx.M-60

### CASE 8, 9, 10, 11

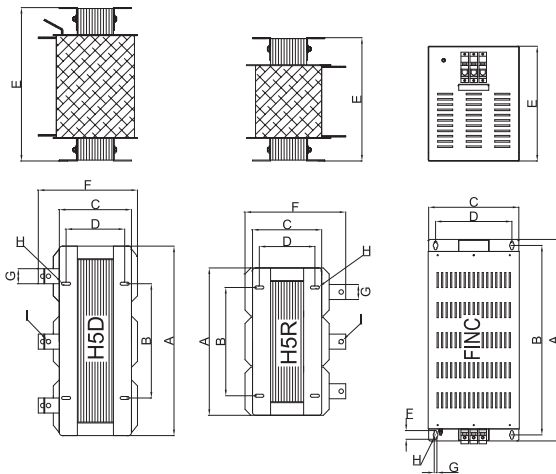

**MECHANICAL DIMENSIONS mm**

FINHRM5.480.B	A	B	C	D	E	F	G	H	I	J	Weight Kg.	Case
H5D.480.B	600	380	280	230	520	330	60x5	10	15	-	285	12
H5R.480.B	480	360	280	230	420	360	60x5	10	15	-	178	12
FINC.480.B*	800	760	300	254	382	29	9	16	9	25x10	40	12

FINHRM5.600.B	A	B	C	D	E	F	G	H	I	J	Weight Kg.	Case
H5D.600.B	660	540	275	230	610	320	60x5	10	15	-	315	13
H5R.600.B	620	380	255	210	510	300	60x5	10	15	-	240	13
FINC.600.B*	800	760	300	254	382	29	9	16	9	25x10	45	13

FINHRM5.750.B	A	B	C	D	E	F	G	H	I	J	Weight Kg.	Case
H5D.750.B	660	540	320	240	650	350	50x10	12	-	-	400	14
H5R.750.B	540	420	300	230	670	330	60x5	12	-	-	250	14
FINC.750.B*	750	710	585	540	382	29	9	16	11	30x15	47	14

FINHRM5.800.B	A	B	C	D	E	F	G	H	I	J	Weight Kg.	Case
H5D.800.B	660	540	320	240	700	420	50x10	10	12	-	410	15
H5R.800.B	660	420	300	230	480	360	60x5	10	12	-	260	15
FINC.800.B*	750	710	585	540	382	29	9	16	11	30x15	48	15

\* 60Hz option available, FINC.xxx.M-60

**CASE 12, 13, 14, 15**



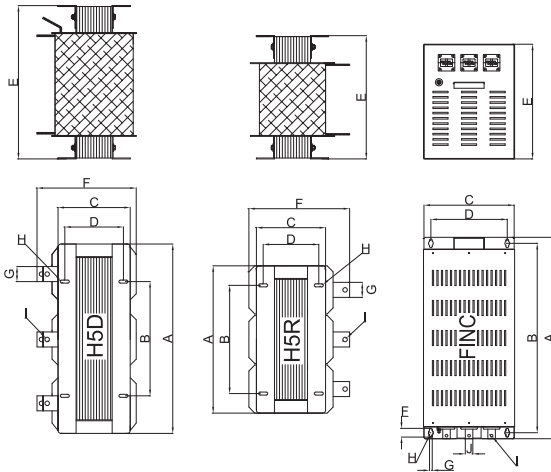



## Active harmonic filter with excellent attenuation of current harmonic distortion

Datasheet 3/2019

### APPROVALS:



FINHRMAD.(050 - 150)

### FEATURES

- Advanced digital control
- Rack unit or wall mounting installation options
- Modular system
- Remote control RS485 standard (Modbus-Profibus optional)

### BENEFITS

- Complete protection for overvoltage, under voltage, over current and over heating
- Unaffected by network conditions
- Touch screen LCD HMI
- Compensation for inductive and capacitive reactive power

### MARKETS

- Variable frequency drive
- Commercial building
- Oil and water plant
- Process automation
- End-user plant

### ORDERING CODE

FINHRMAD .090.		.5	.3F	.R
Model	Current (A)	4 = 400V	3F = 3phase	R = Rack mount
		5 = 480V	4F = 3phase with neutral	W = Wall mount

### ATTENUATION INDICATOR

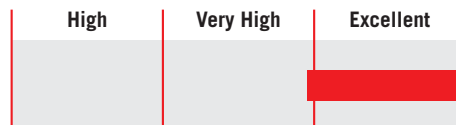

### TECHNICAL SPECIFICATIONS

Nominal voltage	400 / 480 Vac
Frequency	50 – 60 Hz -5 / +3%
Reactive power compensation	50 to 150A
Overall efficiency	>97%
Power grid structure	3-phase, 3-phase plus neutral
Current transformer	150:5 ~ 10,000:5
Harmonic filtering range	2 <sup>nd</sup> to 50th orders
Reaction time	<50 us
Overall response time	<5 ms
Switching frequency	20 KHz
Communication ports	RS485, Ethernet
Communication protocols	Modbus, TCP/IP
Module display interface	4.3 inch color LCD touch screen
Altitude	1500m Over power decreases by 1% every 100m
Operating temperature	-10°C / + 40°C
Protection class	IP 20
Noise level	<56 dB
Color	Ral 7035, Light gray

**ELECTRICAL CHARACTERISTICS**

FINHRMAD	Rated Current (A)	Rated Voltage (Vac)	Power Grid Structure	Cooling Mode	Response Time
.050.4.X.Y.Z	50	400 (-10%+10%)	3P3W ; 3P4W	Air 75L/sec	<5ms
.050.5.X.Y.Z	50	480 (-10%+10%)	3P3W	Air 75L/sec	<5ms
.100.4.X.Y.Z	100	400 (-10%+10%)	3P3W ; 3P4W	Air 75L/sec	<5ms
.100.5.X.Y.Z	100	480 (-10%+10%)	3P3W	Air 75L/sec	<5ms
.150.4.X.Y.Z	150	400 (-10%+10%)	3P3W ; 3P4W	Air 75L/sec	<5ms
.150.5.X.Y.Z	150	480 (-10%+10%)	3P3W	Air 75L/sec	<5ms

X = power grid structure Y = mounting type Z = HMI display

208Vac and 600Vac version available

**MECHANICAL DIMENSIONS mm**

FINHRMAD	A	B	C	D	Weight Kg.
.050.4.X.Y.Z	483	132	653	610	32
.050.5.X.Y.Z	483	132	653	610	32
.100.4.X.Y.Z	483	266	653	610	38
.100.5.X.Y.Z	483	266	653	610	38
.150.4.X.Y.Z	483	266	653	610	40
.150.5.X.Y.Z	483	266	653	610	40

Wall mounted available

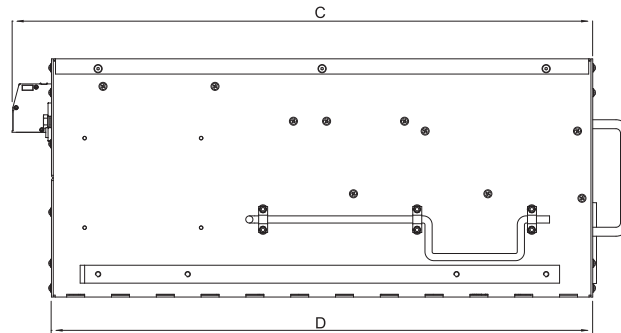
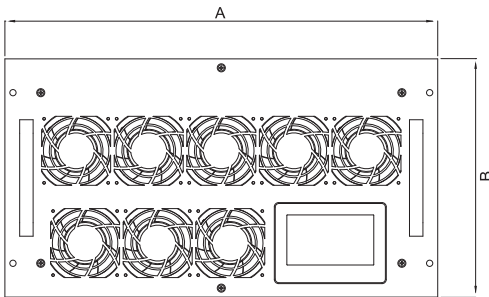
**RACK MOUNTED**



## Static var generator with excellent attenuation of inductive and reactive power

Datasheet 3/2019

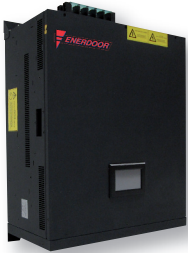
**APPROVALS:**

**FINSVG.(030 - 100)**
**FEATURES**

- No capacitor bank
- Controls PF compensation
- Unaffected by harmonic resonance
- High speed response

**BENEFITS**

- Compensation from 30 KVAR
- Compensation for inductive and capacitive reactive power
- Modular design
- Remote control RS485 as standard (Modbus-Profibus optional)

**MARKETS**

- Soft start motors
- DC motors
- Oil and water plants
- Processing machinery
- End-user facilities

**ORDERING CODE**

FINSVG	.100	.4	.4F	.W	.D
Model	Kvar	4 = 400V	3F = 3phase	R = Rack mount	D = with HMI
		5 = 480V	4F = 3phase with neutral	W = Wall mount	C = without HMI
		6 = 600V			
		7 = 690V			

**ATTENUATION INDICATOR**

High	Very High	Excellent

**TECHNICAL SPECIFICATIONS**

Nominal voltage	400 / 690 Vac
Frequency	50 – 60 Hz -5 / +3%
Reactive power compensation	30-100 Kvar
PF Compensation	0.99
Overall efficiency	>97%
Power grid structure	3-phase, 3-phase plus neutral
Current transformer	150:5 ~ 10,000:5
Reaction time	<50 us
Overall response time	<5 ms
Switching frequency	20 kHz
Communication ports	RS485
Communication protocols	Modbus, TCP/IP
Module display interface	4.3 inch LCD touch screen
Optional external display interface	8.0 inch LCD touch screen (FINHMI8.0)
Altitude	1500m Over power decreases by 1% every 100m
Operating temperature	-10°C / + 40°C
Protection class	IP 20
Noise level	<56 dB
Color	Ral 7035, Black

**ELECTRICAL CHARACTERISTICS**

FINSVG	Rated Compensation (Kvar)	Rated Voltage (Vac)	Power Grid Structure	Cooling Mode	Response Time
.030.4.X.Y.Z	30	400 (-40%+15%)	3P3W ; 3P4W	Air 75L/sec	<5ms
.040.5.X.Y.Z	40	480 (-20%+15%)	3P3W ; 3P4W	Air 359L/sec	<5ms
.050.4.X.Y.Z	50	400 (-40%+15%)	3P3W ; 3P4W	Air 75L/sec	<5ms
.063.5.X.Y.Z	63	480 (-20%+15%)	3P3W ; 3P4W	Air 359L/sec	<5ms
.050.6.X.Y.Z	50	600 (-30%+15%)	3P3W ; 3P4W	Air 359L/sec	<5ms
.075.5.X.Y.Z	75	480 (-20%+15%)	3P3W ; 3P4W	Air 359L/sec	<5ms
.075.6.X.Y.Z	75	600 (-30%+15%)	3P3W ; 3P4W	Air 359L/sec	<5ms
.090.6.X.Y.Z	90	600 (-30%+15%)	3P3W ; 3P4W	Air 359L/sec	<5ms
.100.4.X.Y.Z	100	400 (-40%+15%)	3P3W ; 3P4W	Air 300L/sec	<5ms

X = power grid structure Y = mounting type Z = HMI display

**MECHANICAL DIMENSIONS mm**

FINSVG	Rack mounted									Wall mounted							Weight Kg.
	A	B	C	F	G	I	L	N	T	H	J	E	P	Q	M	R	
.030.4.X.Y.Z	540	190	555	510	540	524	105	42.5	500	560	536	10	360	500	191	510	30
.040.5.X.Y.Z	544	250	655	590	640	526	140	55	520	665	638	10	400	505	253	590	35
.050.4.X.Y.Z	540	190	555	510	540	524	105	42.5	500	560	536	10	360	500	191	510	48
.063.5.X.Y.Z	544	250	655	590	640	526	140	55	520	665	638	10	400	505	253	590	48
.050.6.X.Y.Z	544	250	655	590	640	526	140	55	520	665	638	10	400	505	253	590	50
.075.5.X.Y.Z	544	250	655	590	640	526	140	55	520	665	638	10	400	505	253	590	55
.075.6.X.Y.Z	544	250	655	590	640	526	140	55	520	665	638	10	400	505	253	590	66
.090.6.X.Y.Z	544	250	655	590	640	526	140	55	520	665	638	10	400	505	253	590	67
.100.4.3F.Y.Z	540	269	550	470	520	521	180	44.5	500	557	530	10	400	505	286	478	67
.100.4.4F.Y.Z	540	269	550	470	520	521	180	44.5	500	553	518	10	400	505	271	520	67

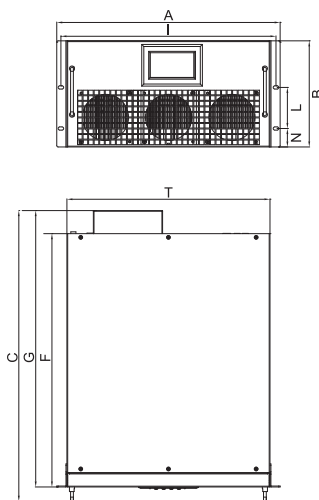
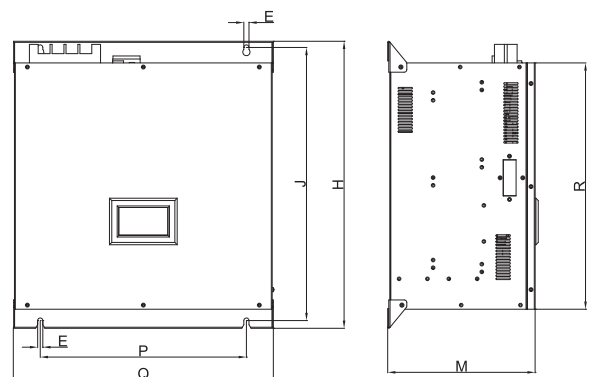
**RACK MOUNTED**

**WALL MOUNTED**

## Introduction

Motors controlled by VFDs or servo drives require additional attention to avoid overvoltage spikes, known as  $dV/dt$ . Voltage wave reflection is a function of the voltage rise time ( $dV/dt$ ) and the length of the motor cables. This phenomenon creates additional overvoltage spikes which cause premature degradation and failure to the motor insulation.

The challenge for OEMs, system integrators and distributors is to ensure that the installed motors are well protected from overvoltage. Markets using VFDs have adopted a special motor, better known as, a motor rated VFD or inverter duty motor.

The motor rated VFD construction can change significantly based on the manufacturer. However following the National Electrical Manufacturer's Association (NEMA), the greatest difference between a standard motor and an inverter duty motor is the winding insulation.

For example, a nominal 480 Vac AC drive using a standard grade motor should maintain performance and function with peak voltage up to 1000V. For inverter duty rated motors the acceptable peak voltage is typically 1500V.

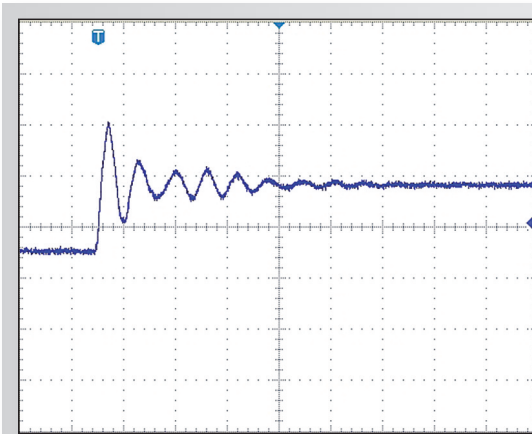

*Typical example of  $dV/dt$  measured on the motor with cable length of 50m (150 ft)*

## Theory

To better understand what causes motor failure and unforeseen challenges, it is best to first understand how a VFD is assembled. VFDs are made up of three major parts:

- The rectifier - takes incoming AC power and converts it to DC power
- The DC link - several capacitors used for energy storage from the output of the rectifier
- The inverter - produces 2-20 kHz signal used to generate the output waveform to the motor using pulse width modulation (PWM)

PWM is a technique which generates the width of a pulse based on modulation signal information. Due to this technique, the  $dV/dt$  presents a significant concern.

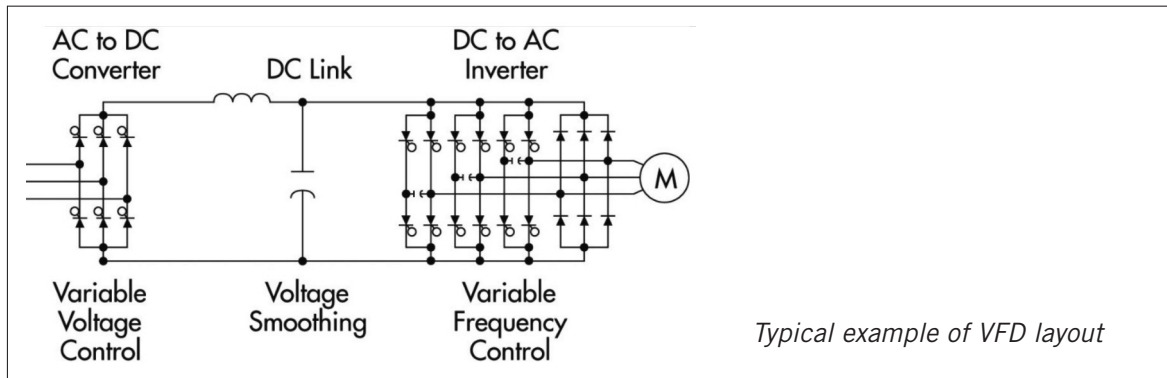

### The Solution

Enerdoor has developed the motor protection series to protect motors from harmful overvoltage and  $dV/dt$  spikes generated by the drive's output.

This is particularly useful for applications with variable frequency drives and servo drives. Enerdoor solutions include: common mode and differential mode chokes, sine wave filters and snubbers; all of which are designed to work with various carrier frequencies, output frequencies and applications.

### Specific Solutions

**Sine Wave Filters:** This series reduces the effect of the PWM by converting the drive's output to a true sine waveform, eliminating  $dV/dt$ .

The **FIN915SF** model is used with fundamental frequencies up to 25kHz.

The high frequency inductance **FIN960F** is a unique solution used for synchronous motor spindle applications with output frequencies ranging from 1 Hz to 10 kHz.

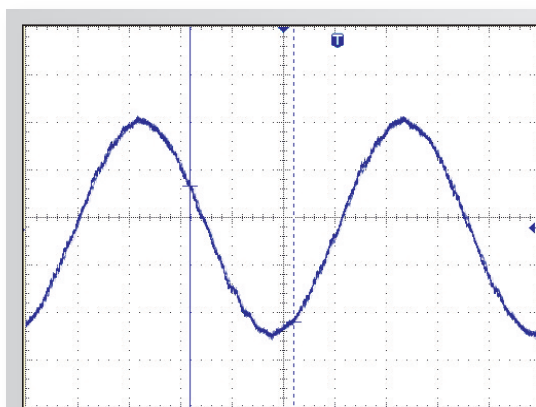

*Typical example of a waveform between the VFD and motor using an Enerdoor sine wave filter FIN915SFH*



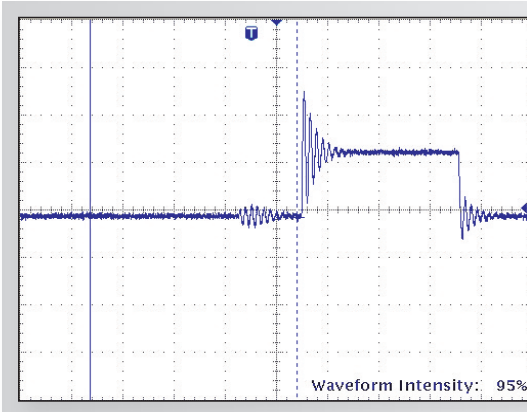

**Snubber:** Enerdoor snubber **FIN47SNB** is a unique solution to reduce common mode and differential mode noise. The snubber is used in parallel to the system and is an ideal solution for clients in need of improving the reliability of winding insulation and bearings.

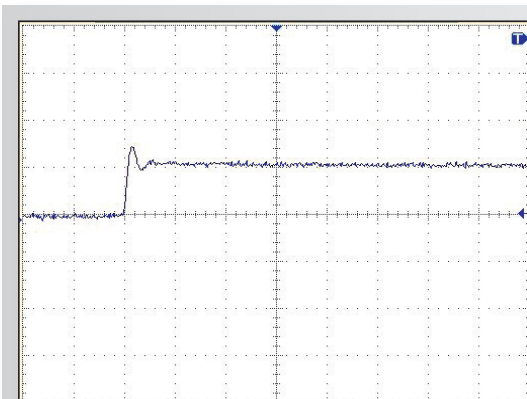

*Typical measurement of  $dV/dt$  on the motor side of VFD with cable length of 100m (300ft)*



*Typical measurement of  $dV/dt$  on the motor side of VFD with cable length of 100m (300ft) with Enerdoor snubber FIN47SNB installed*

Filter Selection Guide	Description	Current Range (A)	Voltage	CONNECTORS				FEATURES					APPLICATIONS				Approval	
				Cables	Terminal Blocks	Screws	Bus Bar	Common Mode Attenuation	Differential Mode Attenuation	Very Long Cable Applications	Output Frequency > 75Hz	Compact Case	Long Cable Application > 300m	CNC Machine	High Frequency Spindle Motor	Motor Controlled by VFD < 100m		Closed Loop Motor Application
<b>Motor Protection</b>																		
<b>FIN900</b>	3-phase	10-280	0-600	x	x	x		x				x		x		x		
<b>FIN930</b>	3-phase	6-200	0-600		x			x									x	
<b>FIN950U</b>	3-phase	8-300	0-600		x		x	x								x		
<b>FIN9555</b>	3-phase	3-20	0-600		x			x			x		x		x			
<b>FIN9558</b>	3-phase	12-110	0-600		x			x		x	x	x	x	x		x		
<b>FIN9580P</b>	3-phase	9-22	0-480	x	x								x					
<b>FIN9583</b>	3-phase	12-60	0-600		x						x	x				x		
<b>FIN960F</b>	3-phase	10-1000	0-750		x			x		x			x	x				
<b>FIN905SF</b>	3-phase	5-880	0-600		x		x	x	x		x							
<b>FIN915SFH</b>	3-phase	5-1100	0-600		x			x	x	x					x			
<b>FIN47SNB</b>	3-phase plus neutral	-	0-600		x					x		x	x			x	x	
<b>FINSTP</b>	star point to ground	-	0-600		x					x	x	x	x			x	x	



Enerdoor motor protection reduces harmful  $dV/dt$  generated by variable frequency drives imposed onto the motor. Motor protection devices are designed to work in various applications of switching frequencies and frequency outputs.

This series carries CE and UL approvals and offers a current range from 3 to 1100A. Enerdoor motor protection includes common mode and differential mode inductance, sine wave filters and snubbers.

Unique features include: high linearity vs frequency and current, very low operating temperatures, and compact dimensions.

The FIN960F high frequency inductance is a unique solution used for synchronous spindle motor applications. This line works with frequency output up to 2 kHz while allowing the motor to operate at a low temperature.

The FIN905SF and FIN915SFH sine wave filters reduce the PWM effect, convert the PWM to a sine wave and eliminate  $dV/dt$ . These lines work with applications in open or closed loop feedback.

The FIN905SF works with frequency output up to 70 Hz. The FIN915SFH line is used with fundamental frequencies up to 2 kHz while maintaining a very low application temperature.

### Motor protection applications include:

- Motors controlled by drives
- Pumps and conveyors
- Automated machinery
- Closed loop motor applications
- High speed motors
- CNC machinery
- Long cable applications  
2,500m (8,200 ft)
- Process plants
- Water treatment plants
- Packaging machinery

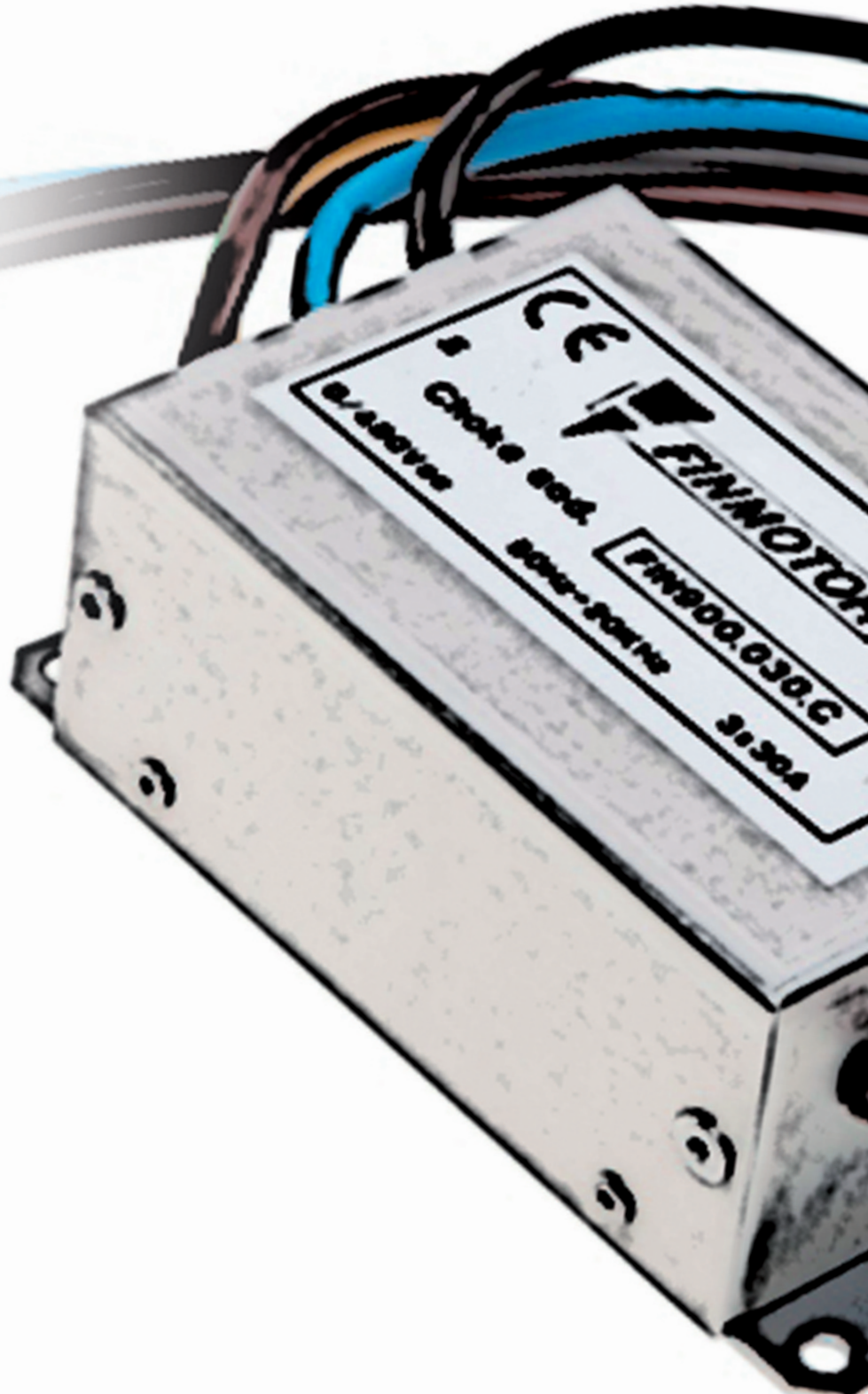



## Common mode choke with high attenuation for reducing dV/dt and high frequency

Datasheet 3/2019

**APPROVALS:**

**FIN900.(010 - 030).1C**
**FEATURES**

- 5 Year warranty
- Protects against voltage spikes on the motor
- Compact design

**BENEFITS**

- Rated current from 10 to 280A
- Reduces voltage rise and high frequency noise
- Helps pass emission tests for the IEC61000-6-4 Standards

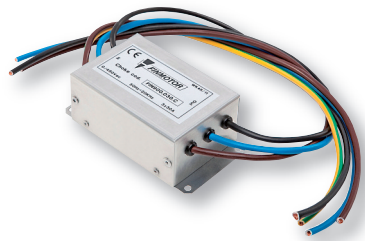
**FIN900.(010 - 030).C**
**MARKETS**

- Motors controlled by drives
- Automated machinery
- Conveyors
- Pumps

**ORDERING CODE**

FIN900	.016	.1C
Model	Current (A)	Connection
		1 C = cable 200mm
		2 C = cable 400mm
		C = cable
		V = screws

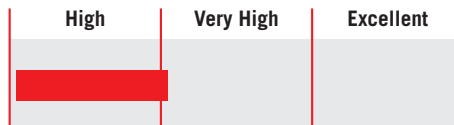
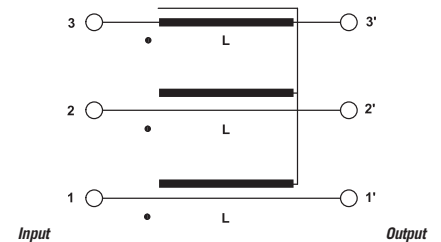
**FIN900.(010 - 280).V**
**ATTENUATION INDICATOR**

**ELECTRIC DIAGRAM**

**TECHNICAL SPECIFICATIONS**

Nominal voltage	0 / 600 Vac
Output frequency	50 - 3500 Hz
Rated current	10 to 280A
Carrier frequency (PWM)	0 - 16 kHz
Potential test voltage phase to phase	1750 Vdc (2 sec.)
Potential test voltage phase to ground	2150 Vdc (2 sec.)
IP Protection	IP20
Overload capability	4 x Rated current (Switch ON) 2 x In 10 seconds 1.5 In for 10 minutes
Climatic class	-40 / +85° C
MTBF at 40°C	250.000 Hrs

### ELECTRICAL CHARACTERISTICS

FIN900	Rated Current 40°C	Rated Current 50°C	Power Loss (W)
.010.1C	10	9	6
.016.1C	16	14	6
.030.1C	30	26	6

FIN900	Rated Current 40°C	Rated Current 50°C	Power Loss (W)
.010.C	10	9	6
.016.C	16	14	6
.030.C	30	26	6

FIN900	Rated Current 40°C	Rated Current 50°C	Power Loss (W)
.010.V	10	9	6
.016.V	16	14	10
.030.V	30	26	15
.050.V	50	45	23
.080.V	80	72	28
.100.V	100	90	45
.150.V	150	135	75
.200.V	200	180	83
.280.V	280	252	96

### CONNECTIONS

LINE		PE	
d (mm)	Torque (Nm)	d1 (mm)	Torque (Nm)
-	-	M12	20
-	-	M12	20
-	-	M12	20

LINE		PE	
d (mm)	Torque (Nm)	d1 (mm)	Torque (Nm)
-	-	-	-
-	-	-	-
-	-	-	-

LINE		PE	
d (mm)	Torque (Nm)	d1 (mm)	Torque (Nm)
M4	1.2	M4	1.2
M5	4	M4	1.2
M5	4	M4	1.2
M6	6	M5	4
M6	6	M5	4
M8	14	M8	14
M8	14	M8	14
M10	18	M10	18
M12	18	M10	18

### TYPICAL MEASUREMENT

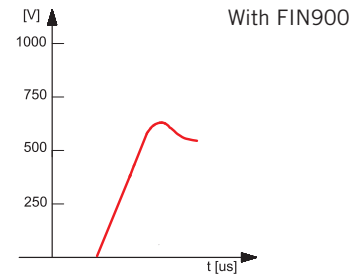
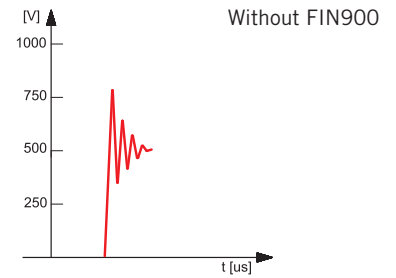

Example of measurement in a typical application using a servo drive

### MECHANICAL DIMENSIONS mm

FIN900	A	B	d	V	d1	H	Weight Kg.	Case
.010.1C	60	65	2	12	M12	200	0.5	1C
.016.1C	60	65	2	12	M12	200	0.5	1C
.030.1C	60	65	2	12	M12	200	0.55	1C

### CASE 1C

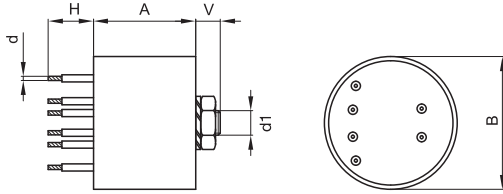

### ASSEMBLY CONNECTION "1C"

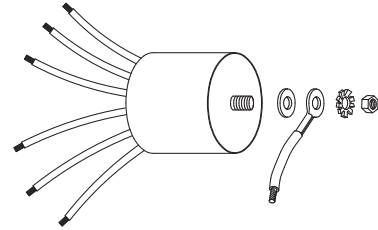

FIN900	A	B	d	V	F	H	I	L	N	Weight Kg.	Case
.010.C	42	65	2	200	4.2	120	96	110	51	0.7	C
.016.C	42	65	2	200	4.2	120	96	110	51	0.7	C
.030.C	42	65	2	200	4.2	120	96	110	51	0.75	C

### CASE C

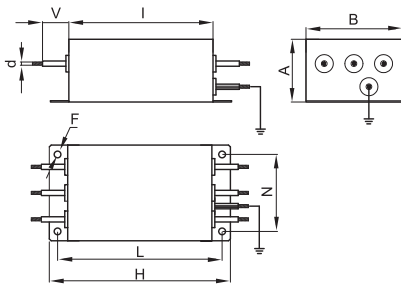

### ASSEMBLY CONNECTION "C"

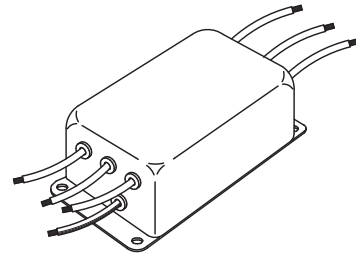

## MECHANICAL DIMENSIONS mm

FIN900	A	B	C	d	d1	V	F	H	I	L	N	P	S	Weight Kg.	Case
.010.V	58	86	44	M4	M4	14	4.5	186	160	176	30	40	38	2	1
.016.V	58	86	44	M5	M4	14	4.5	186	160	176	30	40	38	2	1
.030.V	58	86	44	M5	M4	14	4.5	186	160	176	30	40	38	2	1
.050.V	58	86	44	M6	M5	14	4.5	186	160	176	30	40	38	2	1
.080.V	90	100	46	M6	M5	28	4.5	246	220	235	35	70	64	3	2
.100.V	90	185	84	M8	M8	25	6.5	356	320	340	77.5	70	69	5	3
.150.V	90	220	120	M8	M8	29	6.5	356	320	340	95	70	60	7	4
.200.V	90	220	120	M10	M10	29	6.5	356	320	340	95	70	60	7.5	4
.280.V	90	220	120	M12	M10	29	6.5	356	320	340	95	70	60	8	4

### CASE 1, 2

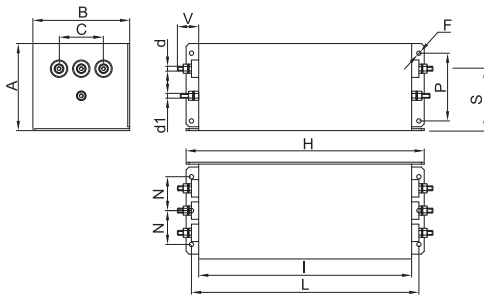

### ASSEMBLY CONNECTION "V"

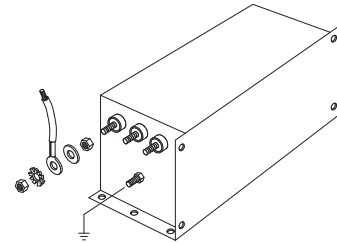

### CASE 3, 4

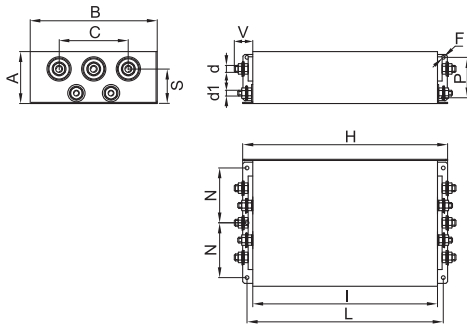

### ASSEMBLY CONNECTION "V"

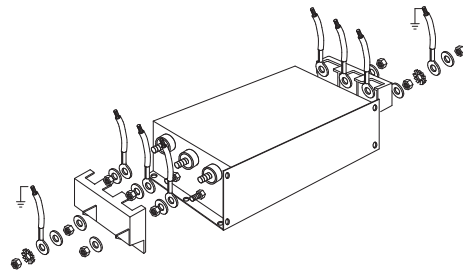



## Common mode choke with very high attenuation for reducing dV/dt

Datasheet 3/2019

**APPROVALS:**

**FIN930.(006 - 200).M**

**FEATURES**

- Rated current from 6 to 200A
- Increases motor life
- Protects against voltage spikes on the motor

**BENEFITS**

- 5 Year warranty
- Safety terminal block connectors
- Helps pass immunity and emission tests for the IEC61000-6-2 and IEC61000-6-4 Standards

**MARKETS**

- Motors controlled by drives
- Pumps
- Conveyors
- Spindle motors closed loop

**ORDERING CODE**

FIN930	.055	.M
Model	Current (A)	Connection
		M = Terminal block

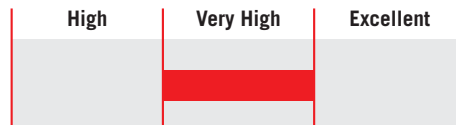
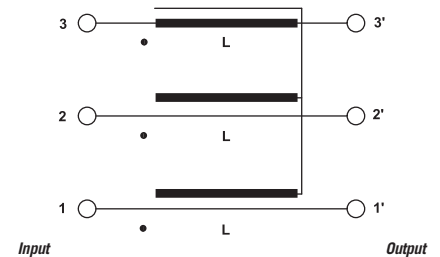
**ATTENUATION INDICATOR**

**ELECTRIC DIAGRAM**

**TECHNICAL SPECIFICATIONS**

<b>Nominal voltage</b>	0 / 600 Vac
<b>Output frequency</b>	50 - 3500 Hz
<b>Rated current</b>	6 to 200A
<b>Carrier frequency (PWM)</b>	0 - 16 kHz
<b>Potential test voltage phase to phase</b>	2400 Vdc (2 sec.)
<b>Potential test voltage phase to ground</b>	3200 Vdc (2 sec.)
<b>IP Protection</b>	IP20
<b>Overload capability</b>	4 x Rated current (Switch ON) 2 x In 10 seconds 1.5 In for 10 minutes
<b>Climatic class</b>	-40 / +85° C
<b>MTBF at 40°C</b>	250.000 Hrs

### ELECTRICAL CHARACTERISTICS

FIN930	Rated Current 40°C	Rated Current 50°C	Power Loss (W)
.006.M	8	6	3
.012.M	14	12	3
.016.M	18	16	4
.025.M	28	25	4
.032.M	35	32	5
.042.M	50	42	7
.055.M	63	55	8
.070.M	80	70	13
.080.M	90	80	13
.100.M	110	100	15
.115.M	130	115	22
.150.M	175	150	25
.200.M	230	200	28

### CONNECTIONS

LINE			PE	
Solid Cable (mm <sup>2</sup> )	Stranded Cable (mm <sup>2</sup> )	Terminal Torque (Nm)	d (mm)	Torque (Nm)
0.2 - 10	0.2 - 6	1.2	M6	1.2
0.2 - 10	0.2 - 6	1.2	M6	1.2
0.2 - 10	0.2 - 6	1.2	M6	1.2
0.2 - 10	0.2 - 6	1.2	M6	1.2
0.2 - 10	0.2 - 6	1.2	M6	1.2
0.5 - 16	0.5 - 10	1.8	M6	1.8
0.5 - 16	0.5 - 10	1.8	M6	1.8
4 - 25	6 - 35	4.5	M10	4.5
4 - 25	6 - 35	4.5	M10	4.5
10 - 50	10 - 50	4	M10	4
10 - 50	10 - 50	4	M10	4
35 - 95	35 - 95	20	M10	20
35 - 95	35 - 95	20	M10	20

### TYPICAL MEASUREMENT

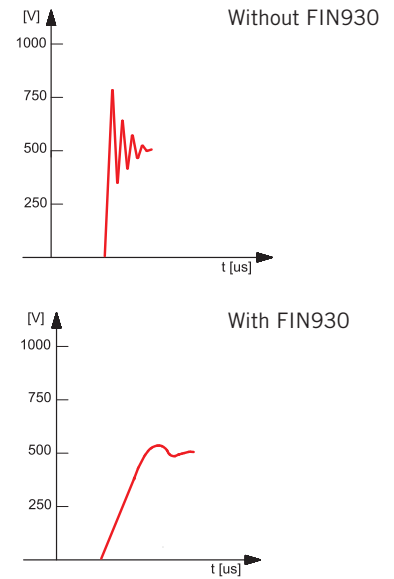

Example of measurement in a typical application using a servo drive

### MECHANICAL DIMENSIONS mm

FIN930	A	B	V	V1	F	H	I	L	N	d	Weight Kg.	Case
.006.M	140	50	19	15	6	226	200	7	28	M6	1.7	1
.012.M	140	50	19	15	6	226	200	7	28	M6	1.7	1
.016.M	177	60	19	15	6	267	237	8	34	M6	1.7	1
.025.M	177	60	19	15	6	267	237	8	34	M6	2.3	1
.032.M	177	60	19	15	6	267	237	8	34	M6	2.3	1
.042.M	177	70	19	25	6	295	265	8	44	M6	3.4	1
.055.M	177	70	19	33	6	295	265	8	44	M6	3.5	1
.070.M	205	80	28	38	8	390	340	12	53	M10	6	1
.080.M	205	80	28	38	8	390	340	12	53	M10	6	1
.100.M	205	80	28	43	8	390	340	12	53	M10	7.1	1
.115.M	205	80	28	43	8	390	340	12	53	M10	7.1	1
.150.M	220	105	28	50	8	420	370	12	78	M10	8.5	1
.200.M	220	105	28	50	8	420	370	12	78	M10	8.5	1

### CASE 1

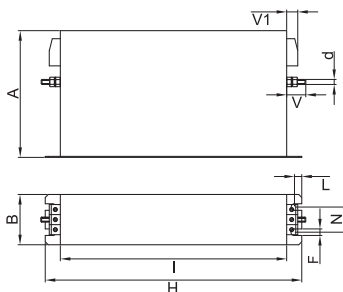

### ASSEMBLY CONNECTION "M"

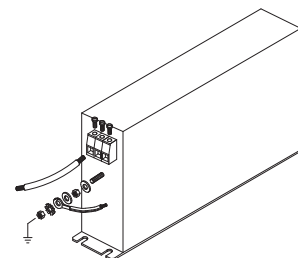



## Differential mode choke with very high attenuation to reduce dV/dt

Datasheet 3/2019



**FIN950U.(008 - 300).M**

Models available with current ratings up to 3000A

### APPROVALS:



### FEATURES

- Rated current from 8 to 300A
- Increases motor life
- Protects against voltage spikes on the motor

### BENEFITS

- Terminal blocks up to 200A
- Low power loss
- Available in open frame or enclosure

### MARKETS

- Motors controlled by drives
- Pumps
- Conveyors

### ORDERING CODE

FIN 950U .008 .M  
 Model Current (A) Connection  
 M = Terminal block

### ATTENUATION INDICATOR

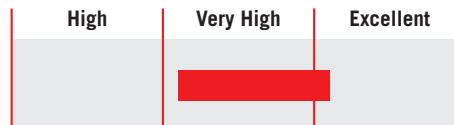

### ELECTRIC DIAGRAM

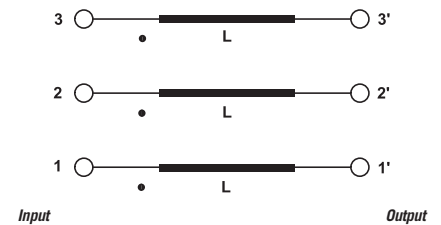

### TECHNICAL SPECIFICATIONS

Nominal voltage	0 / 600 Vac *
Output frequency	0 - 100 Hz
Carrier frequency	0 - 16 kHz
Rated current	8 to 300A
Insulation class	H
IP Protection	IP20 up to 200A IP00 over 200A
Saturation current	4 x Rated current (Switch ON) 2 x In 10 seconds 1.5 In for 10 minutes 1.5 x Nominal current
Climatic class	-40 / +85° C
MTBF at 40°C	250.000 Hrs

\* Available higher voltages



### ELECTRICAL CHARACTERISTICS

FIN950U	Rated Current 40°C	Rated Current 50°C	Power Loss (W)
.008.M20	8	6	23
.012.M12	12	10	30
.024.M070	24	21	36
.050.M038	50	45	61
.090.M019	90	81	73
.150.M013	150	135	120
.200.M0080	200	180	150
.300.M0053	300	260	225

### CONNECTIONS

LINE			PE
Solid Cable (mm <sup>2</sup> )	Stranded Cable (mm <sup>2</sup> )	Terminal Block Torque (Nm)	Torque (Nm)
0.2 - 10	0.2 - 6	1.2	1.2
0.2 - 10	0.2 - 6	1.2	1.2
0.2 - 10	0.2 - 6	1.2	1.2
0.5 - 10	0.5 - 10	1.8	1.8
10 - 50	10 - 50	4.0	4.0
10 - 50	10 - 50	4.0	4.0
35 - 95	35 - 95	20	20
70 - 240	70 - 240	30	30

### TYPICAL MEASUREMENT

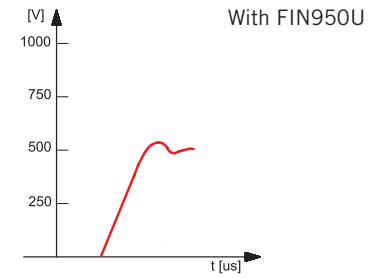
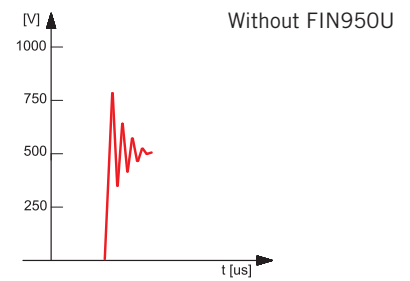

Example of measurement in a typical application using a servo drive

### MECHANICAL DIMENSIONS mm

FIN950U	A	B	C	D	F	H	Weight Kg.	Case
.008.M20	150	125	100	55	7	250	2	1
.012.M12	150	125	100	55	7	250	3	1
.024.M070	150	125	100	55	7	250	4	1
.050.M038	180	150	110	90	7	280	5	1
.090.M019	180	150	110	90	7	280	18	1
.150.M013	240	200	190	95	10	310	20	1
.200.M0080	240	200	190	95	10	310	26	1
.300.M0053	300	260	170	110	10	310	40	1

### CASE 1

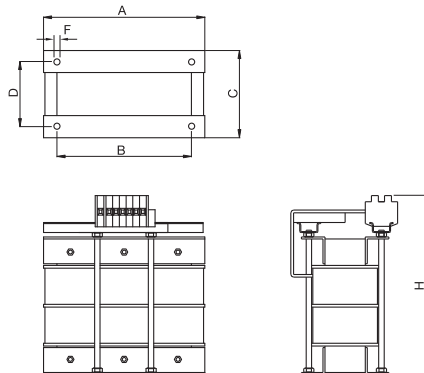



## High frequency differential choke with excellent attenuation to reduce dV/dt

Datasheet 3/2019

**FIN5955.(003 - 020).M**
**FEATURES**

- Rated current from 3 to 20A
- Increases motor life
- Protects against voltage spikes on the motor
- Low power loss up to 250 Hz frequency output

**MARKETS**

- High speed motors up to 250 Hz
- AC motors controlled by VFDs
- Woodworking machinery
- Spindle motors closed loop

**APPROVALS:**
**SCCR** by UL508A

**BENEFITS**

- 2 Year warranty
- Safety terminal block connectors
- Very compact design

**ORDERING CODE**

FIN5955	.020	.M
Model	Current (A)	Connection
		M = Terminal block

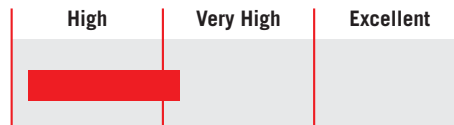
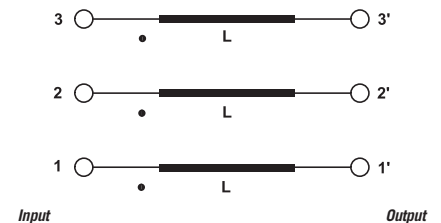
**ATTENUATION INDICATOR**

**ELECTRIC DIAGRAM**

**TECHNICAL SPECIFICATIONS**

Nominal voltage	0 / 600 Vac
Output frequency	0 - 250 Hz*
Rated current	3 to 20A
Carrier frequency (PWM)	0 - 16 kHz
Potential test voltage phase to phase	2400 Vdc (2 sec.)
Potential test voltage phase to ground	3200 Vdc (2 sec.)
IP Protection	IP20
Saturation current	4 x Rated current (Switch ON) 2 x In 10 seconds 1.5 In for 10 minutes 1.5 x Nominal current
Climatic class	-40 / +85° C
MTBF at 40°C	250.000 Hrs.

\* Optional output frequency 850 Hz

### ELECTRICAL CHARACTERISTICS

FIN5955	Rated Current 40°C	Rated Current 50°C	Power Loss (W)
.003.M	3	2	2.2
.006.M	6	5	2.4
.010.M	10	8	2.7
.020.M	20	17	3

### CONNECTIONS

LINE			PE	
Solid Cable (mm <sup>2</sup> )	Stranded Cable (mm <sup>2</sup> )	Terminal Torque (Nm)	V (mm)	Torque (Nm)
0.2 - 10	0.2 - 6	1.2	M4	1.2
0.2 - 10	0.2 - 6	1.2	M4	1.2
0.2 - 10	0.2 - 6	1.2	M4	1.2
0.2 - 10	0.2 - 6	1.2	M4	1.2

### TYPICAL MEASUREMENT

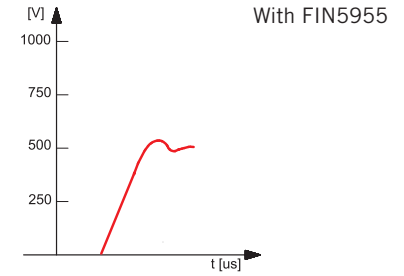
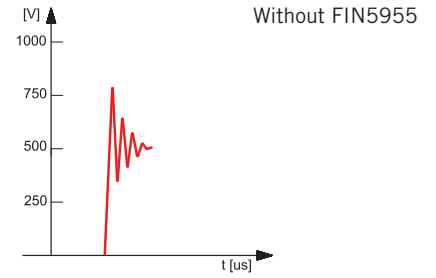

Example of measurement in a typical application using a servo drive

### MECHANICAL DIMENSIONS mm

FIN5955	A	B	C	D	H	N	I	V	Weight kg.	Case
.003.M	60	101	125	113	51	11	4x17	M4	0.40	1
.006.M	60	101	125	113	51	11	4x17	M4	0.40	1
.010.M	60	101	125	113	51	11	4x17	M4	0.45	1
.020.M	60	101	125	113	51	11	4x17	M4	0.45	1

### CASE 1

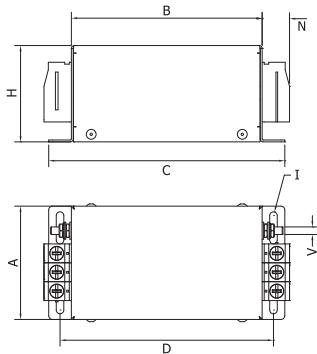

### ASSEMBLY CONNECTION "M"

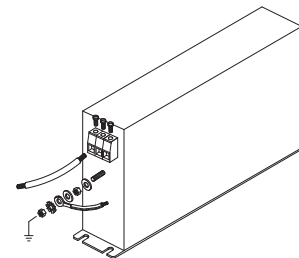



## High frequency differential choke with excellent attenuation to reduce dV/dt

Datasheet 3/2019

**APPROVALS:**

**FIN958.(012 - 110).M**
**FEATURES**

- Rated current from 12 to 110A
- Protects against voltage spikes on the motor
- Low power loss up to 1 kHz frequency output

**BENEFITS**

- 2 Year warranty
- Safety terminal block connectors

**MARKETS**

- High speed motors
- High speed pumps
- Woodworking machinery
- Spindle motors closed loop

**ORDERING CODE**

FIN958	.012	.M
Model	Current (A)	Connection
		M = Terminal block

**ATTENUATION INDICATOR**

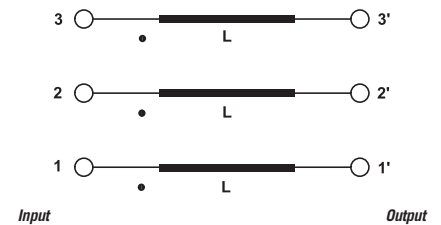
**ELECTRIC DIAGRAM**

**TECHNICAL SPECIFICATIONS**

Nominal voltage	0 / 600 Vac
Output frequency	0 - 1000 Hz
Rated current	12 to 110A
Carrier frequency (PWM)	0 - 16 kHz
Potential test voltage phase to phase	2400 Vdc (2 sec.)
Potential test voltage phase to ground	3200 Vdc (2 sec.)
IP Protection	IP20
Saturation current	4 x Rated current (Switch ON) 2 x In 10 seconds 1.5 In for 10 minutes 1.5 x Nominal current
Climatic class	-40 / +85° C
MTBF at 40°C	250.000 Hrs

### ELECTRICAL CHARACTERISTICS

FIN958	Rated Current 40°C	Rated Current 50°C	Power Loss (W)
.012.M	12	10	3.4
.020.M	20	18	4.4
.025.M	25	23	4.8
.032.M	32	28	5.3
.042.M	42	38	7
.060.M	60	54	11
.075.M	75	67	12
.090.M	90	81	12.7
.110.M	110	100	13

### CONNECTIONS

LINE			PE	
Solid Cable (mm <sup>2</sup> )	Stranded Cable (mm <sup>2</sup> )	Terminal Torque (Nm)	d (mm)	Torque (Nm)
0.2 - 10	0.2 - 6	1.2	M6	1.2
0.2 - 10	0.2 - 6	1.2	M6	1.2
0.2 - 10	0.2 - 6	1.2	M6	1.2
0.2 - 10	0.2 - 6	1.2	M6	1.2
0.2 - 10	0.2 - 6	1.2	M6	1.2
6 - 35	4 - 25	4.5	M6	6
6 - 35	4 - 25	4.5	M6	6
10 - 50	10 - 50	4.0	M10	6
35 - 95	35 - 95	20.0	M10	6

### TYPICAL MEASUREMENT

Without FIN958

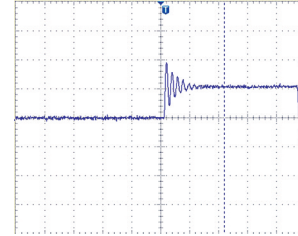

With FIN958

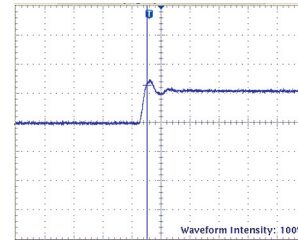

Example of measurement in a typical application using a servo drive

### MECHANICAL DIMENSIONS mm

FIN958	A	B	V	V1	F	H	I	L	N	d	Weight Kg.	Case
.012.M	100	90	22	16	5.4	250	220	7.5	60	M6	1.9	1
.020.M	100	90	22	16	5.4	250	220	7.5	60	M6	1.9	1
.025.M	100	90	22	16	5.4	250	220	7.5	60	M6	1.9	1
.032.M	100	90	22	16	5.4	250	220	7.5	60	M6	2.0	1
.042.M	100	90	22	35	5.4	250	220	7.5	60	M6	2.5	2
.060.M	135	85	22	39	6.5	270	240	7.5	60	M6	3.8	3
.075.M	135	85	22	39	6.5	270	240	7.5	60	M6	4.5	3
.090.M	155	90	24	43	6.5	270	240	7.5	65	M10	6.0	3
.110.M	170	125	26	51	6.5	380	350	7.5	102	M10	8.5	4

### CASE 1, 2, 3, 4

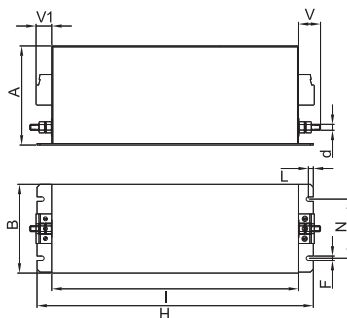

### ASSEMBLY CONNECTION "M"

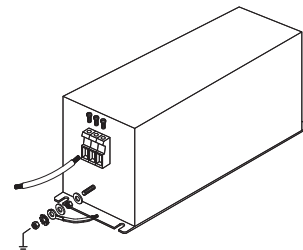



Datasheet 3/2019

## High frequency differential choke with excellent attenuation to reduce dV/dt

### APPROVALS:



UL508  
CSA C22.2

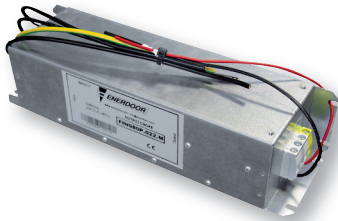

FIN5980P.(009 - 022).M

### FEATURES

- Rated current from 9 to 22A
- Increases motor life
- Protects against voltage spikes on the motor

### BENEFITS

- Overvoltage spikes regenerate into the DC bus
- Safety terminal block connectors
- Low power loss up to 1.5 kHz frequency output

### MARKETS

- Servo drives
- Spindle motors
- Closed loop motor applications

### ORDERING CODE

FIN 5980P .022 .M  
 Model Current (A) Connection  
 M = Terminal block

### ATTENUATION INDICATOR

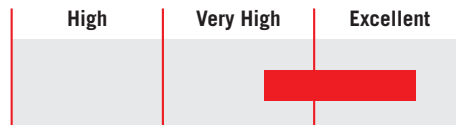

### ELECTRIC DIAGRAM

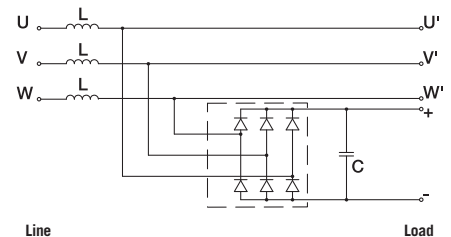

### TECHNICAL SPECIFICATIONS

Nominal voltage	0 / 480 Vac
Output frequency	0 – 1500 Hz
Rated current	9 to 22A
Carrier frequency (PWM)	0 - 16 kHz
Potential test voltage phase to phase	1200 Vdc (2 sec.)
Potential test voltage phase to ground	3200 Vdc (2 sec.)
IP Protection	IP20
Saturation current	4 x Rated current (Switch ON) 2 x In 10 seconds 1.5 In for 10 minutes 1.5 x Nominal current
Climatic class	-40 / +85° C
MTBF at 40°C	250.000 Hrs.

### ELECTRICAL CHARACTERISTICS

FIN5980P	Rated Current 40°C	Rated Current 50°C	Power Loss at 50 Hz (1000 Hz)
.009.M	12	10	1.2 (2.7)
.022.M	30	25	1.8 (4.7)

### CONNECTIONS

Solid Cable (mm <sup>2</sup> )	LINE		PE
	Stranded Cable (mm <sup>2</sup> )	Terminal Block Torque (Nm)	Torque (Nm)
0.5 - 16	0.5 - 10	1.8	1.8
0.5 - 16	0.5 - 10	1.8	1.8

### MECHANICAL DIMENSIONS mm

FIN5980P	A	B	C	D	E	F	H	I	L1	L2	N	Weight Kg.	Case
.009.M	60	295	345	330	220	280	60	5	300	300	11	2.2	1
.022.M	100	295	345	330	76	280	100	5	300	300	11	3	2

#### CASE 1

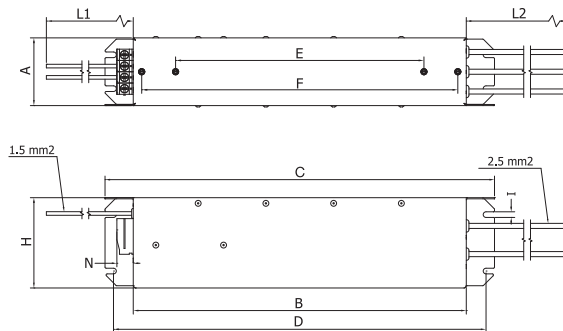

#### CASE 2

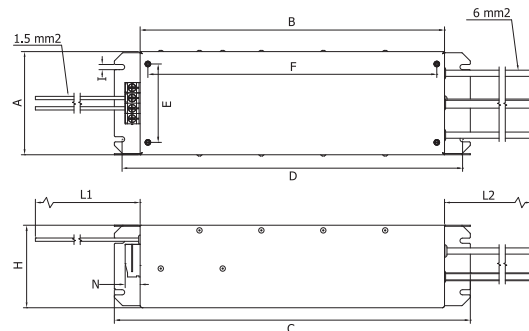



## High frequency differential choke with excellent attenuation to reduce dV/dt

Datasheet 3/2019

**APPROVALS:**

 UL508  
CSA C22.2

**FIN5983.(012 - 060).M**
**FEATURES**

- Rated current from 12 to 60A
- Increases motor life
- Protects against voltage spikes on the motor

**BENEFITS**

- Safety terminal block connectors
- Low power loss up to 1 kHz frequency output

**MARKETS**

- Motors controlled by drives
- Woodworking machinery
- Closed loop motor applications

**ORDERING CODE**

FIN 5983	.030	.M
Model	Current (A)	Connection
		M = Terminal block

**ATTENUATION INDICATOR**

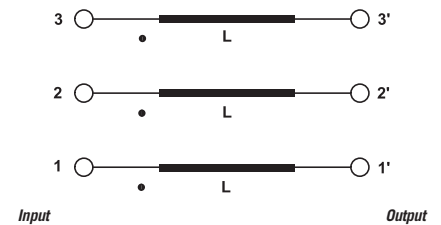
**ELECTRIC DIAGRAM**

**TECHNICAL SPECIFICATIONS**

Nominal voltage	0 / 600 Vac
Output frequency	0 – 1000 Hz
Rated current	12 to 60A
Carrier frequency (PWM)	0 - 16 kHz
Potential test voltage phase to phase	2400 Vdc (2 sec.)
Potential test voltage phase to ground	3200 Vdc (2 sec.)
IP Protection	IP20
Saturation current	4 x Rated current (Switch ON) 2 x In 10 seconds 1.5 In for 10 minutes 1.5 x Nominal current
Climatic class	-40 / +85° C
MTBF at 40°C	250.000 Hrs.



### ELECTRICAL CHARACTERISTICS

FIN5983	Rated Current 40°C	Rated Current 50°C	Power Loss (W)
.012.M	12	10	1.2 (2.7)
.030.M	30	25	1.8 (4.7)
.040.M	45	37	3 (7)
.060.M	60	50	8 (16.8)

### CONNECTIONS

Solid Cable (mm <sup>2</sup> )	LINE		Terminal Torque (Nm)	PE Torque (Nm)
	Stranded Cable (mm <sup>2</sup> )			
0.5 - 16	0.5 - 10		1.8	1.8
0.5 - 16	0.5 - 10		1.8	1.8
0.5 - 16	0.5 - 10		1.8	1.8
4 - 25	6 - 35		4.5	4.5

### TYPICAL MEASUREMENT

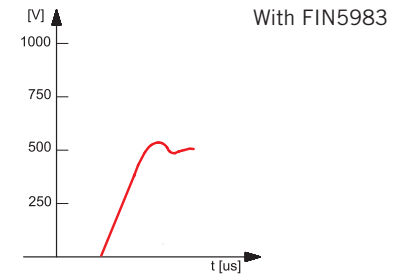
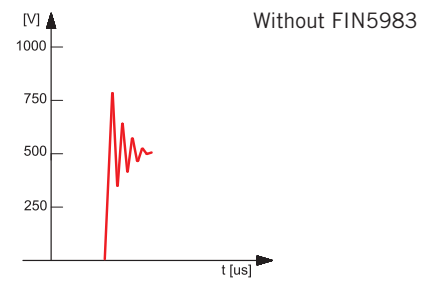

Example of measurement in a typical application using a servo drive

### MECHANICAL DIMENSIONS mm

FIN5983	A	B	C	D	E1	E2	F	G	H	J	L	I	N	Weight Kg.	Case
.012.M	140	295	345	330	14	76	280	80	80	50	300	5	33	2.2	1
.030.M	140	295	345	330	14	76	280	80	80	50	300	5	33	2.5	1
.040.M	200	295	345	330	-	160	280	120	80	50	300	5	38	3.2	1
.060.M	200	295	345	330	-	160	280	120	80	50	300	5	38	4	1

### CASE 1

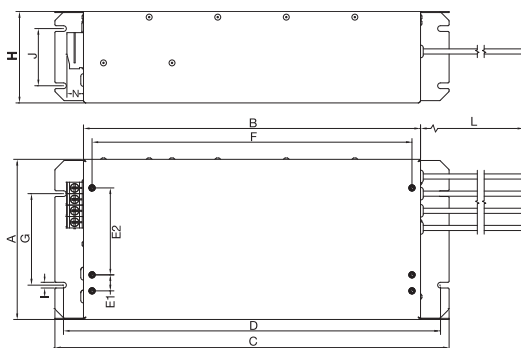

### ASSEMBLY CONNECTION "M"

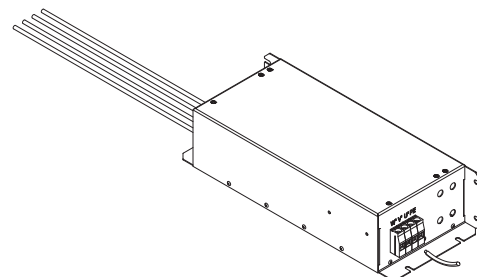



## High frequency differential mode choke with excellent attenuation for high speed motors

Datasheet 3/2019

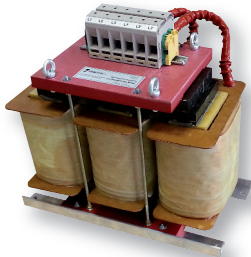
**APPROVALS:**

**FIN960F.(010 - 1000).M**
**FEATURES**

- Rated current from 10 to 1000A
- Increases motor life
- Protects against voltage spikes on the motor
- Customizable per motor specifics to optimize the system

**MARKETS**

- High speed motors
- CNC machinery
- Woodworking machinery

**BENEFITS**

- Low power loss with frequency output up to 30 kHz
- No ventilation required
- Excellent performance versus frequency and current
- Available in open frame or enclosure

**ORDERING CODE**

FIN960F	.050	.M	010
Model	Current (A)	Connection	Inductance value (L)

M = Terminal block

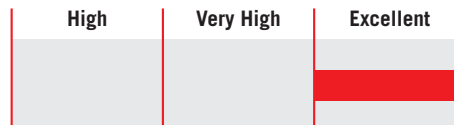
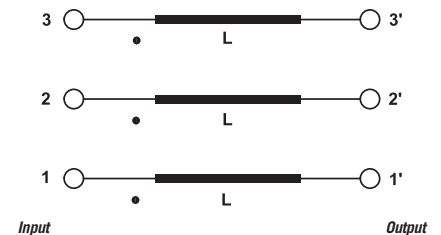
**ATTENUATION INDICATOR**

**ELECTRIC DIAGRAM**

**TECHNICAL SPECIFICATIONS**

Nominal voltage	0 / 750 Vac
Output frequency	0 - 30 kHz
Rated current	10 to 1000A
Carrier frequency (PWM)	0 - 60 kHz
Potential test voltage phase to phase	2400 Vdc (2 sec.)
Potential test voltage phase to ground	3200 Vdc (2 sec.)
IP Protection	IP20
Saturation current	4 x Rated current (Switch ON) 2 x In 10 seconds 1.5 In for 10 minutes 1.5 x Nominal current
Climatic class	-40 / +85° C
MTBF at 40°C	250.000 Hrs

### ELECTRICAL CHARACTERISTICS

FIN960F	Rated Current (S1)	Peak Current (S6)	Power Loss (W)
.050.M010	50	75	70
.110.M010	110	150	110
.160.M010	160	200	150
.095.M020	95	130	90
.130.M025	130	160	115
.160.M025	160	180	170
.090.M030	90	120	60
.050.M040	50	75	80
.110.M040	110	150	280
.200.M040	200	240	580
.085.M060	85	120	280
.135.M060	135	165	300
.170.M060	170	205	520
.120.M100	120	145	305
.200.M100	200	240	820

### CONNECTIONS

Solid Cable (mm <sup>2</sup> )	LINE		Terminal Block Torque (Nm)	PE Torque (Nm)
	Stranded Cable (mm <sup>2</sup> )			
2.5 - 50	2.5 - 35	5	5	
10 - 70	10 - 50	6	6	
10 - 95	10 - 50	10	10	
10 - 70	10 - 50	6	6	
10 - 95	10 - 70	10	10	
10 - 95	10 - 70	10	10	
10 - 70	10 - 50	6	6	
2.5 - 50	2.5 - 35	5	5	
10 - 70	10 - 50	6	6	
16 - 150	16 - 95	20	20	
10 - 70	10 - 50	6	6	
10 - 95	10 - 70	10	10	
10 - 95	10 - 70	10	10	
10 - 70	10 - 50	6	6	
16 - 250	16 - 95	20	20	

Custom nominal current and inductance value combinations are available to accommodate specific motor characteristics and working cycles.

S1 (100%) at 40C° - S6 (40% 2 min) at 40C°

### MECHANICAL DIMENSIONS mm

FIN960F	A	B	C	D	E	F	G	Weight Kg.	Case
.050.M010	230	250	80	100	7	270	120	6	1
.110.M010	240	260	110	140	7	270	150	18	2
.160.M010	370	400	170	230	12	350	250	37	3
.095.M020	240	260	110	140	7	270	150	20	2
.160.M025	500	540	200	260	12	500	300	75	5
.130.M030	500	540	200	260	12	500	300	65	5
.050.M040	280	300	140	160	8	280	180	19	6
.110.M040	500	540	200	260	12	500	300	65	5
.200.M040	500	540	200	260	12	500	300	120	5
.085.M060	500	540	200	260	12	500	300	65	5
.135.M060	500	540	200	260	12	500	300	88	5
.170.M060	500	540	200	260	12	500	300	105	5
.120.M100	500	540	200	260	12	500	300	95	5
.200.M100	660	700	320	390	12	600	410	200	7

### CASE 1, 2, 6

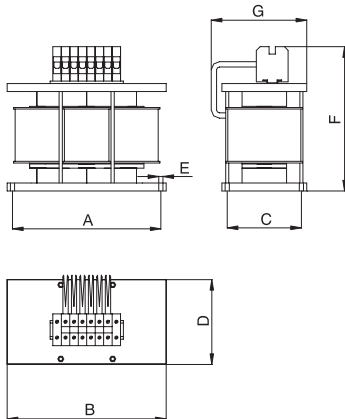

### CASE 3, 4, 5, 7

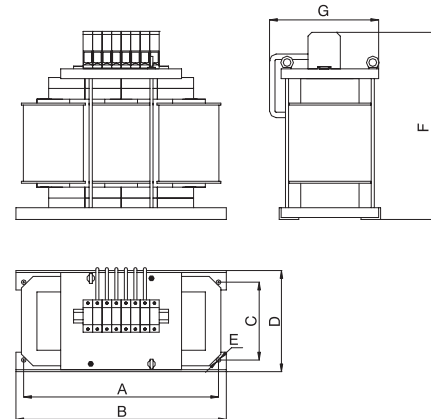



## Sine wave filter with excellent attenuation for variable frequency drive applications

Datasheet 3/2019

**APPROVALS:**

**FIN905SF.(005 - 045).M**
**FEATURES**

- Rated current from 5 to 880A
- Very compact design
- Available in Nema 1 or Nema 3R enclosures

**BENEFITS**

- Low power loss
- No ventilation required
- Excellent performance versus frequency and current
- Available in open frame or enclosure

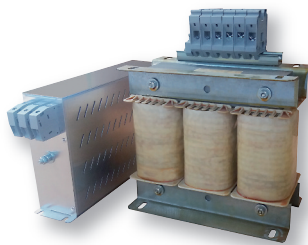
**FIN905SF.(060 - 180).M**
**MARKETS**

- Long cable applications - 2.500m
- Process plants
- Water treatment plants
- Variable frequency drives
- Agriculture

**ORDERING CODE**

FIN905SF	.100	.M	-N1
Model	Current (A)	Connection	Enclosure
		M = Terminal	N1 = Nema 1 (IP20)
		V = Screws	N3R = Nema 3R (IP54)
		B = Bus bar	

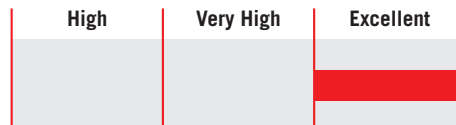
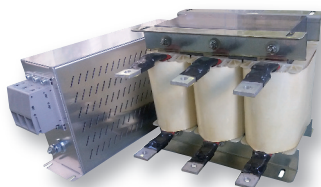
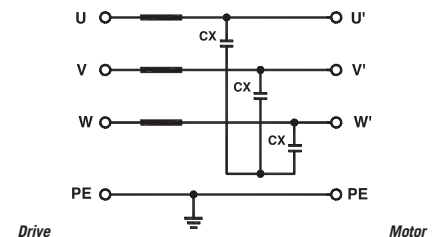
**ATTENUATION INDICATOR**

**ELECTRIC DIAGRAM**

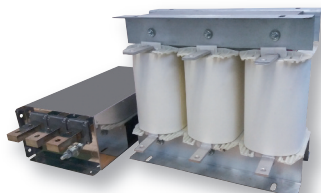
**FIN905SF.(260 - 410).B**
**TECHNICAL SPECIFICATIONS**

Nominal voltage	0 / 600 Vac
Output frequency	0 - 100 Hz
Rated current	5 to 880A
Carrier frequency (PWM)	>4 kHz, see table
Ambient temperature	70°C
Altitude	1000 m
Relative humidity	<95% no condensation
Saturation current	4 x Rated Current (Switch ON) 2 x In 10 seconds 1.5 x In 10 minutes 1.5 x Nominal current
IP Protection	IP20 up to 180A IP00 over 260A
Optional	Enclosure, fan

**FIN905SF.(480 - 880).B**

### ELECTRICAL CHARACTERISTICS

FIN905SF	Rated Current 40°C	Rated Current 50°C	Min. Switch Freq. (kHz)	Power Loss (W)
.005.M	5	4	4	67
.008.M	8	7	4	79
.010.M	10	8	4	88
.016.M	16	14	4	116
.025.M	25	21	4	151
.036.M	36	30	4	175
.048.M	48	39	4	250
.060.M	60	50	4	282
.075.M	75	60	4	340
.115.M	115	95	4	575

### CONNECTIONS

LINE			PE
Solid Cable (mm <sup>2</sup> )	Stranded Cable (mm <sup>2</sup> )	Terminal Block Torque (Nm)	Torque (Nm)
0.2-10	0.2-6	1.2	1.2
0.2-10	0.2-6	1.2	1.2
0.2-10	0.2-6	1.2	1.2
0.2-10	0.2-6	1.2	1.2
0.2-10	0.2-6	1.8	1.8
0.2-10	0.2-6	1.8	1.8
6-35	4-25	4.5	4.5
6-35	4-25	4.5	4.5
10-50	10-50	4	4

### TYPICAL MEASUREMENT

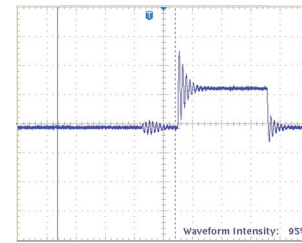

Standard waveform measured when the motor is controlled by VFD drive.

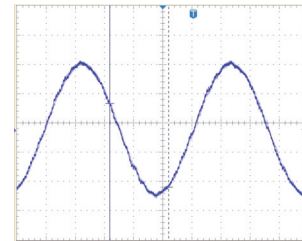

Standard waveform measured when Enerdoor sine wave filter is installed on motor controlled by VFD drive.

FIN905SF	Rated Current 40°C	Rated Current 50°C	Min. Switch Freq. (kHz)	Power Loss (W)
.180.B	180	145	4	695
.320.B	320	290	4	950
.410.B	410	350	6	1170
.480.B	480	420	6	1390
.660.B	660	580	6	2050
.750.B	750	650	6	2900
.880.B	880	750	6	3450

LINE			PE
Solid Cable (mm <sup>2</sup> )	Stranded Cable (mm <sup>2</sup> )	Terminal Block Torque (Nm)	Torque (Nm)
39-95	35-95	20.0	20.0
M8	14	M10	18
M8	14	M10	18
M12	20	M10	18
M12	20	M10	18
M12	20	M10	18
M12	20	M10	18

**MECHANICAL DIMENSIONS mm**

FIN905SF	A	B	C	D	E	F	G	H Ø	Weight Kg.	Case
005.M	180	90	156	150	60	116	235	8	8	1
008.M	180	90	156	150	60	116	235	8	10	1
010.M	180	90	156	150	60	116	235	8	11	1
016.M	240	130	210	210	95	165	290	8	16	1
025.M	240	130	210	210	95	165	290	8	20	1
036.M	240	130	210	210	95	165	290	8	22	2
.048.M	240	130	210	210	95	165	290	8	28	2

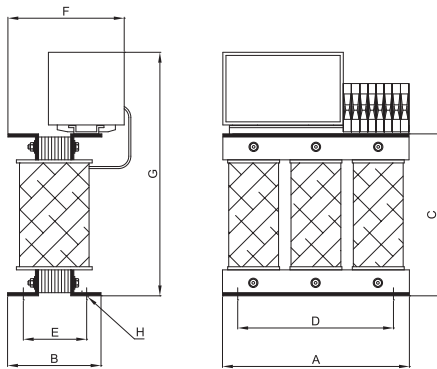
**CASE 1, 2**

FIN905SF	A	B	C	D	E	F	G	H	I	L	N	P	V	d	Weight Kg.	Case
.060.M	300	165	260	260	110	8	5	332	260	100	120	135	180	M5	34	3
.075.M	360	174	305	260	120	8	5	377	293	100	120	135	180	M5	47	3
.115.M	360	203	310	260	145	8	5	400	389	130	205	220	260	M5	72	4

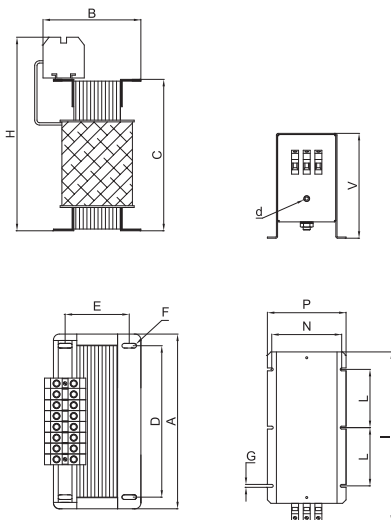
**CASE 3, 4**

## MECHANICAL DIMENSIONS mm

FIN905SF	A	B	C	D	E	F	G	H	I	L	N	P	V	d	S	Weight Kg.	Case
.180.B	350	230	310	260	165	8	5	400	389	130	205	220	260	M5	-	86	5
.260.B	480	280	410	360	230	8	30	5	400	130	290	305	260	M5	-	132	5
.320.B	48	300	410	360	230	8	40	5	400	130	290	305	260	M5	-	163	5
.410.B	480	340	410	360	230	10	60	5	400	130	290	305	260	M5	-	188	5
.480.B	480	360	410	360	230	10	60	5	660	620	245	292	260	M5	25x10	208	6
.660.B	600	370	510	380	240	10	60	5	660	620	245	292	260	M5	25x10	309	6
.750.B	600	390	510	380	240	10	80	5	830	750	245	292	260	M5	25x10	356	6
.880.B	600	370	570	380	240	10	80	5	830	750	245	292	260	M5	25x10	351	6

### CASE 5

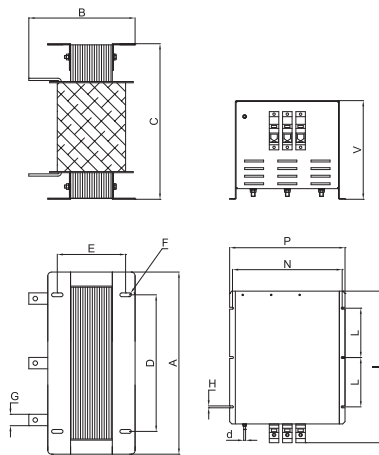

### CASE 6

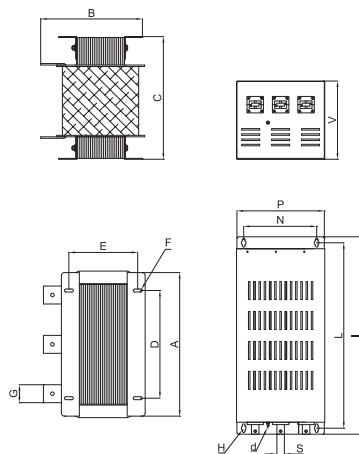



## High frequency sine wave filter with excellent attenuation for variable frequency drive applications

Datasheet 3/2019

### APPROVALS:

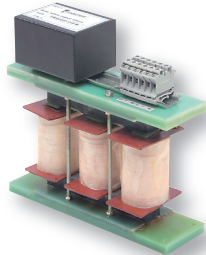

**FIN915SFH.(005 - 048).M**

### FEATURES

- Rated current from 5 to 1100A
- High performance sine wave output
- Eliminates dV/dt and increases motor life
- Ideal for high speed motor - 0 Hz to 10 kHz

### BENEFITS

- Terminal blocks up to 880A
- Very compact design
- Available in open frame or enclosure

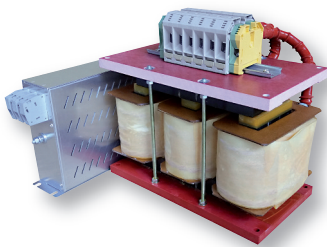

**FIN915SFH.(060 - 360).M**

### MARKETS

- Long cable applications - 2,500m
- Frequency drives and servo drives >75 Hz
- Process plants
- Water treatment plants
- Agriculture

### ORDERING CODE

FIN915SF	.100	.M	-N1
Model	Current (A)	Connection	Enclosure
		M = Terminal	N1 = Nema 1
		V = Screws	N3R = Nema 3R
		BC = Bus bar	

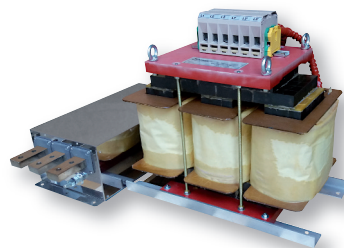

**FIN915SFH.(480 - 1100).M**

### ATTENUATION INDICATOR

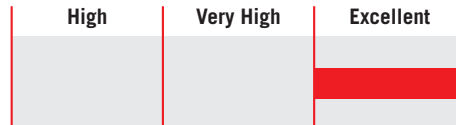

### ELECTRIC DIAGRAM

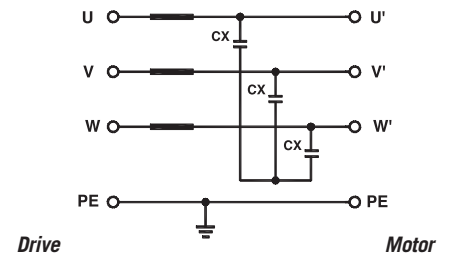

### TECHNICAL SPECIFICATIONS

Nominal voltage	0 / 600 Vac
Output frequency	0 Hz - 10 kHz
Rated current	5 to 1100A
Carrier frequency (PWM)	>2 kHz, see table
Ambient temperature	70°C
Altitude	1000 m
Relative humidity	<95% no condensation
Saturation current	4 x Rated Current (Switch ON) 2 x In 10 seconds 1.5 x In 10 minutes 1.5 x Nominal current
IP Protection	IP20 up to 360A IP00 over 480A
Optional	Enclosure, fan, finger safe protection



### ELECTRICAL CHARACTERISTICS

FIN915SFH	Rated Current 40°C	Min Switch Freq. (kHz)	Power Loss (W)
.005.M	5	2	50
.010.M	10	2	70
.016.M	16	2	98
.025.M	25	2	105
.036.M	36	2	110
.048.M	48	2	195
.060.M	60	2	220
.075.M	75	2	255
.115.M	115	4	420
.180.M	180	4	602
.210.M	210	4	650
.260.M	260	4	701
.360.M	360	6	800
.480.M	480	6	980
.610.M	610	6	1300
.680.M	680	6	1400
.770.M	770	6	2050
.860.M	860	6	2430
.960.M	960	6	2765
.1100.M	1100	6	2915

### CONNECTIONS

LINE			PE
Solid Cable (mm <sup>2</sup> )	Stranded Cable (mm <sup>2</sup> )	Terminal Block Torque (Nm)	Torque (Nm)
0.2-10	0.2-6	1.2	1.2
0.2-10	0.2-6	1.2	1.2
0.2-10	0.2-6	1.2	1.2
0.2-10	0.2-6	1.2	1.2
0.2-10	0.2-6	1.8	1.8
0.2-10	0.2-6	1.8	1.8
6-35	4-25	4.5	4.5
6-35	4-25	4.5	4
10-50	10-50	4	4
39-95	35-95	20	20
35-150	35-150	20	20
35-150	35-150	20	20
35-150	35-150	20	20
35-150	35-150	20	20
35-150	35-150	20	20
35-150	35-150	20	20
35-150	35-150	20	20
35-150	35-150	20	20
35-150	35-150	20	20
35-150	35-150	20	20
35-150	35-150	20	20
35-150	35-150	20	20

### TYPICAL MEASUREMENT

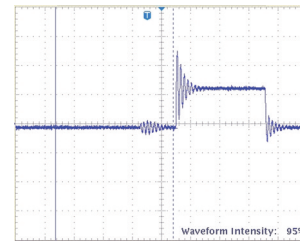

Standard waveform measured when the motor is controlled by VFD drive.

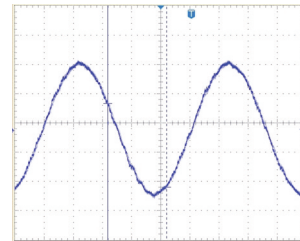

Standard waveform measured when Enerdoor sine wave filter is installed on motor controlled by VFD drive.

### MECHANICAL DIMENSIONS mm

FIN915SFH	A	B	C	D	E	F	G	Weight Kg.	Case
.005.M	260	170	252	240	110	8	138	5	1
.010.M	260	170	252	240	110	8	138	6.5	1
.016.M	260	170	252	240	110	8	138	8	1
.025.M	300	240	265	280	140	8	160	12	2
.036.M	300	240	265	280	140	8	160	14	2
.048.M	300	240	265	280	140	8	160	17	2

### CASE 1, 2

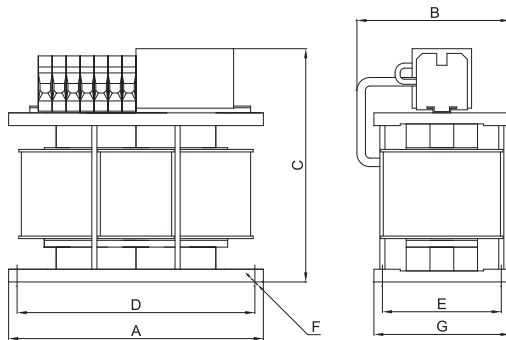

FIN915SFH	A	B	C	D	E	F	G	I	L	N	P	R	dØ	V	Weight Kg.	Case
.060.M	400	250	335	370	170	12	260	293	100	120	135	5	5	180	30	3
.075.M	540	360	460	500	200	12	260	293	100	120	135	5	5	180	38	3
.115.M	540	360	460	500	200	12	260	389	130	205	220	5	5	260	63	4
.140.M	540	360	460	500	200	12	260	389	130	205	220	5	5	260	80	4
.180.M	540	320	465	500	200	12	260	389	130	205	220	5	5	260	83	4
.210.M	540	320	465	500	200	12	260	450	150	280	295	5	5	260	88	5
.260.M	540	320	465	500	200	12	260	450	150	280	295	5	5	260	110	5
.360.M	540	320	465	500	200	12	260	450	150	280	295	5	5	260	150	5

### CASE 3, 4, 5

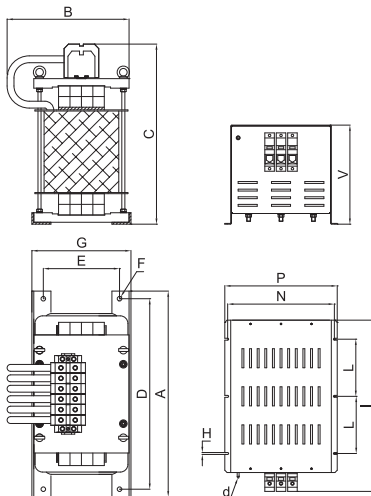

## MECHANICAL DIMENSIONS mm

FIN915SFH	A	B	C	D	E	F	G	I	L	N	P	V	H	d	S	Weight Kg.	Case
.480.M	540	340	475	500	200	12	260	620	660	244	295	262	16	M5	25x10	115	6
.610.M	540	340	475	500	200	12	260	620	660	244	295	262	16	M5	25x10	120	6
.680.M	540	340	475	500	200	12	260	830	790	244	292	292	16	M5	25x10	126	7
.770.M	540	340	475	500	200	12	260	830	790	244	292	292	16	M5	25x10	130	7
.860.M	540	340	475	500	200	12	260	885	830	474	520	292	16	M5	40x20	135	8
.960.M	540	340	475	500	200	12	260	885	830	474	520	292	16	M5	40x20	150	8
.1100.M	540	340	475	500	200	12	260	885	830	474	520	292	16	M5	40x20	200	8

## CASE 6, 7, 8

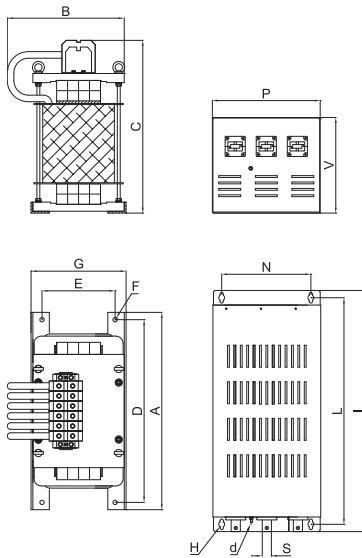



### 3-phase plus neutral star point snubber with excellent attenuation to reduce dV/dt

Datasheet 3/2019

**APPROVALS:**

**FIN47SNB.050.1M**
**FEATURES**

- Reduces dV/dt
- Protects motor windings, insulation and bearings
- Remote contact indicator
- Compact dimension due to the parallel installation

**BENEFITS**

- Very low power loss
- Available with remote electronic control
- Easy installation
- Only one model for unlimited HP motors

**MARKETS**

- Large motors
- Spindle motors
- Long cable applications with variable frequency drives or servo drives

**ORDERING CODE**

FIN47SNB	.050	.1M	.A	MSD1
Model	Impedance	Connection	Fan nominal voltage	Electronic control
		1M = 1 motor	A = 24Vdc B = 24Vac	MSD1 at 24Vdc
		2M = 2 motors	C = 110Vac D = 220Vac	MSD2 at 230Vac

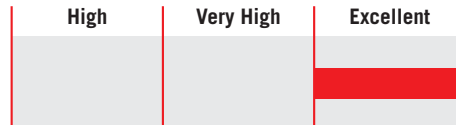
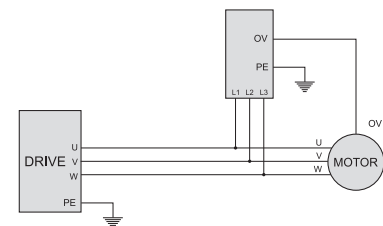
**ATTENUATION INDICATOR**

**ELECTRIC DIAGRAM**

**TECHNICAL SPECIFICATIONS**

Nominal voltage	0 / 600 Vac
Frequency	50 – 1000 Hz
Rated current	Unlimited
Carrier frequency (PWM)	Not applicable
Max peak voltage phase to phase	3000V
Max peak voltage phase to ground	3500V
Max power dissipation	250W
Fan dissipation	20W
IP protection	IP20
Climatic class	-40 / +85° C
MTBF at 40°C	250.000 Hrs.

### ELECTRICAL CHARACTERISTICS

FIN47SNB	Nominal Voltage AC (Vac)	Drive Carrier Frequency (kHz)	Power Loss at 100Hz (W)
.050.1M	600	<5	250

### CONNECTIONS

LINE			PE	
Solid Cable (mm <sup>2</sup> )	Stranded Cable (mm <sup>2</sup> )	Terminal Torque (Nm)	d (mm)	Torque (Nm)
10 - 50	10 - 50	4.0	M10	6

### TYPICAL MEASUREMENT

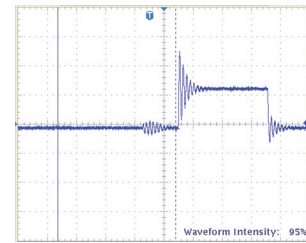

Typical measurement of  $dv/dt$  without snubber installed

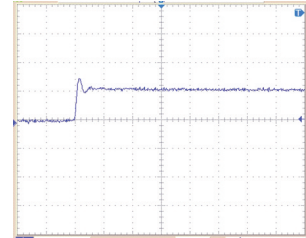

Typical measurement of  $dv/dt$  with snubber installed

### MECHANICAL DIMENSIONS mm

FIN47SNB	A	B	C	D	E	F	G	H	I	J	M	L	d	Weight Kg.	Case
.050.1M.X.Y	235	167	246.5	125	110	83	125	8.5	4	13.5	10	15	M10	5	1
.050.2M.X.Y	235	368	376.5	125	110	83	105	5.4	4	8.5	-	15	M10	10	2

### CASE 1

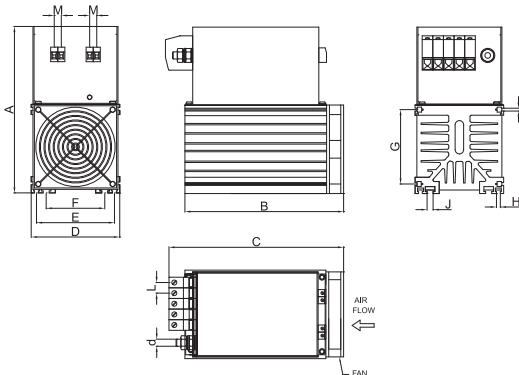

### CASE 2

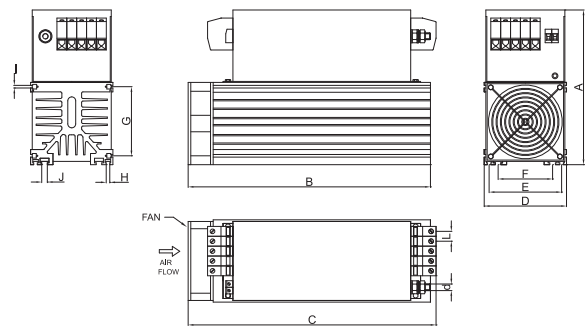



## Star point snubber with excellent attenuation to reduce dV/dt

Datasheet 3/2019



### FINSTP.(068 - 100).M100

#### FEATURES

- Reduces dV/dt star point -PE
- Protects motor windings, insulation and bearings
- Remote contact indicator
- Compact dimension due to the parallel installation

#### MARKETS

- Large motors
- Spindle motors
- Long cable applications with variable frequency drives or servo drives

#### APPROVALS:

 UL508  
CSA C22.2



#### BENEFITS

- Very low power loss
- Over temperature protection
- Easy installation
- Only one model for unlimited HP motors

#### ORDERING CODE

FINSTP	.068	.M100	.A
Model	Impedance	-	Fan nominal voltage
			A = 24Vdc
			B = 24Vac
			C = 110Vac
			D = 220Vac

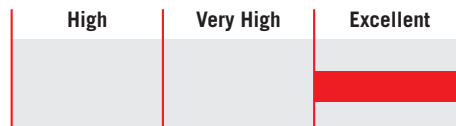
#### ATTENUATION INDICATOR



#### ELECTRIC DIAGRAM

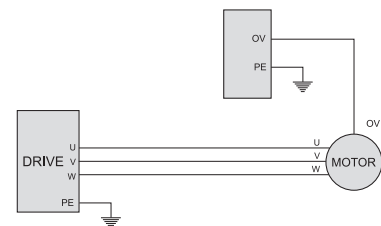

#### TECHNICAL SPECIFICATIONS

Nominal voltage	0 / 600 Vac
Frequency	50 – 1000 Hz
Rated current	Unlimited
Carrier frequency (PWM)	Not applicable
Max peak voltage phase to phase	3000V
Max peak voltage phase to ground	3500V
Max power dissipation	250W
Fan dissipation	20W
IP protection	IP20
Climatic class	-40 / +85° C
MTBF at 40°C	250.000 Hrs.

### ELECTRICAL CHARACTERISTICS

FINSTP	Nominal Voltage AC (Vac)	Drive Carrier Frequency (kHz)	Power Loss at 100Hz (W)
.068.M100	600	<5	200
.100.M100	600	<5	200

### CONNECTIONS

Solid Cable (mm <sup>2</sup> )	LINE		PE
	Stranded Cable (mm <sup>2</sup> )	Terminal Block Torque (Nm)	Torque (Nm)
10-50	10-50	4.0	6
10-50	10-50	4.0	6

### TYPICAL MEASUREMENT

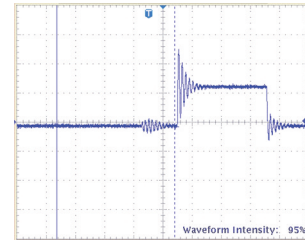

Typical measurement of dv/dt without snubber installed

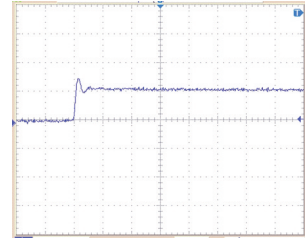

Typical measurement of dv/dt with snubber installed

### MECHANICAL DIMENSIONS mm

FINSTP	A	B	C	D	E	F	G	H	I	J	M	L	Weight Kg.	Case
.068.M100	190	167	185.5	125	110	83	105	5.4	4	8.5	10	20	4	1
.100.M100	190	167	185.5	125	110	83	105	5.4	4	8.5	10	20	4	1

### CASE 1

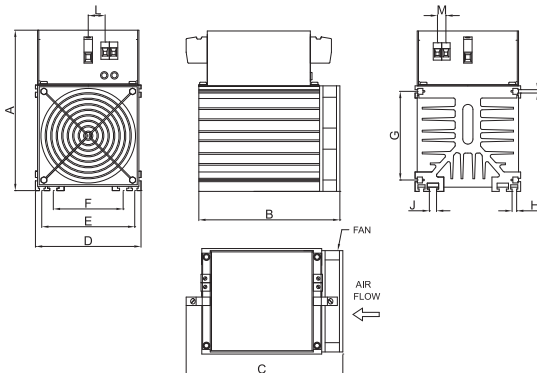



## High permeability toroid and ferrite core to reduce common mode noise

Datasheet 3/2019

**APPROVALS:**

**FEATURES**

- Insulation housing included
- FINTR with high permeability

**BENEFITS**

- Easy installation
- Ideal for radiated emission tests for the EN61000-6-4 Standard

**FINTR.(3600 - 14000)**  
**FINFE.13**

**MARKETS**

- Indoor and outdoor applications

**ORDERING CODE**

FINTR .4900  
Model  
TR = Toroid Size  
FE = Ferrite

FINTR	Permeability $\mu$
.3600	5000
.4900	10000
.6300	10000
.10000	5500
.14000	5500

**MECHANICAL DIMENSIONS mm**

FINTR	A	B	C	Weight Kg.	Case
.3600	37	22	16	0.04	1
.4900	49	34	16	0.08	1
.6300	63	38	25	0.25	1
.10000	102	66	15	0.36	1
.14000	140	106	25	0.80	1

FINFE	A	B	C	D	Weight Kg.	Case
.13	31	32	13	33	0.1	2

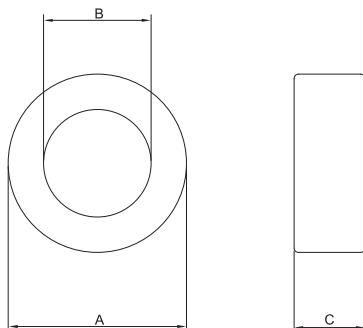
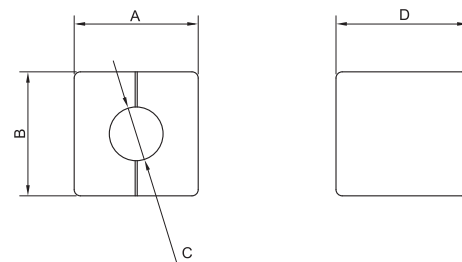
**CASE 1**

**CASE 2**



Enerdoor accessories include the FINPRT and FINENCL series.

FINPRT offers finger safe protection for EMI/RFI filters with bus bar connections and features easy installation.

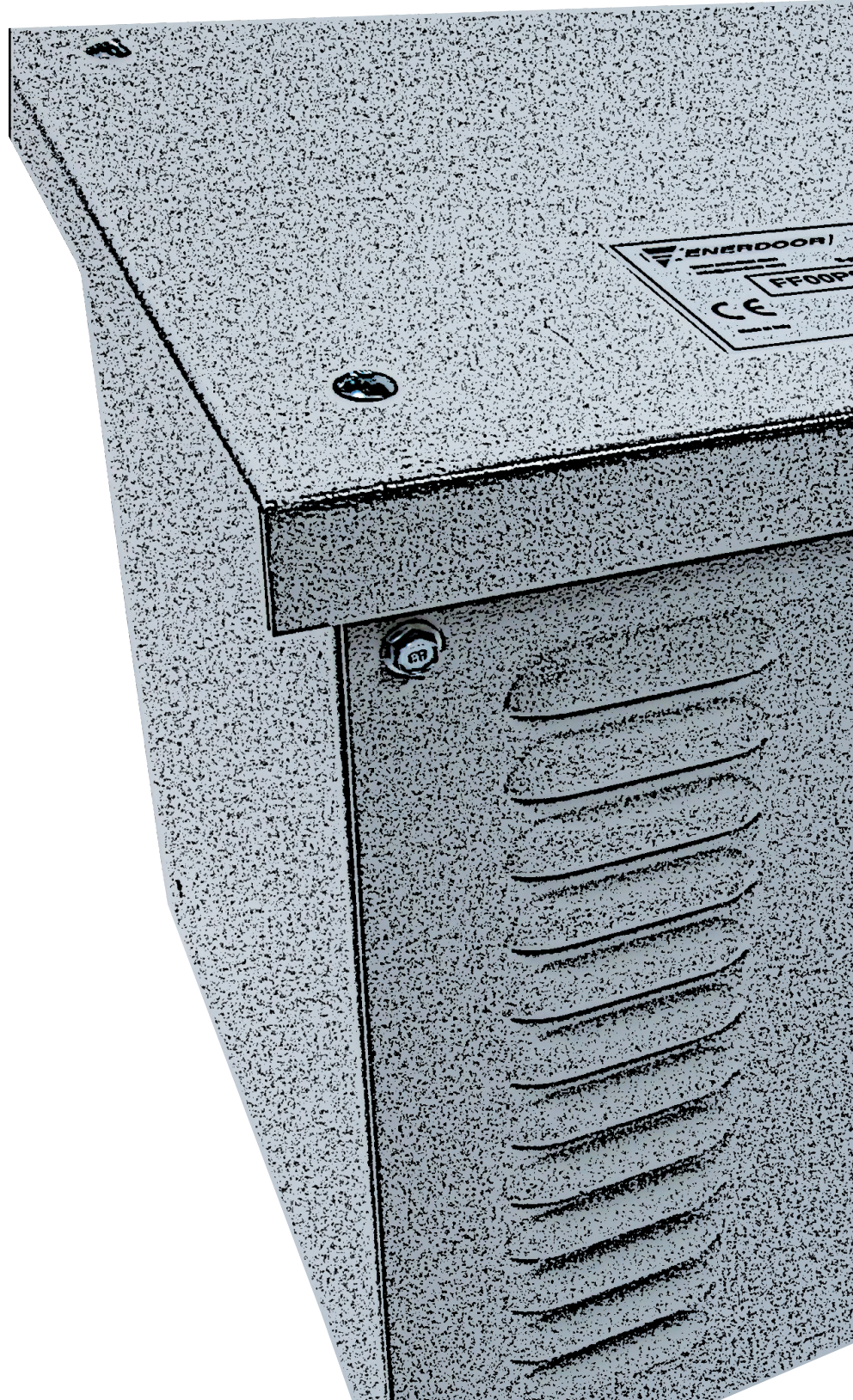
Enerdoor FINENCL series features enclosures in IP21 (Nema 1) and IP44 (Nema 3R) for indoor and outdoor installations. These accessories are typically used for any type of line reactors, output filters and sine wave filters. Features include easy installation and an optional fan.





## Protection covers for filters with high currents and bus bar connections

Datasheet 3/2019

**APPROVALS:**

**FEATURES**

- Rated current from 150 to 1750A

**BENEFITS**

- Easy installation
- Increases IP protection

**MARKETS**

- Enerdoor filter with bus bar connection

**ORDERING CODE**

FINPRT	.250	.P
Model	Size	Connection
		P = Protection

**FINPRT.(250 - 1000).P**

FINPRT	FIN1200 / FIN1200HV	FIN1500 / FIN1500HV	FIN538S1	FIN539S
.250.P	.150.V	.150.V	.150.V	-
	.200.V	.200.V	.200.V	.200.V
	.280.V	.280.V	.280.V	.280.V
	.280.BC	.280.BC	.280.BC	.280.BC
	.320.BC	.320.BC	.320.BC	.320.BC
.360.P	.360.BC	.360.BC	.360.BC	.400.B
	.400.BC	.400.BC	.400.BC	.500.B
	.500.BC	.500.BC	.500.BC	.600.B
	.600.BC	.600.BC	.600.BC	.750.B
	.750.BC	.750.BC	.750.BC	.900.B
.750.P	.900.BC	.900.BC	.900.BC	.1000.B
	.1000.BC	.1000.BC	.1000.BC	.1250.B
	.1250.BC	.1250.BC	.1250.BC	.1500.B
.1000.P	.1500.BC	.1500.BC	.1500.BC	.1750.B
	.1600.BC	.1600.BC	.1600.BC	.2000.B
	.1750.BC	.1750.BC	.1750.BC	.2250.B

**MECHANICAL DIMENSIONS mm**

FINPRT	A	B	C	D	E	Case
.250.P	135	115	250	270	110	1
.360.P	135	115	260	280	150	1
.750.P	165	145	280	300	180	1
.1000.P	165	145	380	400	200	1

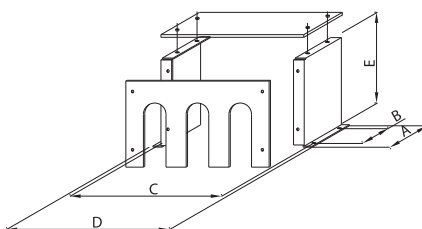
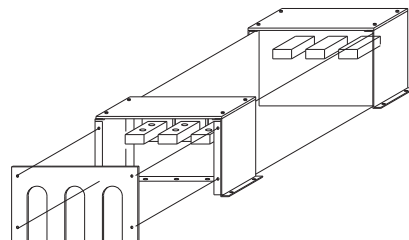
**CASE 1**

**ASSEMBLY**



## Enclosure series for line reactors, high frequency inductance and sine wave filters

Datasheet 3/2019

**APPROVALS:**

**FINENCL.(31 - 101)**
**FEATURES**

- Different IP protections available
- Used for line reactors, output filters and sine wave filters

**BENEFITS**

- Easy installation
- Fan available upon request



**FINECL.(A - D)**
**MARKETS**

- Indoor and outdoor applications

**ORDERING CODE**

COF .31  
Model Size

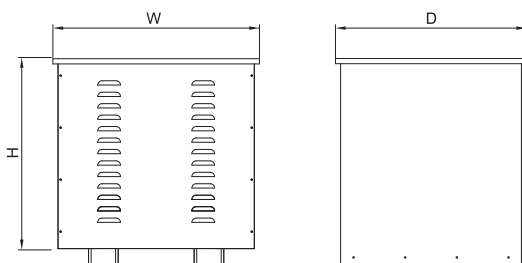
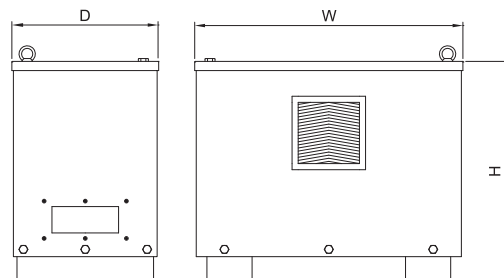
FINENCL	IP Protection (Nema)	W	D	H	Weight Kg.	Case
.31	IP21 (Nema 1)	340	340	330	7	1
.41	IP21 (Nema 1)	340	340	380	9	1
.51	IP21 (Nema 1)	390	390	430	12	1
.61	IP21 (Nema 1)	490	370	480	16	1
.71	IP21 (Nema 1)	540	440	590	22	1
.81	IP21 (Nema 1)	640	490	695	30	1
.101	IP21 (Nema 1)	800	800	800	43	1
.A	IP44 (Nema 3R)	450	360	620	23	2
.B	IP44 (Nema 3R)	610	460	720	35	2
.C	IP44 (Nema 3R)	810	560	920	56	2
.D	IP44 (Nema 3R)	1306	1000	1426	95	2

**CASE 1**

**CASE 2**



## EMI/RFI Filters: Overview

EMI/RFI filters reduce electromagnetic conducted and radiated interference. For a typical representation of an EMI/RFI filter, please see **Figure 4**.

These filters are bi-directional devices and reduce undesirable signals measured on output terminals in comparison with those that appear on input terminals or vice versa. Due to bi-directional characteristics, EMI/RFI filters are able to reduce levels of emitted disturbances and also increase the immunity level of filtered equipment or systems.

### 1.1 Active and passive filters

- Active filters are devices in which mainly active components are used, such as transistors
- Passive filters are devices in which only passive components as resistances, inductances and capacitors are used

### 1.2 Single phase and three phase filters

- Single phase filters are suitable for application on single phase equipment or electric installations (See **Figure 5**)
- Three phase filters are suitable for application on three phase equipment or electric installations (See **Figure 6**)

### 1.3 Single and double function filters

- Single function filters are RFI devices able to efficiently attenuate common mode interference. The electrical diagram of the Enerdoor single function filter type FIN538 is shown in **Figure 7**. This type of filter typically allows a maximum attenuation level of common mode interference of 70-80 dB.
- Double function filters efficiently attenuate both common mode and differential mode interference. The electrical diagram of the Enerdoor double function filter type FIN1500 is shown in **Figure 8**. This type of filter allows a maximum attenuation level of interference higher than 80 dB.

The following single phase filters are double function filters: FIN33, FIN35, FIN40 and FIN50.

The following three phase filters are double function filters: FIN538S, FIN538S1, FIN1200, FIN1500, FIN1600, FIN1700, FIN1900, FIN1740, and FIN1940.

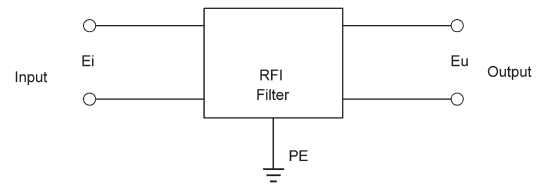

$$Eu < Ei = \text{Attenuation}$$

Fig. 4: Typical representation of an EMI/RFI filter

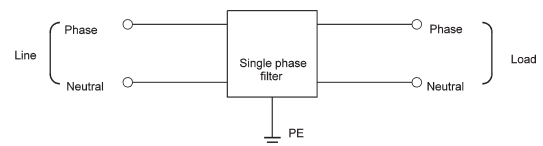

Fig. 5: Schematic diagram of a single phase filter

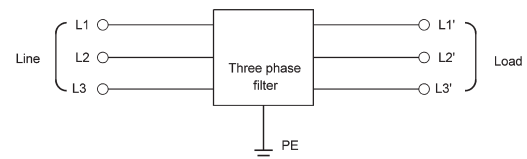

Fig. 6: Schematic diagram of a three phase filter

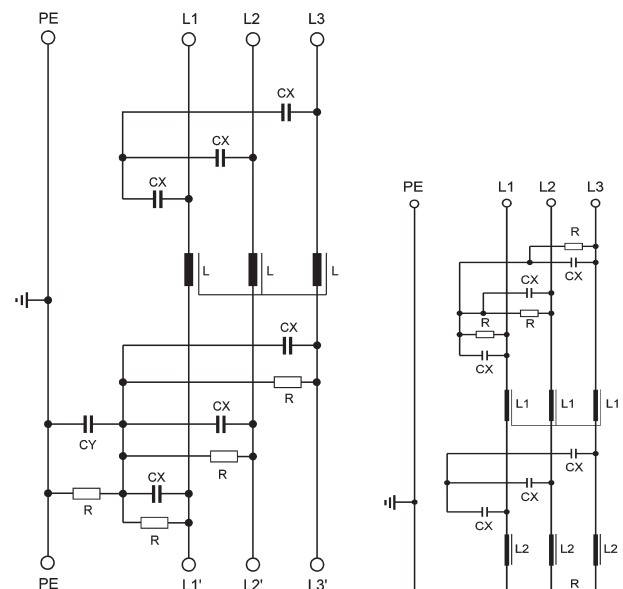

Fig. 7: Electrical diagram of Enerdoor single stage filter type FIN538

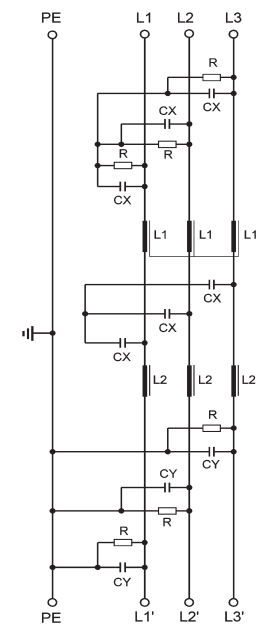

Fig. 8: Electrical diagram of Enerdoor double stage filter type FIN1500

## 1.4 Series and parallel filters

a) Series filters represent the most widespread RFI filters and are typically connected in series between the energized electric point and the load. The total load current flows through the inductive components of a series filter and therefore must be suitable to support the load (See **Figure 9**). Capacitive and resistive components of this filter are connected in parallel and absorb a very low current from the main.

The following RFI filters are three phase filters: FIN538, FIN538S, FIN538S1, FIN539S, FIN1200, FIN1500, FIN1600, FIN1700, FIN1900, FIN3755, FIN1240, FIN1740, FIN1740ESM, and FIN1940.

The following RFI filters are single phase filters: FIN21, FIN26, FIN27, FIN33, FIN35, FIN40, FIN50, FIN60, FIN70 and FIN80.

b) Parallel filters are connected in parallel to the main; therefore their inductive, resistive and capacitive components absorb only a small current independent of the level of load current. The typical application of single function FIN130SP, FIN230SP, FIN730, FIN735, and FIN740 parallel filters are shown in **Figure 10**.

These parallel filters have been developed by Enerdoor to increase the attenuation level for lower frequency interference. In particular those included in the range between a few kHz and a few MHz, and protect electronic control devices of industrial automatic machines from short duration high voltage surges.

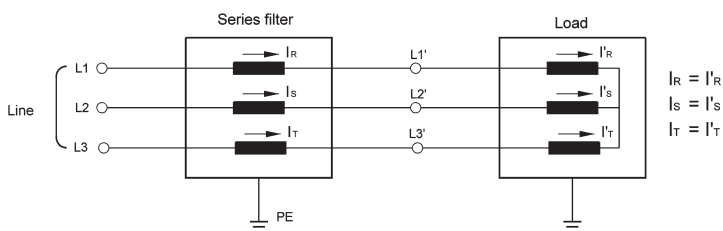

Fig. 9: Example of connection of a series filter: the total load current flows through the inductive components of the filter.

Note: An example of a simple series filter is represented by a common mode choke (for example an Enerdoor choke series FIN900) to be connected between the inverter and the load.

The above choke application allows an important reduction of radiated interference and a lower attenuation of the conducted interference present on the mains.

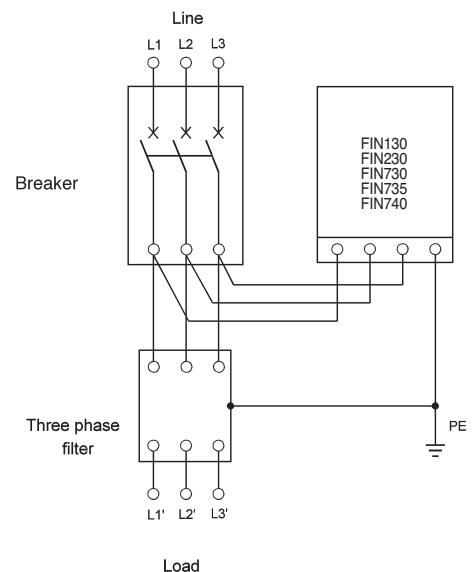

Fig. 10: Application diagram of single stage Enerdoor FIN730 and FIN230SP parallel filters

## 2. Normative References

### 2.1 European EMC Framework I Directive 2014/30/EU

In accordance with the European Framework 2014/30/EU relevant to Electromagnetic Compatibility (EMC), each device, machine or installation containing electric components which emit interference or disturbed by them shall:

- a) Not generate electromagnetic disturbance levels higher than that established by the above Directive, in order to allow the correct operation of all equipment installed in the surrounding environment.
- b) Comply with the Standard level of immunity, in order to avoid electromagnetic disturbance influencing behavior in service.

### 2.2 Normative references for emission and immunity tests

In order to certify that a device, machine or installation complies with the European Directive EMC 2014/30/EU, it is necessary to carry out a complete series of electromagnetic compatibility tests.

#### A) EMISSION TEST

STANDARD REFERENCE	TYPE OF EMC TEST
EN 55014	Conducted emissions
EN 55014	Radiated power
EN 55014	Intermitted interference (click)
EN 55011	Conducted emissions
EN 55011	Radiated emissions
EN 55022	Conducted emissions
EN 55022	Radiated emissions

#### B) IMMUNITY TEST

STANDARD REFERENCE	TYPE OF EMC TEST
EN 61000-4-2	Electrostatic discharge immunity
EN 61000-4-3	RF radiated immunity
EN 61000-4-4	Immunity to fast transients (burst)
EN 61000-4-5	Immunity to high energy transients (surge)
EN 61000-4-6	Conducted immunity
EN 61000-4-8	Power frequency magnetic field immunity
EN 61000-4-11	Immunity to voltage dips and variations

### 3. Classification of industrial environments in accordance with the EMC level

#### 3.1 General

Electromagnetic interference may originate inside or outside a device, machine or installation.

The interference of internal origin mainly causes electromagnetic emission problems, while those of external origin can cause immunity problems. EMI/RFI filters must be capable of adequately reducing both internal and external disturbances in order to solve the entire electromagnetic compatibility problem on the device, machine or installation.

#### 3.2 EMC environment classifications

In order to determine the most adequate EMI/RFI filter relevant to a specific application, environments are classified in accordance with the EMC interference levels and are as follow:

- Normal (low EMC interference levels)
- Severe (medium EMC interference levels)
- Very severe (high EMC interference levels)

Emission and immunity tests (See Clause 2.2) verify that a device, machine or installation is adequate for a specific EMC environment.

### 4. Enerdoor EMI/RFI filters in accordance with EMC environments

#### 4.1 Residential, commercial and light industrial environment

Enerdoor filters used for:

- Single phase circuits: FIN21, FIN26, FIN27, FIN 40, FIN50
- Three phase circuits: FIN538, FIN538S, FIN538S1, FIN1200, FIN1700, FIN1700E, FIN1700G, FIN1700EG, FIN3755 double function filters

#### 4.2 Industrial environments (Severe environment)

Enerdoor filters used for:

- Single phase circuits: FIN27, FIN 35, FIN40, FIN50
- Three phase circuits: FIN538, FIN538S, FIN538S1, FIN1200 (HV\*), FIN1500 (HV\*), FIN1600, FIN1700, FIN1700E, FIN1700EG, FIN1900, FIN1900E, FIN1900G, FIN1900EG, FIN1900S, FIN3755, FIN1240, FIN1740, FIN1740ESM, FIN1940 double function filters

#### 4.3 Industrial environment (Very severe environment)

Enerdoor filters used for:

- Single phase circuits: FIN27, FIN35, FIN40, FIN50
- Three phase circuits: FIN538, FIN538S, FIN538S1, FIN539S, FIN1200 (o HV\*), FIN1500 (o HV\*), FIN1600, FIN1700, FIN1700E, FIN1700EG, FIN1900, FIN1900E, FIN1900G, FIN1900EG, FIN1900S, FIN3755, FIN1240, FIN1740, FIN1740ESM, FIN1940 double function filters; FIN130SP, FIN230SP, FIN730, FIN735, FIN740

#### 4.4 Filters for a specific application

The information referenced above is a general suggestion relevant to the application of Enerdoor filters. A more precise match between a device, machine or installation and an RFI filter may be determined only after having carried out the complete series of emission and immunity EMC tests.

(\*) The FIN1200HV and FIN1500HV filters offer the same attenuation characteristics as the FIN1200 and FIN1500 but have nominal voltage of 600V – 50 Hz instead of 480V – 50 Hz.

## 5. Application example for Enerdoor filters and chokes

In the schematic diagram Figure 11 the choice of the best filter(s) for the specific application may vary using the below criteria.

### 5.1 Filter parameters

a) The power reference of the filter:

$$P = \sqrt{3} V \cdot I \cos \varphi$$

<b>P</b>	Is the total power of device and motor of the considered system
<b>V</b>	Is the phase to phase nominal voltage of the installation (for example 400V-50 Hz)
<b>cos φ</b>	Is the average power factor

b) The nominal current (I) of the filter derives from the previous formula, as follows:

$$I = \frac{P}{\sqrt{3} \cdot V \cdot \cos \varphi}$$

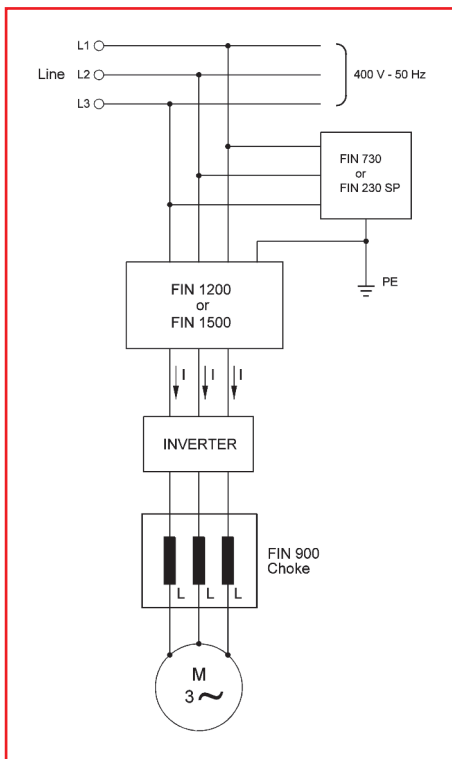

Fig. 11:  
Typical electric  
diagram  
relevant to the  
application of  
Enerdoor  
filters and  
chokes

Note: The low  
voltage  
breaker is not  
represented

### 5.2 Calculation example (See Figure 11)

What is the best Enerdoor filter for an installation with total power P of 85 kW and phase to phase voltage of 400 Volts?

a) It is assumed the power factor **cos φ** value is 0.7  
Knowing the power **P**, the voltage **V**, and the **cos φ**, the  
current value is calculated as follows:

$$I = \frac{P}{\sqrt{3} \cdot V \cdot \cos \varphi} = \frac{85,000}{\sqrt{3} \cdot 400 \cdot 0.7} \approx 175 \text{ A}$$

Therefore the best Enerdoor filter for this specific application is one with the nominal current of 200A.

In accordance with the EMC environment (typically severe or very severe), a two stage series filter in combination with a single stage parallel filter is recommended.

b) The choke installed between the inverter and the motor shall have a nominal current higher than that calculated for the filter. This is due to the following effects:

- The working frequency PWM of the inverter is between 5 and 20 kHz. This causes an augmentation of choke loss and consequently increases temperature.
- During the motor acceleration and deceleration the output current of the inverter may be double its nominal value for up to one minute..

Practical experience suggests using a choke about 50% larger compared to the corresponding RFI filters nominal current. Therefore, for this application an Enerdoor choke with nominal current equal to 280A is recommended.



### Example of a filter application on a system with one master cabinet and several auxiliary cabinets

In this case a single mains filter is installed on the master cabinet only.

Note: Power cables leaving a filtered cabinet are always screened with the screen earthed at both ends.

Shielded signal cables, however, have screens earthed at the electronic board end only.

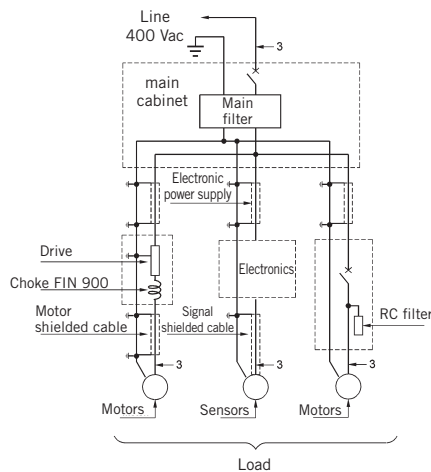

### Example of filter application with brushless drives

Note: Presence of the mains filter in series with the power supply at the panel input; cell in parallel with the filter on the mains side; chokes on the drive output; screened motor cable with the cable screen connected to earth at both ends (if possible with the earth conductor external to the screen).

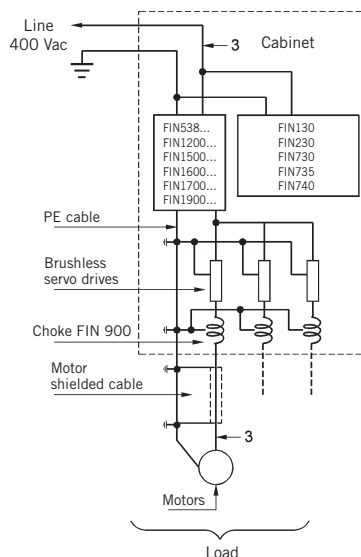

### Example of filter application in a plant using more cabinet

A single cell covers the entire plant.

Each cabinet is equipped with its own filter.

The filter may be omitted on panels which do not contain components generating high disturbance levels (such as asynchronous motors).

Note: The RC filter on the asynchronous motor remote control breaker is necessary to eliminate the disturbance on the motor cable generated by contact opening.

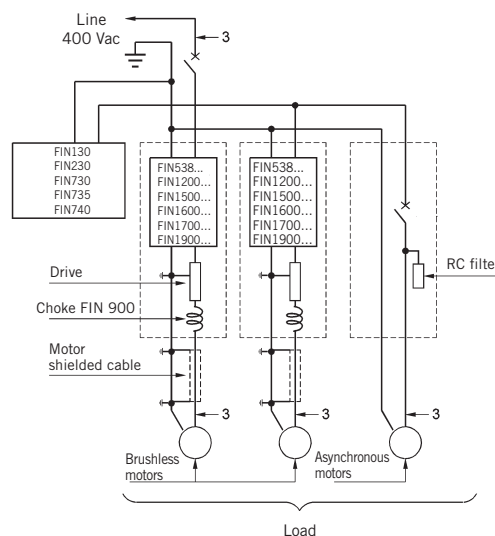

**Reactance application example:**

- a) with one generic driver system
- b) with one SCR driver system which pilots two motors

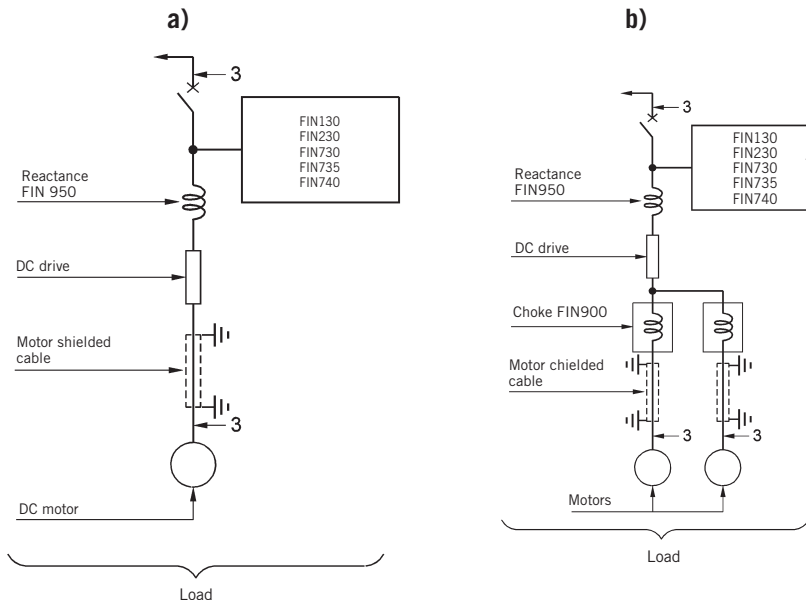

**Figure 1**

In **Example A** the application of the filter feeding only the driver/inverter is technically correct. However, there exists a risk that inside the cableform cable 1 may run parallel to and nearby cable 2 and 3. In this case, cable 1 becomes coupled to cable 2 and 3, inducing in the latter disturbances which are transmitted to the mains network and reduces the effectiveness of the filter. It is therefore better to use the solution shown in **Example B**. The only precaution needed is to avoid the close proximity and parallel run of cables 1 and 2, which would induce in the latter the phenomenon previously explained.

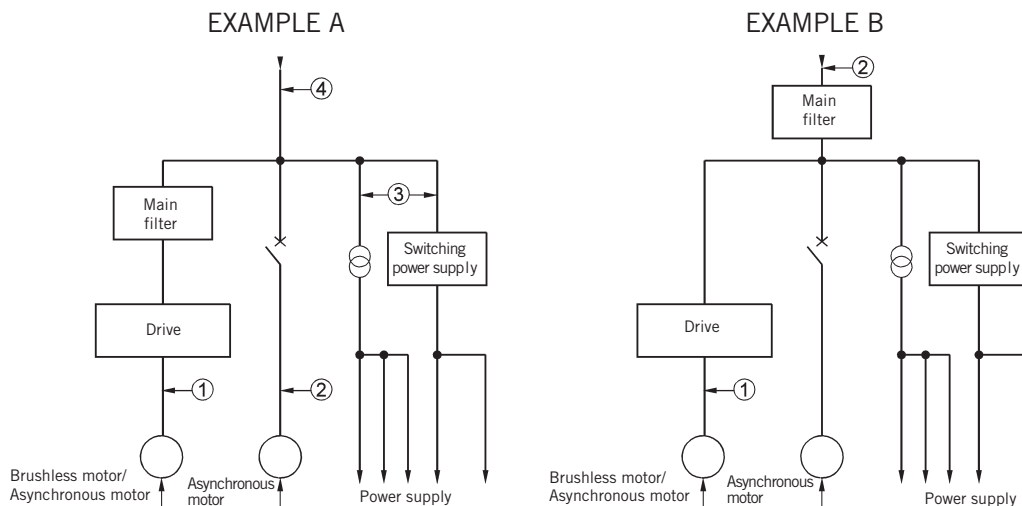

**Figure 2**

In this example the application of the filter is correct. **System 2** which does not incorporate disturbing components is not filtered. However, for the reason stated in connection with **Figure 1**, it is necessary to avoid that outside the system cable 1 runs parallel and close to cables 2, 3 and 4.

The coupling would induce disturbance in the latter which, transmitted to the mains network, would reduce the filters effectiveness.

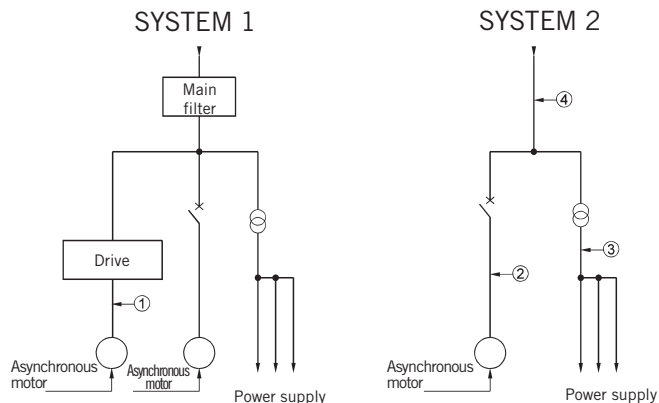
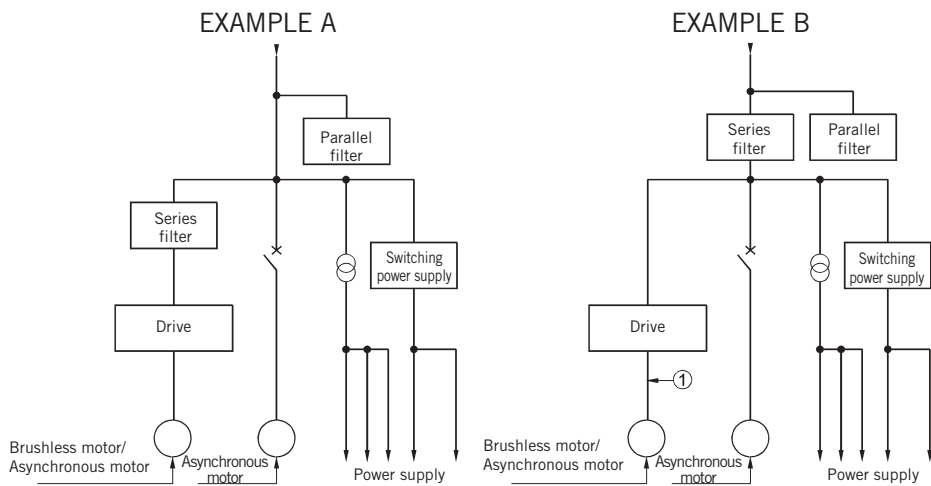

**Figure 3**

In **Example A** the EMI/RFI Filter series is installed only in a portion of the machine, the parallel filter must be connected immediately after the main breaker of the panel and as close as possible to the main grounding collector.

In **Example B** the parallel filter is connected in parallel to the input of the mains filter.

In both cases the wires connecting the parallel filter must be as short as possible



The present General Application Instructions are intended as a general guide for the correct use of interference suppressing filters and chokes under safe conditions.

**F**ilters must be installed, protected and used correctly in order to avoid dangers. Filters must be employed satisfying the conditions of use for which they were designed and guaranteed. Filters must not be exposed to chemical substance damage, unless specifically designed to withstand such substances. Examples of damaging substances are as follow but not limited to: solvents, oils, grease, base or acid solutions, and chemical products. Filters must be adequately protected against the risk of mechanical damage both during installation and under normal working conditions. Filters must not be installed in places subject to rainfall or in contact with water, unless expressly declared to be suitable for withstanding such conditions. Particular attention should be paid to not exposing filters to polluted atmospheres or harmful substances. Filters are designed for use in closed spaces, usually inside electrical cubicles. They may be used outside stated enclosures but only when the necessary protection is supplied.

#### **GENERAL INSTALLATION REQUIREMENTS**

In the absence of specific installation instructions, the following rules are to be applied: Connections must scrupulously follow the technical information and must be carried out using suitable tools / fixtures. Metallic containers must be suitably grounded. Filters must not be installed in contact with, or close to, hot surfaces. If employed in such conditions they must be suitably prepared, allowing a 10% degrading for each 20°C, up to a maximum of 30% at 100°C. The Enerdoor Service Center must be contacted if such a non-standard application is used. Filters must be adequately supported and must not be damaged by mechanical supporting devices. The contact terminals of filters must have suitable clamps at the cable-to-filter contact terminals in order to ensure terminals will not become disconnected as a result of vibrations. Clamping must be precise and periodically inspected. When filters are installed on mobile structures they must be placed in protective housing which guarantee the mechanical and electrical protection of the filter connecting terminals. If filters and coils are connected using screened cables, the length of the unscreened portion of the cable must be kept to the minimum. Filters and coils must not be subjected to the following mechanical stresses: pulling, twisting, compression, squashing and scraping.

#### **GENERAL USE REQUIREMENTS**

As for the limiting conditions of a filters use: the nominal voltage, current capacity, working temperature and thermal effect references must be made to defined technical specifications. Current and voltage specifications assume an ambient temperature of 40°C. Characteristics quoted in product specifications must always be consulted and it is recommended that stated specifications be scrupulously respected particularly concerning specified parameters.

#### **PERIODIC CHECKS BY THE PURCHASERS**

Filters must be periodically examined. Examination is required whenever there is a fear there might be damage by electrical stress (overvoltage, overload) or mechanical stress (squashing, twisting, scraping, etc.). If a filter shows visible changes in appearance or signs of damage or wear, it must be repaired by skilled and qualified personnel using suitable facilities, or it must be replaced. Filters mounted on mobile or portable structures should be examined after each spell of duty. A period of 2 years between routine inspections is suggested.

#### **STORAGE CONDITIONS**

All filters, not specifically designed for external use, must be stocked in closed dry storage space.

**SPECIFICATIONS ARE SUBJECT TO CHANGE WITHOUT NOTICE.**

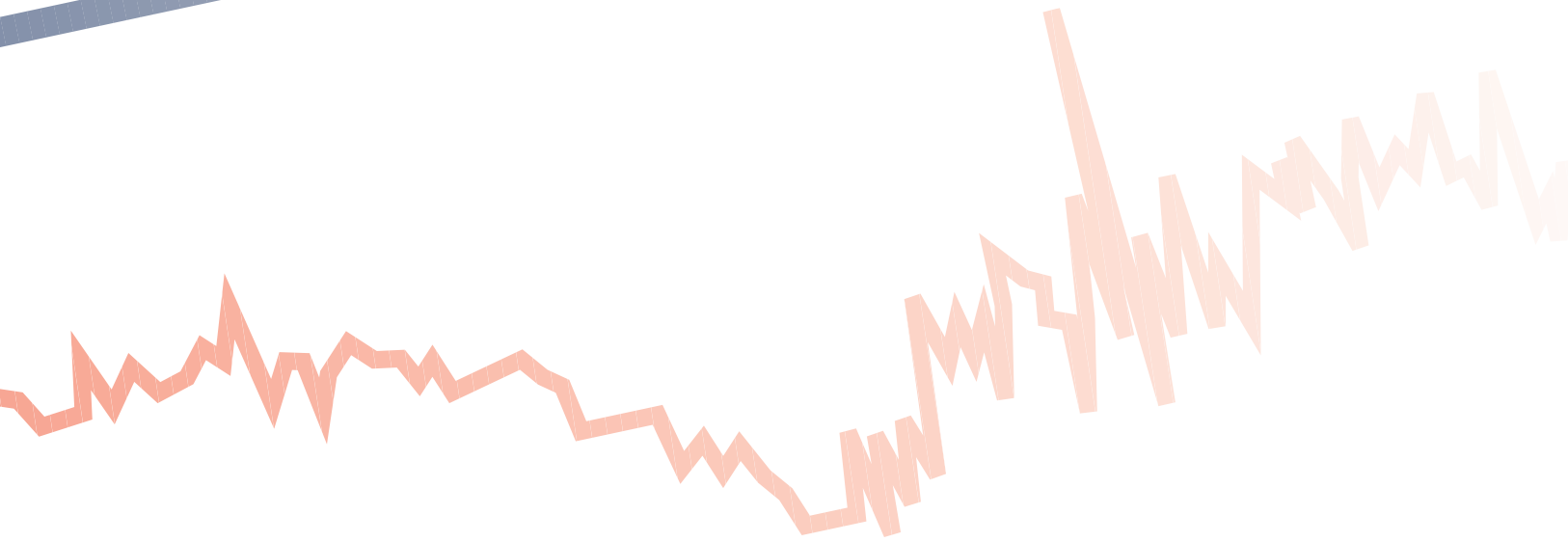
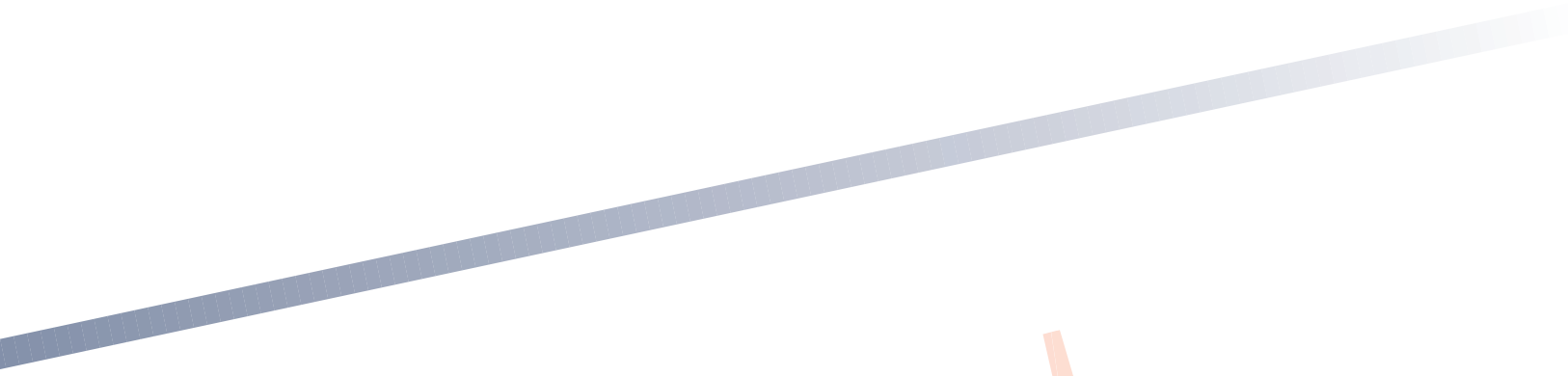



**SWITZERLAND**  
**ENERDOOR SA**  
 Phone +41 (0) 91 9228060  
 info@enerdoor.ch  
 www.enerdoor.ch

**USA**  
**ENERDOOR Inc**  
 Toll Free 1-877-778-2875  
 Phone 1-207-210-6511  
 info@enerdoor.com  
 www.enerdoor.com

**GERMANY**  
**ENERDOOR GmbH**  
 Phone +49 (0) 6642 223692  
 info@enerdoor.de  
 www.enerdoor.de

**ITALY**  
**FINMOTOR Srl**  
 Phone +39 02 4891 0020  
 info@finmotor.com  
 www.finmotor.com

**FINLAB**  
 Phone + 39 4890462  
 info@finlab.it  
 www.finlab.it

**HUNGARY**  
**EICHHOFF ELEKTRO Kft**  
 Phone +36 27 511180  
 info@eichhoff-elektro.com  
 www.eichhoff-kft.com